

MMBT6428LT1, MMBT6429LT1

Amplifier Transistors

NPN Silicon

Features

- Pb-Free Packages are Available

MAXIMUM RATINGS

| Rating | Symbol | 6428LT1 | 6429LT1 | Unit |
|--------------------------------|-----------|---------|---------|------|
| Collector-Emitter Voltage | V_{CEO} | 50 | 45 | Vdc |
| Collector-Base Voltage | V_{CBO} | 60 | 55 | Vdc |
| Emitter-Base Voltage | V_{EBO} | 6.0 | | Vdc |
| Collector Current - Continuous | I_C | 200 | | mAdc |

Maximum ratings are those values beyond which device damage can occur. Maximum ratings applied to the device are individual stress limit values (not normal operating conditions) and are not valid simultaneously. If these limits are exceeded, device functional operation is not implied, damage may occur and reliability may be affected.

THERMAL CHARACTERISTICS

| Rating | Symbol | Value | Unit |
|---|-----------------|-------------|----------------------------|
| Total Device Dissipation FR-5 Board (Note 1) $T_A = 25^\circ\text{C}$ Derate above 25°C | P_D | 225 | mW |
| Thermal Resistance, Junction-to-Ambient | $R_{\theta JA}$ | 1.8 | $\text{mW}/^\circ\text{C}$ |
| Total Device Dissipation Alumina Substrate, (Note 2) $T_A = 25^\circ\text{C}$ Derate above 25°C | P_D | 300 | mW |
| Thermal Resistance, Junction-to-Ambient | $R_{\theta JA}$ | 2.4 | $\text{mW}/^\circ\text{C}$ |
| Thermal Resistance, Junction-to-Ambient | $R_{\theta JA}$ | 417 | $^\circ\text{C}/\text{W}$ |
| Junction and Storage Temperature | T_J, T_{stg} | -55 to +150 | $^\circ\text{C}$ |

- FR-5 = $1.0 \times 0.75 \times 0.062$ in.
- Alumina = $0.4 \times 0.3 \times 0.024$ in. 99.5% alumina.



ON Semiconductor®

<http://onsemi.com>

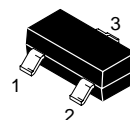
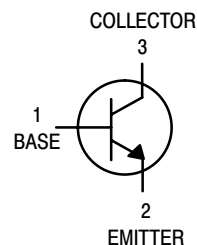

SOT-23 (TO-236)
CASE 318
STYLE 6

MARKING DIAGRAM

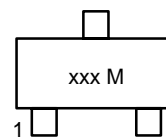

xxx = Specific Device Code
MMBT6428LT1 - 1KM
MMBT6429LT1 - 1L
M = Date Code

ORDERING INFORMATION

| Device | Package | Shipping† |
|--------------|---------------------|------------------|
| MMBT6428LT1 | SOT-23 | 3000 Tape & Reel |
| MMBT6428LT1G | SOT-23 (Pb-Free) | 3000 Tape & Reel |
| MMBT6429LT1 | SOT-23 | 3000 Tape & Reel |
| MMBT6429LT1G | SOT-23 (Pb-Free) | 3000 Tape & Reel |

†For information on tape and reel specifications, including part orientation and tape sizes, please refer to our Tape and Reel Packaging Specifications Brochure, BRD8011/D.

MMBT6428LT1, MMBT6429LT1

ELECTRICAL CHARACTERISTICS (T_A = 25°C unless otherwise noted)

| Characteristic | | Symbol | Min | Max | Unit |
|---|----------|----------------------|-----|------|------------------|
| OFF CHARACTERISTICS | | | | | |
| Collector–Emitter Breakdown Voltage (I _C = 1.0 mA _{dc} , I _B = 0) (I _C = 1.0 mA _{dc} , I _B = 0) | MMBT6428 | V _{(BR)CEO} | 50 | – | V _{dc} |
| | MMBT6429 | | 45 | – | |
| Collector–Base Breakdown Voltage (I _C = 0.1 mA _{dc} , I _E = 0) (I _C = 0.1 mA _{dc} , I _E = 0) | MMBT6428 | V _{(BR)CBO} | 60 | – | V _{dc} |
| | MMBT6429 | | 55 | – | |
| Collector Cutoff Current (V _{CE} = 30 V _{dc}) | | I _{CES} | – | 0.1 | μA _{dc} |
| Collector Cutoff Current (V _{CB} = 30 V _{dc} , I _E = 0) | | I _{CBO} | – | 0.01 | μA _{dc} |
| Emitter Cutoff Current (V _{EB} = 5.0 V _{dc} , I _C = 0) | | I _{EBO} | – | 0.01 | μA _{dc} |

ON CHARACTERISTICS

| | | | | | |
|---|----------|----------------------|------|------|-----------------|
| DC Current Gain (I _C = 0.01 mA _{dc} , V _{CE} = 5.0 V _{dc}) (I _C = 0.1 mA _{dc} , V _{CE} = 5.0 V _{dc}) (I _C = 1.0 mA _{dc} , V _{CE} = 5.0 V _{dc}) (I _C = 10 mA _{dc} , V _{CE} = 5.0 V _{dc}) | MMBT6428 | h _{FE} | 250 | – | – |
| | MMBT6429 | | 500 | – | |
| | MMBT6428 | | 250 | 650 | |
| | MMBT6429 | | 500 | 1250 | |
| Collector–Emitter Saturation Voltage (I _C = 10 mA _{dc} , I _B = 0.5 mA _{dc}) (I _C = 100 mA _{dc} , I _B = 5.0 mA _{dc}) | | V _{CE(sat)} | – | 0.2 | V _{dc} |
| | | | – | 0.6 | |
| Base–Emitter On Voltage (I _C = 1.0 mA _{dc} , V _{CE} = 5.0 mA _{dc}) | | V _{BE(on)} | 0.56 | 0.66 | V _{dc} |

SMALL–SIGNAL CHARACTERISTICS

| | | | | | |
|---|--|------------------|-----|-----|-----|
| Current–Gain – Bandwidth Product (I _C = 1.0 mA _{dc} , V _{CE} = 5.0 V _{dc} , f = 100 MHz) | | f _T | 100 | 700 | MHz |
| Output Capacitance (V _{CB} = 10 V _{dc} , I _E = 0, f = 1.0 MHz) | | C _{obo} | – | 3.0 | pF |
| Input Capacitance (V _{EB} = 0.5 V _{dc} , I _C = 0, f = 1.0 MHz) | | C _{ibo} | – | 8.0 | pF |

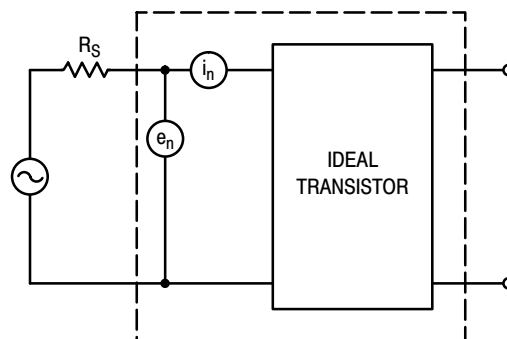

Figure 1. Transistor Noise Model

MMBT6428LT1, MMBT6429LT1

NOISE CHARACTERISTICS

($V_{CE} = 5.0 \text{ Vdc}$, $T_A = 25^\circ\text{C}$)

NOISE VOLTAGE

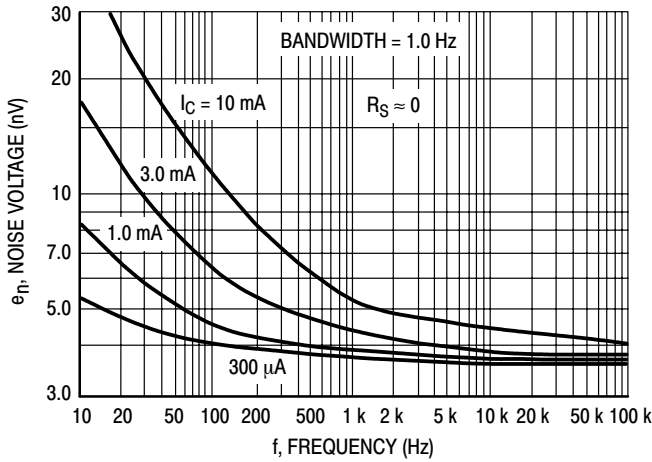

Figure 2. Effects of Frequency

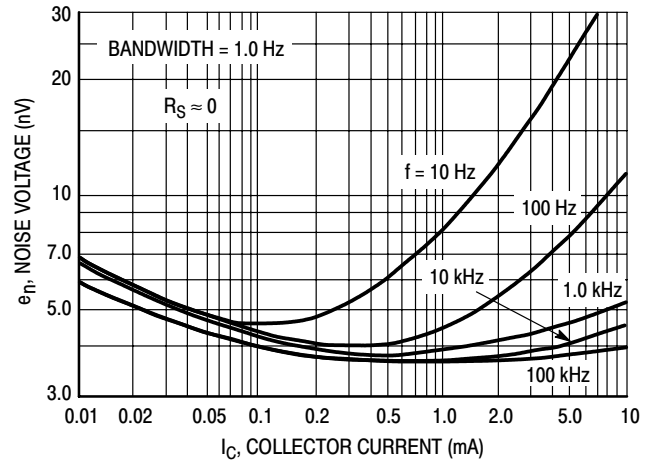

Figure 3. Effects of Collector Current

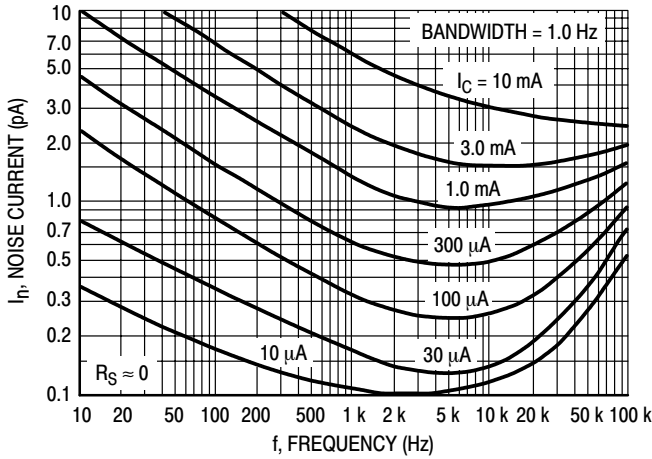

Figure 4. Noise Current

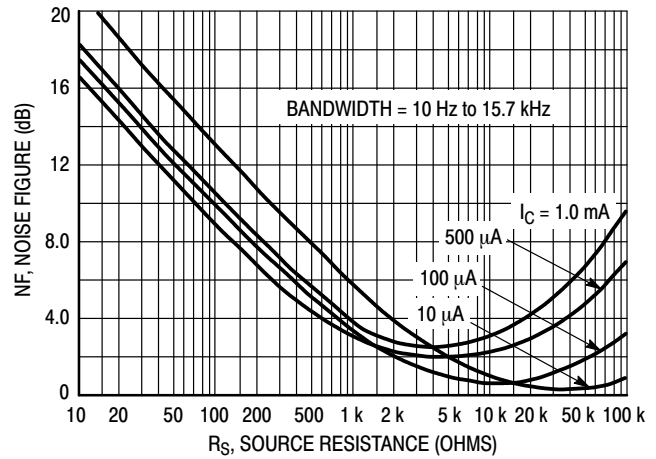

Figure 5. Wideband Noise Figure

100 Hz NOISE DATA

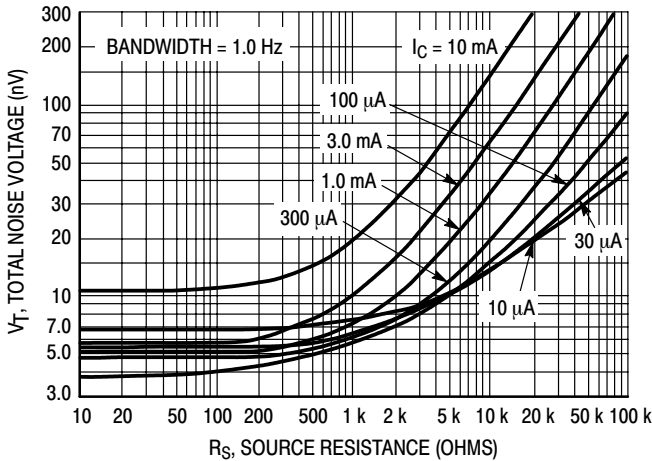

Figure 6. Total Noise Voltage

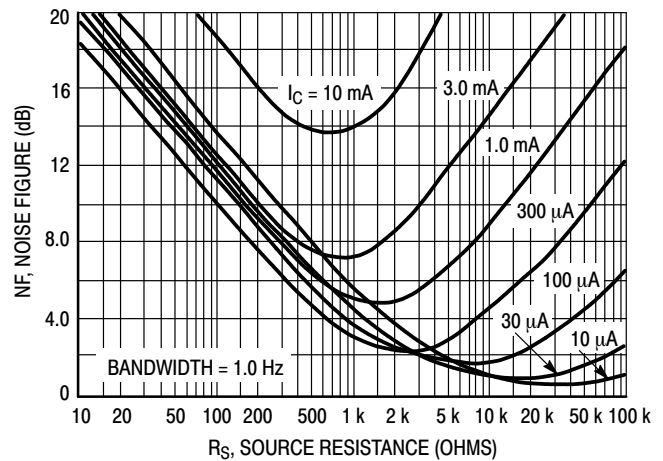

Figure 7. Noise Figure

MMBT6428LT1, MMBT6429LT1

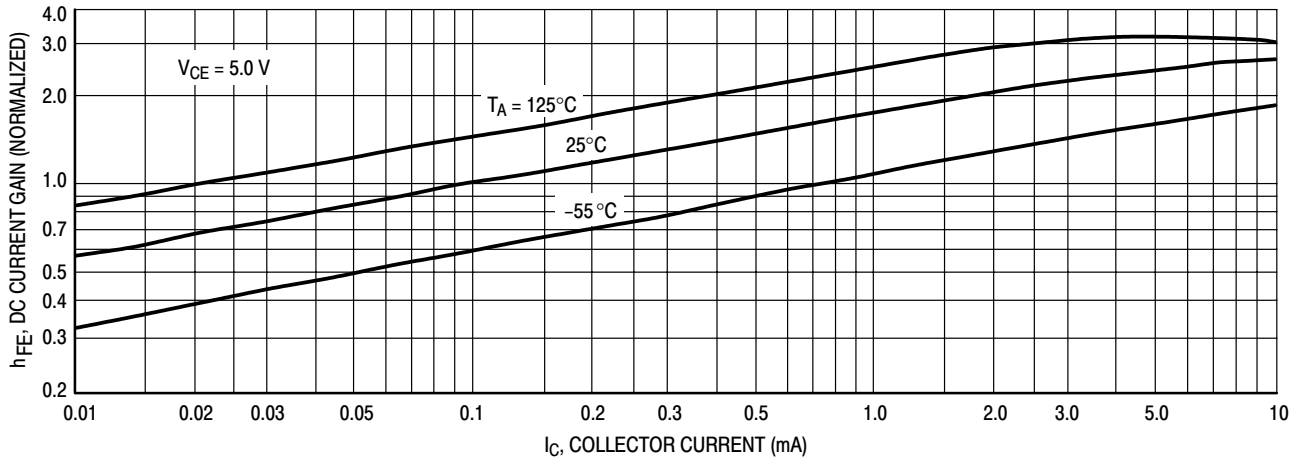

Figure 8. DC Current Gain

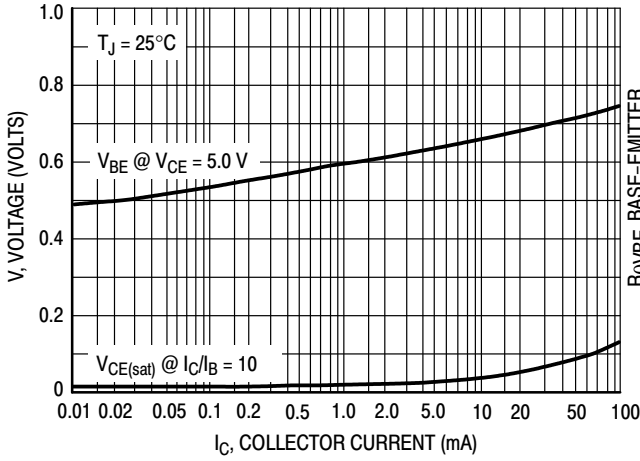

Figure 9. "On" Voltages

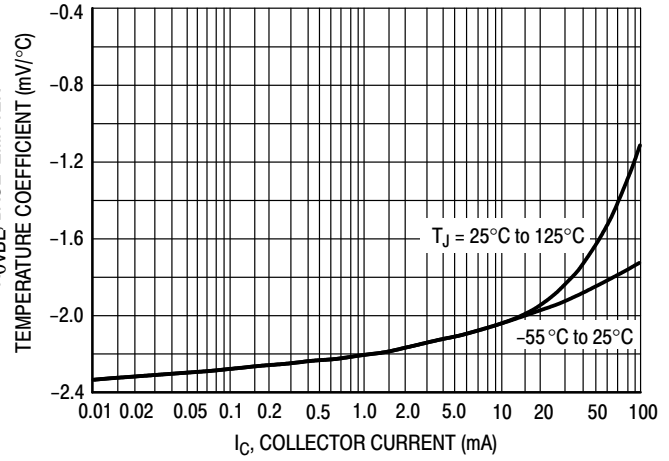

Figure 10. Temperature Coefficients

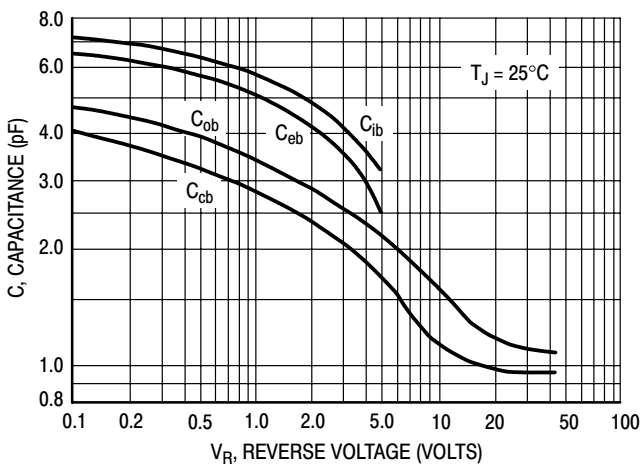

Figure 11. Capacitance

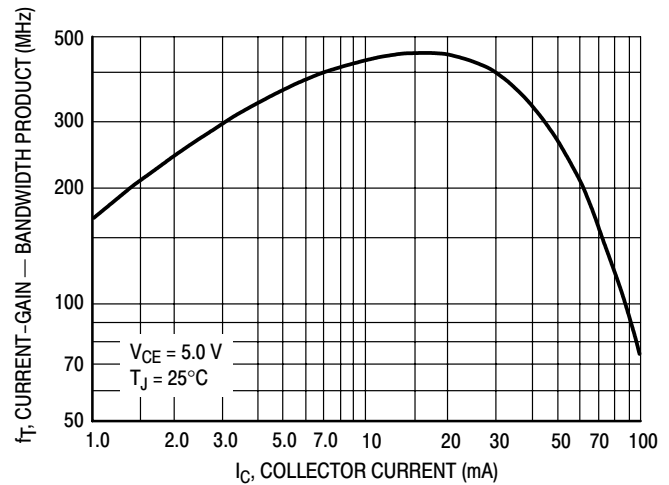
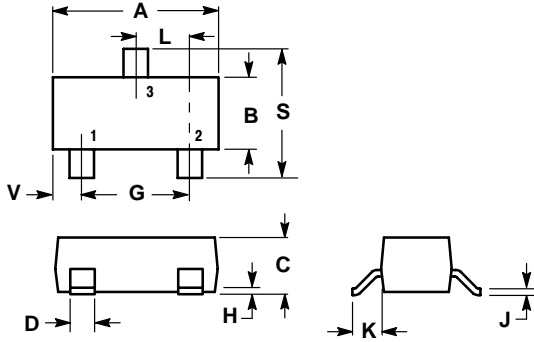

Figure 12. Current-Gain — Bandwidth Product

MMBT6428LT1, MMBT6429LT1

PACKAGE DIMENSIONS

SOT-23 (TO236)
CASE 318-18
ISSUE AK



- NOTES:
1. DIMENSIONING AND TOLERANCING PER ANSI Y14.5M, 1982.
 2. CONTROLLING DIMENSION: INCH.
 3. MAXIMUM LEAD THICKNESS INCLUDES LEAD FINISH THICKNESS. MINIMUM LEAD THICKNESS IS THE MINIMUM THICKNESS OF BASE MATERIAL.
 4. 318-01 THRU -07 AND -09 OBSOLETE, NEW STANDARD 318-08.

| DIM | INCHES | | MILLIMETERS | |
|-----|--------|--------|-------------|-------|
| | MIN | MAX | MIN | MAX |
| A | 0.1102 | 0.1197 | 2.80 | 3.04 |
| B | 0.0472 | 0.0551 | 1.20 | 1.40 |
| C | 0.0350 | 0.0440 | 0.89 | 1.11 |
| D | 0.0150 | 0.0200 | 0.37 | 0.50 |
| G | 0.0701 | 0.0807 | 1.78 | 2.04 |
| H | 0.0005 | 0.0040 | 0.013 | 0.100 |
| J | 0.0034 | 0.0070 | 0.085 | 0.177 |
| K | 0.0140 | 0.0285 | 0.35 | 0.69 |
| L | 0.0350 | 0.0401 | 0.89 | 1.02 |
| S | 0.0830 | 0.1039 | 2.10 | 2.64 |
| V | 0.0177 | 0.0236 | 0.45 | 0.60 |

STYLE 6:
PIN 1. BASE
2. EMITTER
3. COLLECTOR

SOLDERING FOOTPRINT*

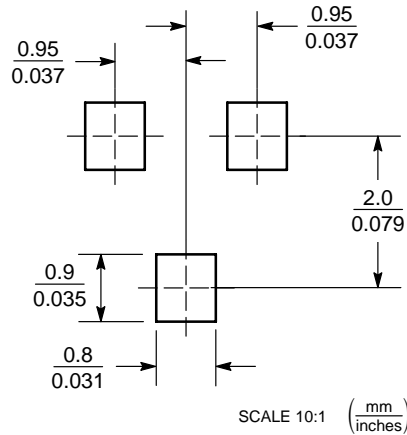

*For additional information on our Pb-Free strategy and soldering details, please download the ON Semiconductor Soldering and Mounting Techniques Reference Manual, SOLDERRM/D.

MMBT6428LT1, MMBT6429LT1

ON Semiconductor and  are registered trademarks of Semiconductor Components Industries, LLC (SCILLC). SCILLC reserves the right to make changes without further notice to any products herein. SCILLC makes no warranty, representation or guarantee regarding the suitability of its products for any particular purpose, nor does SCILLC assume any liability arising out of the application or use of any product or circuit, and specifically disclaims any and all liability, including without limitation special, consequential or incidental damages. "Typical" parameters which may be provided in SCILLC data sheets and/or specifications can and do vary in different applications and actual performance may vary over time. All operating parameters, including "Typicals" must be validated for each customer application by customer's technical experts. SCILLC does not convey any license under its patent rights nor the rights of others. SCILLC products are not designed, intended, or authorized for use as components in systems intended for surgical implant into the body, or other applications intended to support or sustain life, or for any other application in which the failure of the SCILLC product could create a situation where personal injury or death may occur. Should Buyer purchase or use SCILLC products for any such unintended or unauthorized application, Buyer shall indemnify and hold SCILLC and its officers, employees, subsidiaries, affiliates, and distributors harmless against all claims, costs, damages, and expenses, and reasonable attorney fees arising out of, directly or indirectly, any claim of personal injury or death associated with such unintended or unauthorized use, even if such claim alleges that SCILLC was negligent regarding the design or manufacture of the part. SCILLC is an Equal Opportunity/Affirmative Action Employer. This literature is subject to all applicable copyright laws and is not for resale in any manner.

PUBLICATION ORDERING INFORMATION

LITERATURE FULFILLMENT:

Literature Distribution Center for ON Semiconductor
P.O. Box 61312, Phoenix, Arizona 85082-1312 USA

Phone: 480-829-7710 or 800-344-3860 Toll Free USA/Canada

Fax: 480-829-7709 or 800-344-3867 Toll Free USA/Canada

Email: orderlit@onsemi.com

N. American Technical Support: 800-282-9855 Toll Free
USA/Canada

Japan: ON Semiconductor, Japan Customer Focus Center
2-9-1 Kamimeguro, Meguro-ku, Tokyo, Japan 153-0051
Phone: 81-3-5773-3850

ON Semiconductor Website: <http://onsemi.com>

Order Literature: <http://www.onsemi.com/litorder>

For additional information, please contact your
local Sales Representative.

MMBT6428LT1/D