

Description

These power driver arrays are an arrangement of either seven (2000 series) or eight (2800 series) darlington transistors with independent inputs and outputs. They are designed to provide high voltage, medium current interface between low voltage control logic and peripheral loads. The range of inputs available allow specific compatibility with all popular logic families (PMOS, CMOS, TTL, Shottky TTL). Different maximum output current / output voltage combinations allow the customer to select the device closest to the exact needs of the application. Each darlington is configured as an open collector output with internal flyback diode to protect against potentially destructive transient voltages caused by inductive loads.

Features

- 7 or 8 darlington power drives in single package
- 50V or 95V breakdown voltage ratings
- 500mA or 600mA output current capability per driver
- Low saturation voltage
- 5 input options to allow correct interface with all popular logic families
- Internal clamp diodes for driving inductive loads
- Improved cross-talk noise suppression
- Hermetically sealed package
- Operating temperature range; -55°C to $+125^{\circ}\text{C}$

Connections

DataSheet4U.com

DataSheet4U.com

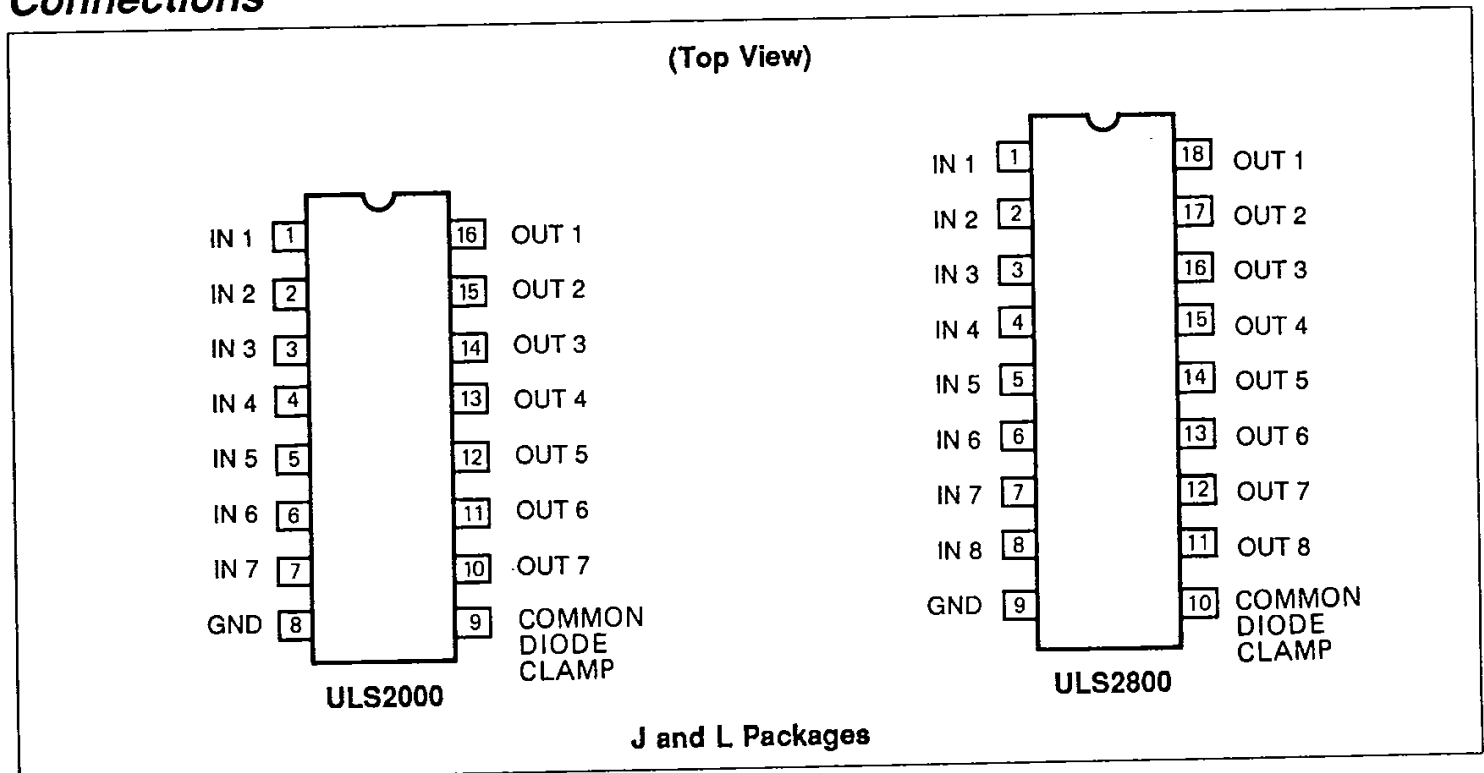

Absolute Maximum Ratings (T_A = 25°C)

Output Voltage, V_{CE}	
ULS2000, 2010, 2800, 2810 Series	50V
ULS2020, 2820 Series	95V
Input Voltage, V_{IN}	
ULS2002, 2003, 2004, 2802, 2803, 2804	30V
ULS2005, 2805	15V
Continuous Collector Current, I_C	
ULS2000, 2020, 2800, 2820 Series	500mA
ULS2010, 2810 Series	600mA

Ground Pin Current, I_{GND}	3.0A
Continuous Base Current, I_B	25mA
Power Dissipation, P_D	
(Single Darlington Drive)	1.0W
(Total Package Power Dissipation is Specified on Graphs of Collector Current Versus Duty Cycle)	
Operating Temp. Range, T_A	-55°C to +125°C
Storage Temp. Range, T_S	-65°C to +150°C

Absolute maximum ratings are those values beyond which the safety of the device cannot be guaranteed. They are not meant to imply that the device should be operated at these limits. The electrical characteristics provide conditions for actual device operation.

Schematic Diagrams (Single Darlington Shown)

ULS2001, 2011, 2021
ULS2801, 2811, 2821

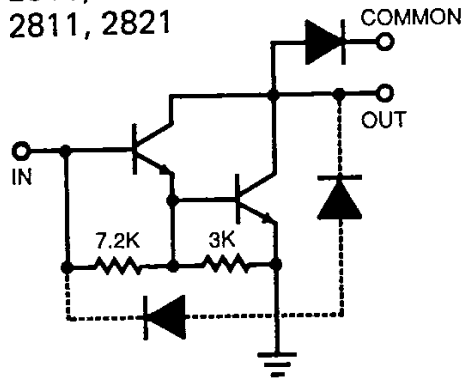

ULS2002, 2012, 2022
ULS2802, 2812, 2822

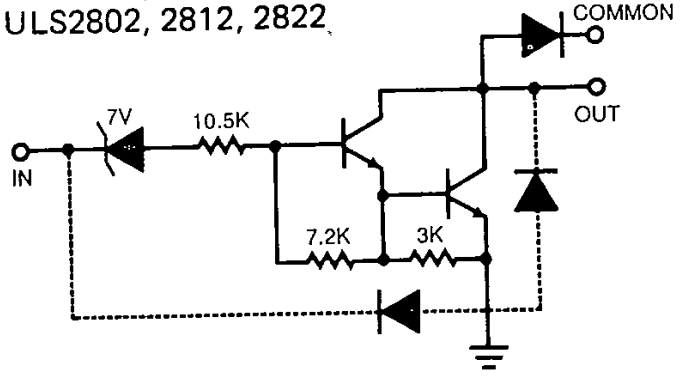

ULS2003, 2013, 2023
ULS2803, 2813, 2823

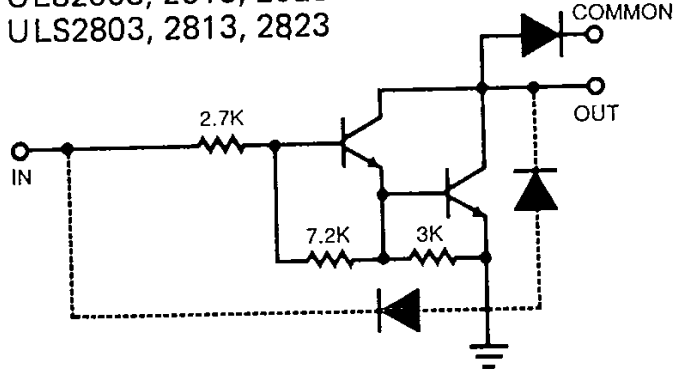

ULS2004, 2014, 2024
ULS2804, 2814, 2824

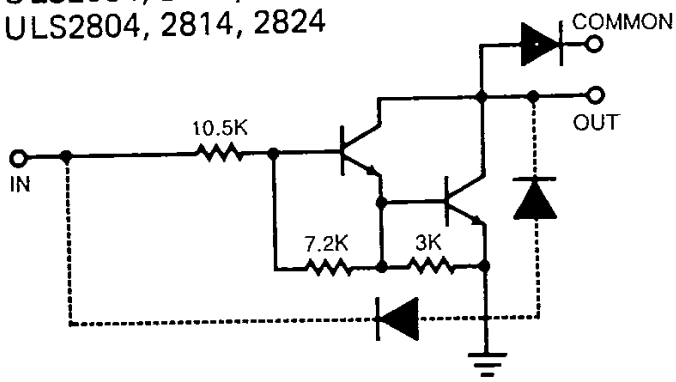

ULS2005, 2015, 2025
ULS2805, 2815, 2825

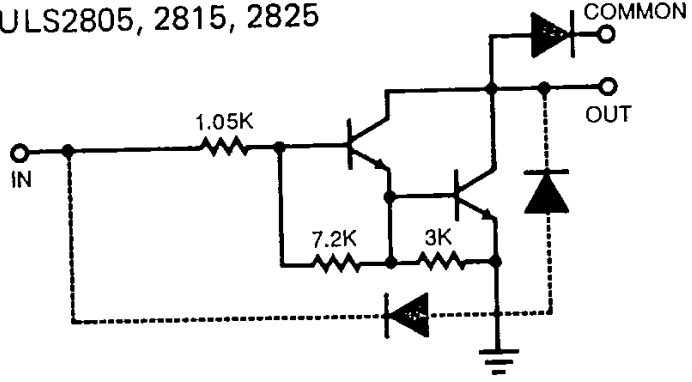

Electrical Characteristics

Characteristic	Conditions	Device	Temp	ULS2000/ULS2800			Units	
				Min	Typ	Max		
Output Leakage Current, I_{CEX}	$V_{CE} = 50V$	All	•			100	μA	
	$V_{CE} = 50V, V_{IN} = 6V$	2002, 2802	•			500	μA	
	$V_{CE} = 50V, V_{IN} = 1V$	2004, 2804	•			500	μA	
Collector-Emitter Saturation Voltage, $V_{CE(SAT)}$	$I_C = 350mA, I_B = 850\mu A$	All	-55°C		1.6	1.8	V	
	$I_C = 200mA, I_B = 550\mu A$		-55°C		1.3	1.5	V	
	$I_C = 100mA, I_B = 350\mu A$		-55°C		1.1	1.3	V	
	$I_C = 350mA, I_B = 500\mu A$				1.25	1.6	V	
	$I_C = 200mA, I_B = 350\mu A$				1.1	1.3	V	
	$I_C = 100mA, I_B = 250\mu A$				0.9	1.1	V	
	$I_C = 350mA, I_B = 500\mu A$		+125°C		1.6	1.8	V	
	$I_C = 200mA, I_B = 350\mu A$		+125°C		1.3	1.5	V	
	$I_C = 100mA, I_B = 250\mu A$		+125°C		1.1	1.3	V	
	Input Current, $I_{IN(ON)}$		$V_{IN} = 17V$	2002, 2802	•	480	850	1300
$V_{IN} = 3.85V$		2003, 2803	•	650	930	1350	μA	
$V_{IN} = 5V$		2004, 2804	•	240	350	500	μA	
$V_{IN} = 12V$			•	650	1000	1450	μA	
$V_{IN} = 3V$		2005, 2805	•	1180	1500	2400	μA	
Input Current, $I_{IN(OFF)}$	$I_C = 500\mu A$	All	+125°C	25	50		μA	
Input Voltage, $V_{IN(ON)}$	$V_{CE} = 2V, I_C = 300mA$	2002, 2802	-55°C			18	V	
	$V_{CE} = 2V, I_C = 300mA$		+125°C			13	V	
	$V_{CE} = 2V, I_C = 200mA$	2003, 2803	-55°C			3.3	V	
	$V_{CE} = 2V, I_C = 250mA$		-55°C			3.6	V	
	$V_{CE} = 2V, I_C = 300mA$		-55°C			3.9	V	
	$V_{CE} = 2V, I_C = 200mA$		+125°C			2.4	V	
	$V_{CE} = 2V, I_C = 250mA$		+125°C			2.7	V	
	$V_{CE} = 2V, I_C = 300mA$		+125°C			3.0	V	
	$V_{CE} = 2V, I_C = 125mA$	2004, 2804	-55°C			6.0	V	
	$V_{CE} = 2V, I_C = 200mA$		-55°C			8.0	V	
	$V_{CE} = 2V, I_C = 275mA$		-55°C			10	V	
	$V_{CE} = 2V, I_C = 350mA$		-55°C			12	V	
	$V_{CE} = 2V, I_C = 125mA$		+125°C			5.0	V	
	$V_{CE} = 2V, I_C = 200mA$		+125°C			6.0	V	
	$V_{CE} = 2V, I_C = 275mA$		+125°C			7.0	V	
	$V_{CE} = 2V, I_C = 350mA$		+125°C			8.0	V	
	$V_{CE} = 2V, I_C = 350mA$	2005, 2805	-55°C			3.0	V	
	$V_{CE} = 2V, I_C = 350mA$		+125°C			2.4	V	
	DC Forward Current	$V_{CE} = 2V, I_C = 350mA$	2001, 2801	-55°C	500			
		$V_{CE} = 2V, I_C = 350mA$			1000			
Transfer Ratio, h_{FE}		All			15	25	pF	
Input Capacitance, C_{IN}		All			250	1000	ns	
Turn-on Delay, t_{PLH}	$0.5 E_{IN}$ to $0.5 E_{OUT}$	All			250	1000	ns	
Turn-off Delay, t_{PHL}	$0.5 E_{IN}$ to $0.5 E_{OUT}$	All						
Clamp Diode Leakage Current, I_R	$V_R = 50V$	All	•			50	μA	
Clamp Diode Forward Voltage, V_F	$I_F = 350mA$	All	•		1.7	2.0	V	

The • denotes the specifications which apply over the full operating temperature range, all others apply at $T_A = 25^\circ C$ unless otherwise specified.

Characteristic	Conditions	Device	Temp	ULS2010/ULS2810			Units
				Min	Typ	Max	
Output Leakage Current, I_{CEX}	$V_{CE} = 50V$	All	•			100	μA
	$V_{CE} = 50V, V_{IN} = 6V$	2012, 2812	•			500	μA
	$V_{CE} = 50V, V_{IN} = 1V$	2014, 2814	•			500	μA
Collector-Emitter Saturation Voltage, $V_{CE(SAT)}$	$I_C = 500mA, I_B = 1100\mu A$	All	-55°C		1.8	2.1	V
	$I_C = 350mA, I_B = 850\mu A$		-55°C		1.6	1.8	V
	$I_C = 200mA, I_B = 550\mu A$		-55°C		1.3	1.5	V
	$I_C = 500mA, I_B = 600\mu A$				1.7	1.9	V
	$I_C = 350mA, I_B = 500\mu A$				1.25	1.6	V
	$I_C = 200mA, I_B = 350\mu A$				1.1	1.3	V
	$I_C = 500mA, I_B = 600\mu A$		+125°C		1.8	2.1	V
	$I_C = 350mA, I_B = 500\mu A$		+125°C		1.6	1.8	V
	$I_C = 200mA, I_B = 350\mu A$		+125°C		1.3	1.5	V
Input Current, $I_{IN(ON)}$	$V_{IN} = 17V$	2012, 2812	•	480	850	1300	μA
	$V_{IN} = 3.85V$	2013, 2813	•	650	930	1350	μA
	$V_{IN} = 5V$	2014, 2814	•	240	350	500	μA
	$V_{IN} = 12V$		•	650	1000	1450	μA
	$V_{IN} = 3V$	2015, 2815	•	1180	1500	2400	μA
Input Current, $I_{IN(OFF)}$	$I_C = 500\mu A$	All	+125°C	25	50		μA
Input Voltage, $V_{IN(ON)}$	$V_{CE} = 2V, I_C = 500mA$	2012, 2812	-55°C			23.5	V
	$V_{CE} = 2V, I_C = 500mA$		+125°C			17	V
	$V_{CE} = 2V, I_C = 250mA$	2013, 2813	-55°C			3.6	V
	$V_{CE} = 2V, I_C = 300mA$		-55°C			3.9	V
	$V_{CE} = 2V, I_C = 500mA$		-55°C			6.0	V
	$V_{CE} = 2V, I_C = 250mA$		+125°C			2.7	V
	$V_{CE} = 2V, I_C = 300mA$		+125°C			3.0	V
	$V_{CE} = 2V, I_C = 500mA$		+125°C			3.5	V
	$V_{CE} = 2V, I_C = 275mA$	2014, 2814	-55°C			10	V
	$V_{CE} = 2V, I_C = 350mA$		-55°C			12	V
	$V_{CE} = 2V, I_C = 500mA$		-55°C			17	V
	$V_{CE} = 2V, I_C = 275mA$		+125°C			7.0	V
	$V_{CE} = 2V, I_C = 350mA$		+125°C			8.0	V
	$V_{CE} = 2V, I_C = 500mA$		+125°C			9.5	V
	$V_{CE} = 2V, I_C = 350mA$	2015, 2815	-55°C			3.0	V
	$V_{CE} = 2V, I_C = 500mA$		-55°C			3.5	V
	$V_{CE} = 2V, I_C = 350mA$		+125°C			2.4	V
	$V_{CE} = 2V, I_C = 500mA$		+125°C			2.6	V
	DC Forward Current	$V_{CE} = 2V, I_C = 500mA$	2011, 2811	-55°C	450		
Transfer Ratio, h_{FE}	$V_{CE} = 2V, I_C = 500mA$			900			
Input Capacitance, C_{IN}		All			15	25	pF
Turn-on Delay, t_{PLH}	0.5 E_{IN} to 0.5 E_{OUT}	All			250	1000	ns
Turn-off Delay, t_{PHL}	0.5 E_{IN} to 0.5 E_{OUT}	All			250	1000	ns
Clamp Diode Leakage Current, I_R	$V_R = 50V$	All	•			50	μA
Clamp Diode Forward Voltage, V_F	$I_F = 350mA$	All	•		1.7	2.0	V
	$I_F = 500mA$		•			2.5	V

Electrical Characteristics Continued

Characteristic	Conditions	Device	Temp	ULS2020 / ULS2820			Units	
				Min	Typ	Max		
Output Leakage Current, I_{CEX}	$V_{CE} = 95V$	All	•			100	μA	
	$V_{CE} = 95V, V_{IN} = 6V$	2022, 2822	•			500	μA	
	$V_{CE} = 95V, V_{IN} = 1V$	2024, 2824	•			500	μA	
Collector-Emitter Saturation Voltage, $V_{CE(SAT)}$	$I_C = 350mA, I_B = 850\mu A$	All	-55°C		1.6	1.8	V	
	$I_C = 200mA, I_B = 550\mu A$		-55°C		1.3	1.5	V	
	$I_C = 100mA, I_B = 350\mu A$		-55°C		1.1	1.3	V	
	$I_C = 350mA, I_B = 500\mu A$				1.25	1.6	V	
	$I_C = 200mA, I_B = 350\mu A$				1.1	1.3	V	
	$I_C = 100mA, I_B = 250\mu A$				0.9	1.1	V	
	$I_C = 350mA, I_B = 500\mu A$		+125°C		1.6	1.8	V	
	$I_C = 200mA, I_B = 350\mu A$		+125°C		1.3	1.5	V	
	$I_C = 100mA, I_B = 250\mu A$		+125°C		1.1	1.3	V	
	Input Current, $I_{IN(ON)}$		$V_{IN} = 17V$	2022, 2822	•	480	850	1300
$V_{IN} = 3.85V$		2023, 2823	•	650	930	1350	μA	
$V_{IN} = 5V$		2024, 2824	•	240	350	500	μA	
$V_{IN} = 12V$			•	650	1000	1450	μA	
$V_{IN} = 3V$		2025, 2825	•	1180	1500	2400	μA	
Input Current, $I_{IN(OFF)}$	$I_C = 500\mu A$	All	+125°C	25	50		μA	
Input Voltage, $V_{IN(ON)}$	$V_{CE} = 2V, I_C = 300mA$	2022, 2822	-55°C			18	V	
	$V_{CE} = 2V, I_C = 300mA$		+125°C			13	V	
	$V_{CE} = 2V, I_C = 200mA$	2023, 2823	-55°C			3.3	V	
	$V_{CE} = 2V, I_C = 250mA$		-55°C			3.6	V	
	$V_{CE} = 2V, I_C = 300mA$		-55°C			3.9	V	
	$V_{CE} = 2V, I_C = 200mA$		+125°C			2.4	V	
	$V_{CE} = 2V, I_C = 250mA$		+125°C			2.7	V	
	$V_{CE} = 2V, I_C = 300mA$		+125°C			3.0	V	
	$V_{CE} = 2V, I_C = 125mA$	2024, 2824	-55°C			6.0	V	
	$V_{CE} = 2V, I_C = 200mA$		-55°C			8.0	V	
	$V_{CE} = 2V, I_C = 275mA$		-55°C			10	V	
	$V_{CE} = 2V, I_C = 350mA$		-55°C			12	V	
	$V_{CE} = 2V, I_C = 125mA$		+125°C			5.0	V	
	$V_{CE} = 2V, I_C = 200mA$		+125°C			6.0	V	
	$V_{CE} = 2V, I_C = 275mA$		+125°C			7.0	V	
	$V_{CE} = 2V, I_C = 350mA$		+125°C			8.0	V	
	$V_{CE} = 2V, I_C = 350mA$	2025, 2825	-55°C			3.0	V	
	$V_{CE} = 2V, I_C = 350mA$		+125°C			2.4	V	
	DC Forward Current	$V_{CE} = 2V, I_C = 350mA$	2021, 2821	-55°C	500			
	Transfer Ratio, h_{FE}	$V_{CE} = 2V, I_C = 350mA$				1000		
Input Capacitance, C_{IN}		All			15	25	pF	
Turn-on Delay, t_{PLH}	$0.5 E_{IN}$ to $0.5 E_{OUT}$	All			250	1000	ns	
Turn-off Delay, t_{PHL}	$0.5 E_{IN}$ to $0.5 E_{OUT}$	All			250	1000	ns	
Clamp Diode Leakage Current, I_R	$V_R = 95V$	All	•			50	μA	
Clamp Diode Forward Voltage, V_F	$I_F = 350mA$	All	•		1.7	2.0	V	

The • denotes the specifications which apply over the full operating temperature range, all others apply at $T_A = 25^\circ C$ unless otherwise specified.

Operating Conditions

1-43-03

ULS2000L — Peak Collector Current as a Function of Duty Cycle (See Note)

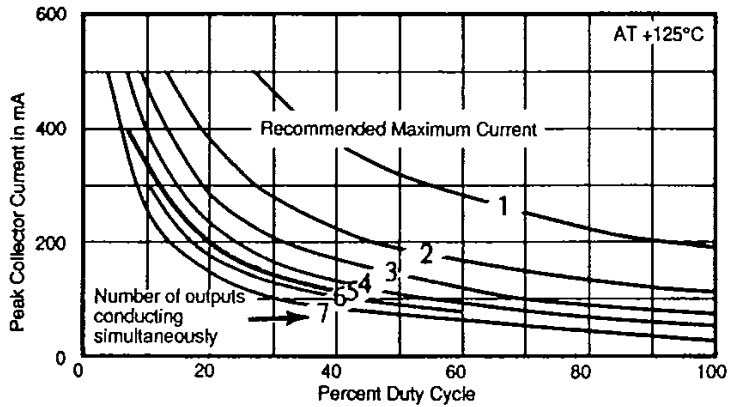
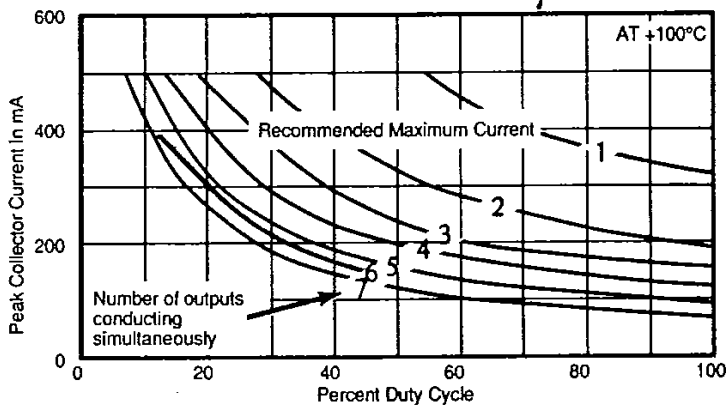
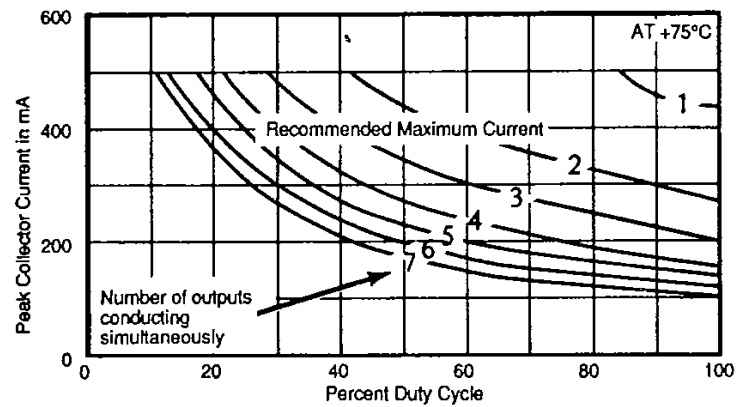
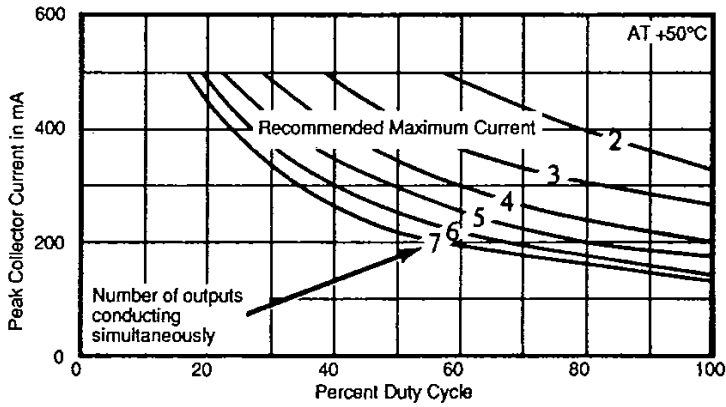

ULS2000J — Peak Collector Current as a Function of Duty Cycle (See Note)

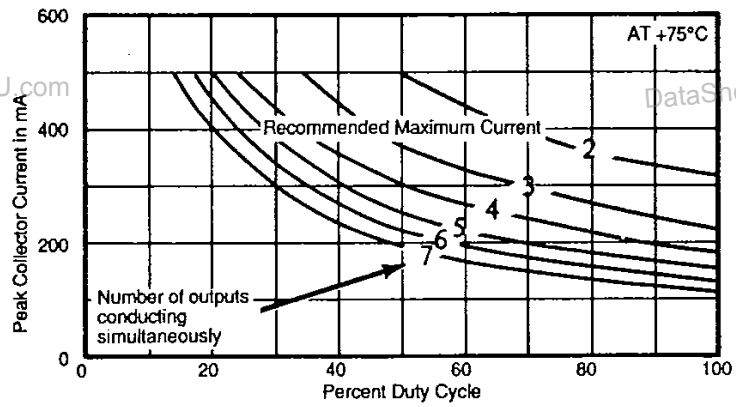
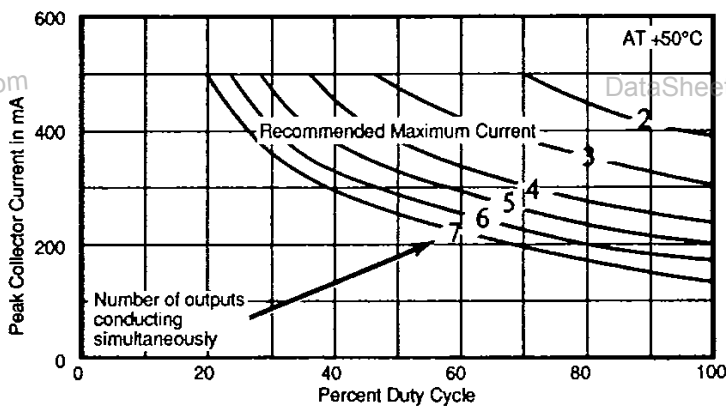

ULS2800J — Peak Collector Current as a Function of Duty Cycle (See Note)

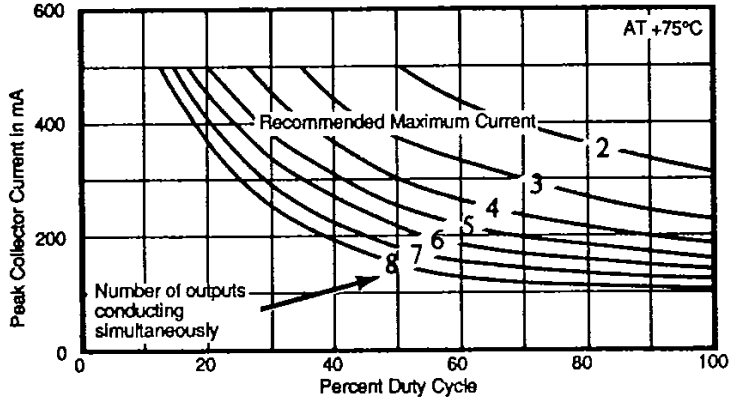
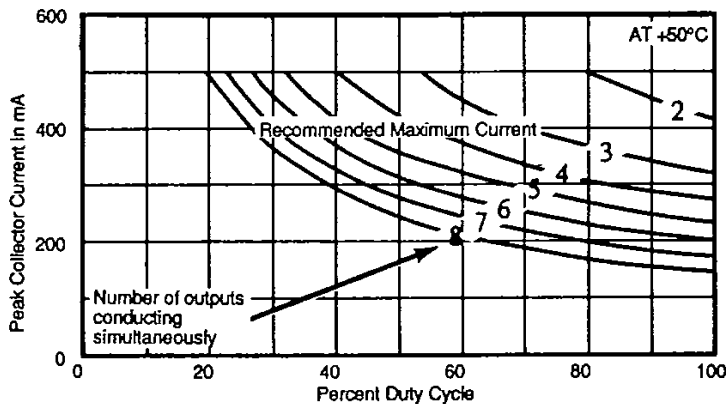

Note: The recommended maximum currents apply to the 2000, 2800, 2020, and 2820 series.

ULS2800L — Peak Collector Current as a Function of Duty Cycle (See Note)

T-43-

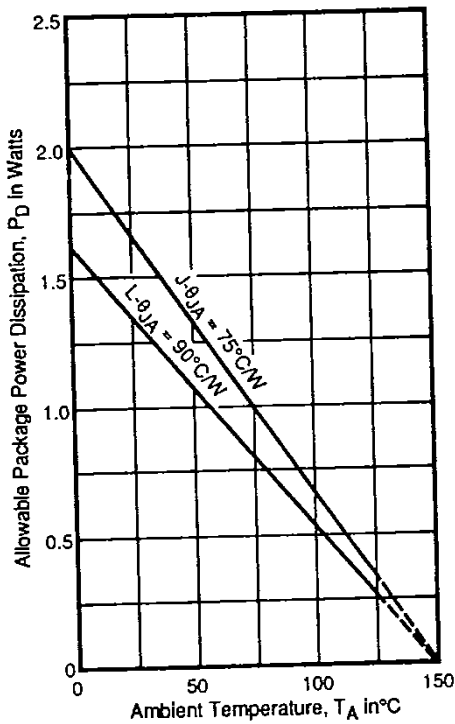
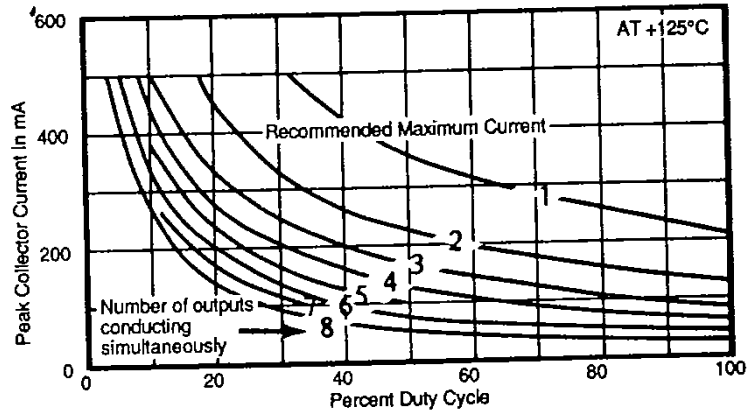
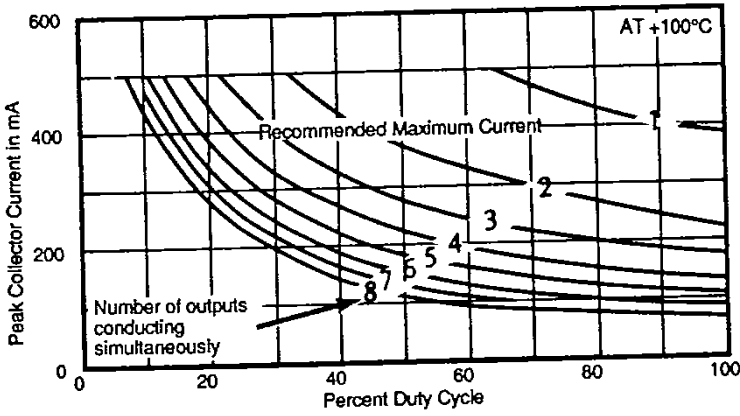
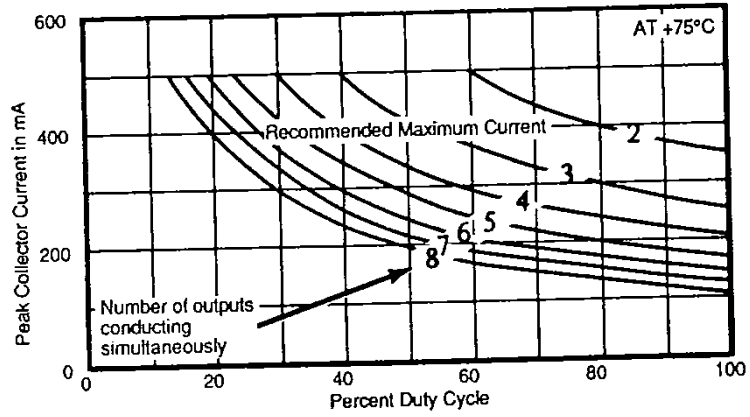
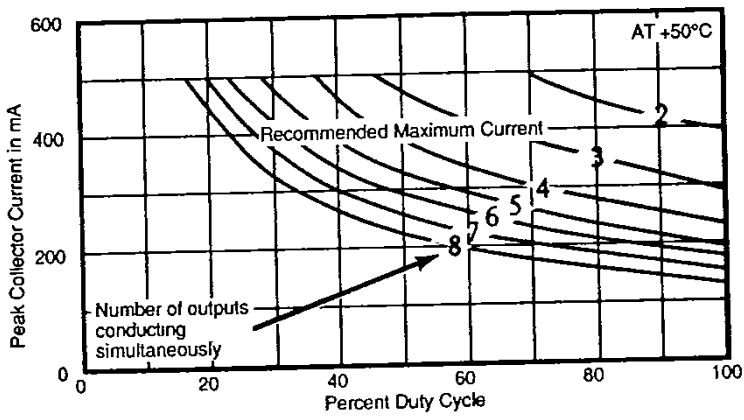

Allowable Package Power Dissipation
ULS-2000J and ULS-2000L

DataSheet4U.com

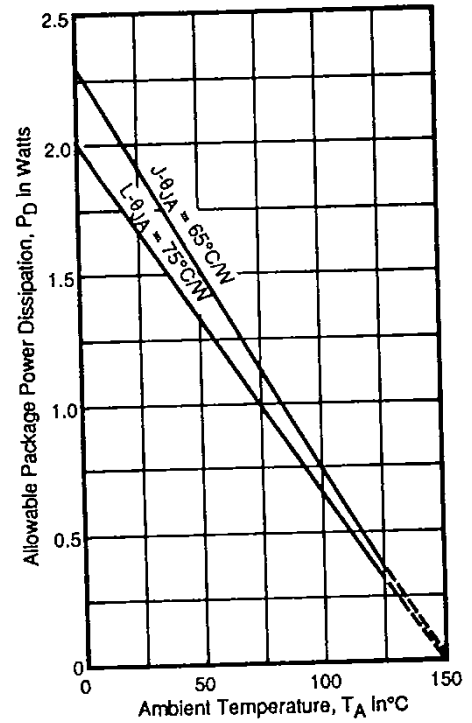

Allowable Package Power Dissipation
ULS-2800J and ULS-2800L

DataSheet4U.com

Note: The recommended maximum currents apply to 2000, 2800, 2020, and 2820 series.

Saturation Voltage Characteristics

1-73-23

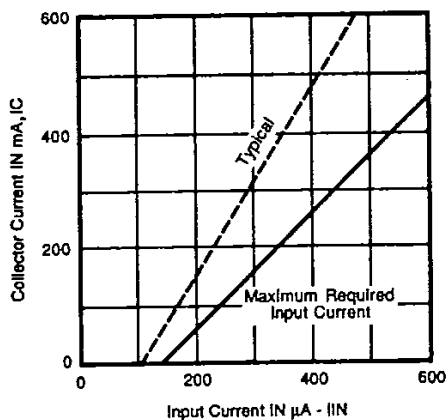

Collector Current as a Function of Input Current

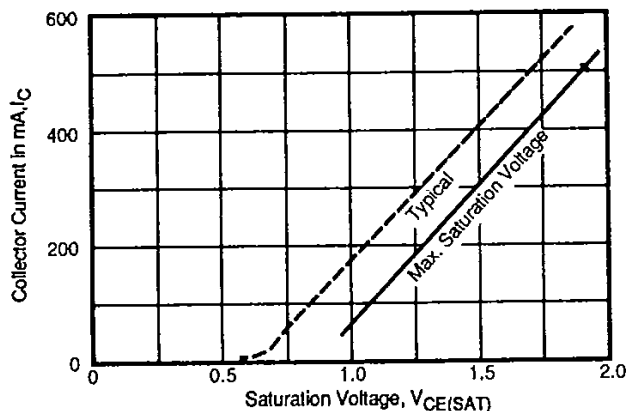

Collector Current as a Function of Saturation Voltage

Order Information

Input Conditions	Maximum Output Conditions					
	7 Segment Drive			8 Segment Drive		
	V _{CE} = 50V I _C = 500mA	V _{CE} = 50V I _C = 600mA	V _{CE} = 95V I _C = 500mA	V _{CE} = 50V I _C = 500mA	V _{CE} = 50V I _C = 600mA	V _{CE} = 95V I _C = 500mA
General Purpose CMOS, PMOS	ULS2001J ULS2001L	ULS2011J ULS2011L	ULS2021J ULS2021L	ULS2801J ULS2801L	ULS2811J ULS2811L	ULS2821J ULS2821L
14 - 25V PMOS	ULS2002J ULS2002L	ULS2012J ULS2012L	ULS2022J ULS2022L	ULS2802J ULS2802L	ULS2812J ULS2812L	ULS2822J ULS2822L
5V TTL, CMOS	ULS2003J ULS2003L	ULS2013J ULS2013L	ULS2023J ULS2023L	ULS2803J ULS2803L	ULS2813J ULS2813L	ULS2823J ULS2823L
6 - 15V CMOS, PMOS	ULS2004J ULS2004L	ULS2014J ULS2014L	ULS2024J ULS2024L	ULS2804J ULS2804L	ULS2814J ULS2814L	ULS2824J ULS2824L
High Output TTL	ULS2005J ULS2005L	ULS2015J ULS2015L	ULS2025J ULS2025L	ULS2805J ULS2805L	ULS2815J ULS2815L	ULS2825J ULS2825L

Note: J — 16 or 18 pin Cerdip
L — 16 or 18 pin side braised ceramic

Integrated Power Semiconductors, Ltd. cannot assume responsibility for use of any circuitry other than circuitry entirely embodied in an Integrated Power product. No circuit patent licenses are implied. Integrated Power reserves the right to change the circuitry and specifications without notice at any time.

Integrated Power Semiconductors, Ltd.

2727 Wash Avenue, Suite 201, Santa Clara, CA 95051 • Telephone: 408-727-2772 • Telex: 350073 (IPS SNTA) • FAX: 408-988-6185
 8 Quaker Drive, West Warwick, RI 02893 • Telephone: 401-821-4260 • Telex: 332948 (IPS RI) • FAX: 401-823-7260
 2081 Business Center Drive, Suite 140, Irvine, CA 92715 • Telephone: 714-752-0188 • FAX: 714-752-5019
 789 Turnpike Street, North Andover, MA 01845 • Telephone: 617-683-9042 • FAX: 617-975-0193