

**RF Driver Amplifier
250 - 4000 MHz**

**MAAMSS0049
V1**

Features

- Output Intercept Point of +40 dBm over a 20 dB Input Power Range
- Broadband Operation
- Excellent ACPR performance
- Lead-Free SOT-89 Package
- 100% Matte Tin Plating over Copper
- Halogen-Free "Green" Mold Compound
- RoHS* Compliant and 260°C Reflow Compatible

Description

M/A-COM's MAAMSS0049 RF driver amplifier is a GaAs MMIC which exhibits exceptional linearity performance over a >20 dB dynamic range, as well as featuring high gain in a lead-free miniature SOT-89 surface mount plastic package. The device runs off a single +5 volt supply and draws 230 mA typically.

The MAAMSS0049 is fabricated using an HBT process to realize low current and high linearity. The process features full passivation for increased performance and reliability.

Functional Schematic

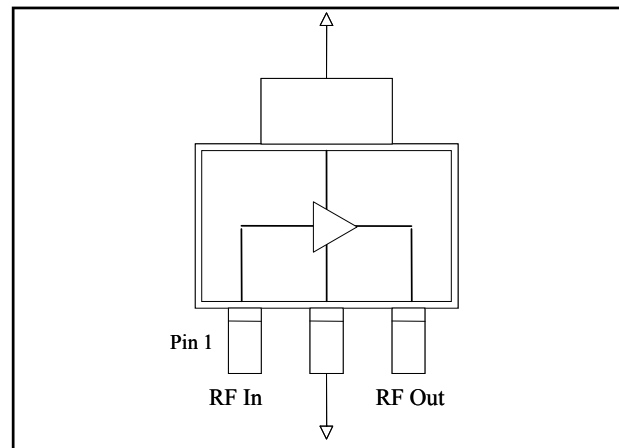

Pin Configuration

| Pin No. | Function | Pin No. | Function |
|---------|----------|---------|--------------------|
| 1 | RF Input | 3 | RF Output/ Bias |
| 2 | Ground | | |

Ordering Information ¹

| Part Number | Package |
|-------------------|------------------------|
| MAAMSS0049 | Bulk Packaging |
| MAAMSS0049SMB-01 | 900 MHz Configuration |
| MAAMSS0049SMB-02 | 1900 MHz Configuration |
| MAAMSS0049SMB-03 | 2140 MHz Configuration |
| MAAMSS0049TR-3000 | 3000 piece reel |

1. Reference Application Note M513 for reel size information.

Maximum Operating Conditions ²

| Parameter | Maximum Operating Conditions |
|----------------------|------------------------------|
| Junction Temperature | 160°C |
| RF Output Power | 28 dBm |

2. Operating at, or below this condition, at or below 85°C will give a MTTF > 1 x 10⁶ hours.

Absolute Maximum Ratings ^{3,4}

| Parameter | Absolute Maximum |
|-----------------------------------|-------------------|
| RF Output Power | 29 dBm |
| Voltage | 6 volts |
| Operating Temperature | -40 °C to +85 °C |
| Storage Temperature | -65 °C to +150 °C |
| Junction Temperature ⁵ | 200°C |

3. Exceeding any one or combination of these limits may cause permanent damage to this device.
4. M/A-COM does not recommend sustained operation near these survivability limits.
5. Typical thermal resistance (θ_{jc}) = 55°C/W.

* Restrictions on Hazardous Substances, European Union Directive 2002/95/EC.

**RF Driver Amplifier
250 - 4000 MHz**

**MAAMSS0049
V1**

Electrical Specifications: $T_A = 25^\circ\text{C}$, $V_{CC} = 5\text{ V}$, $Z_0 = 50\ \Omega$

| Parameter | Test Conditions | Units | Min. | Typ. | Max. |
|-------------------------|---|-------|------|------|------|
| Gain | 900 MHz | dB | — | 19.0 | — |
| | 1900 MHz | dB | — | 15.5 | — |
| | 2140 MHz | dB | 14 | 15.5 | — |
| Input Return Loss | 900 MHz | dB | — | -15 | — |
| | 1900 MHz | dB | — | -11 | — |
| | 2140 MHz | dB | — | -20 | — |
| Output Return Loss | 900 MHz | dB | — | -15 | — |
| | 1900 MHz | dB | — | -10 | — |
| | 2140 MHz | dB | — | -15 | — |
| Output P1dB | 900 MHz | dBm | — | 28.5 | — |
| | 1900 MHz | dBm | — | 28.5 | — |
| | 2140 MHz | dBm | — | 28.5 | — |
| Output IP3 | (+20 dBm / tone, 1 MHz spacing) 900 MHz | dBm | — | 43 | — |
| | 1900 MHz | dBm | — | 43 | — |
| | 2140 MHz | dBm | 38 | 43 | — |
| Channel Power | (@ -45 dBc ACPR, IS-95 9 channels fwd) 900 MHz | dBm | — | 22 | — |
| | 1900 MHz | dBm | — | 20 | — |
| | 2140 MHz | dBm | — | 19 | — |
| Noise Figure | 900 MHz | dB | — | 3.5 | — |
| | 1900 MHz | dB | — | 3.5 | — |
| | 2140 MHz | dB | — | 3.5 | — |
| Device / Supply Voltage | 900 MHz | V | — | 5 | — |
| | 1900 MHz | V | — | 5 | — |
| | 2140 MHz | V | — | 5 | — |
| Quiescent Current | | mA | — | 230 | — |
| Current @ 20 dBm Output | 2140 MHz | mA | — | 288 | 325 |

Lead-Free SOT-89 Plastic Package[†]

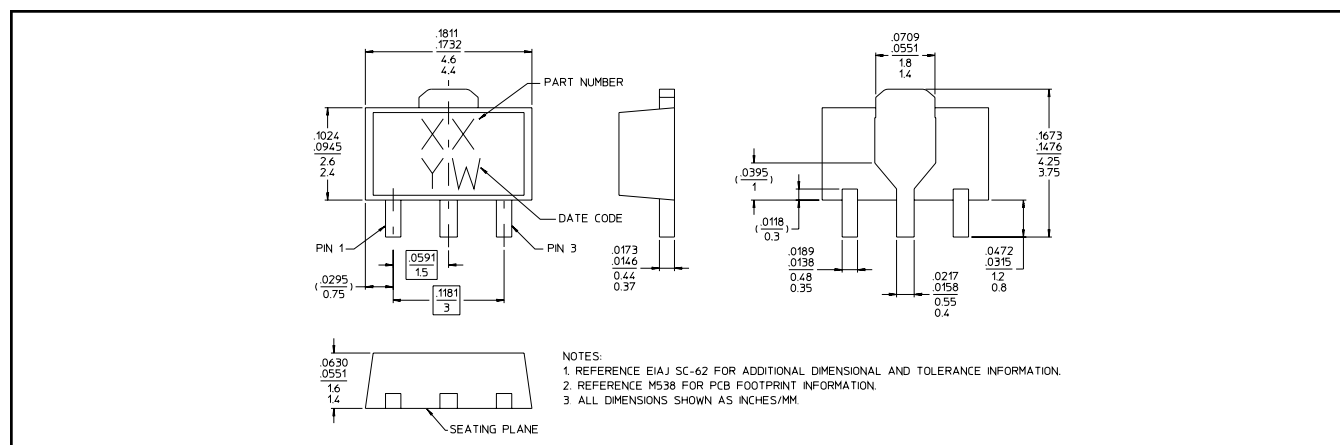

[†] Reference Application Note M538 for lead-free solder reflow recommendations.

**RF Driver Amplifier
250 - 4000 MHz**

**MAAMSS0049
V1**

900 MHz PCB Layout

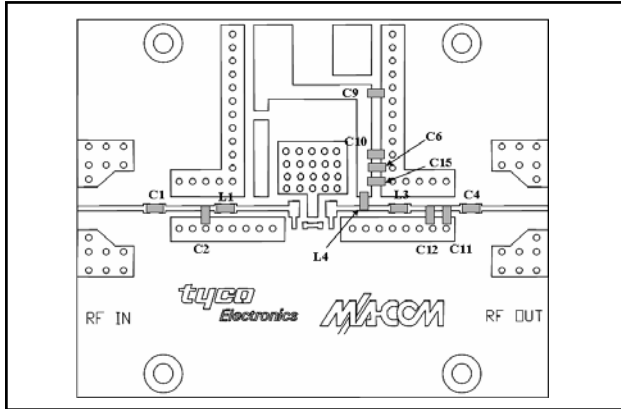

900 MHz Schematic

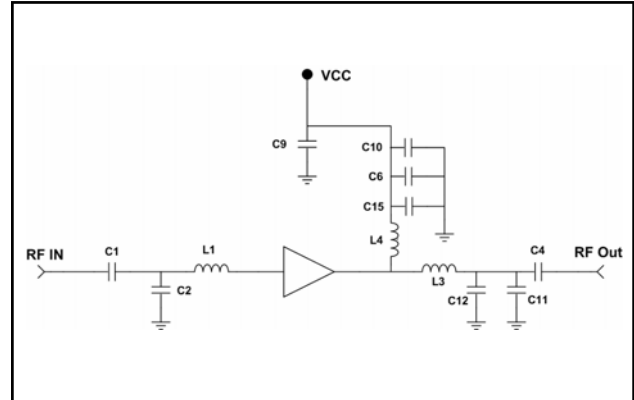

1900 MHz PCB Layout

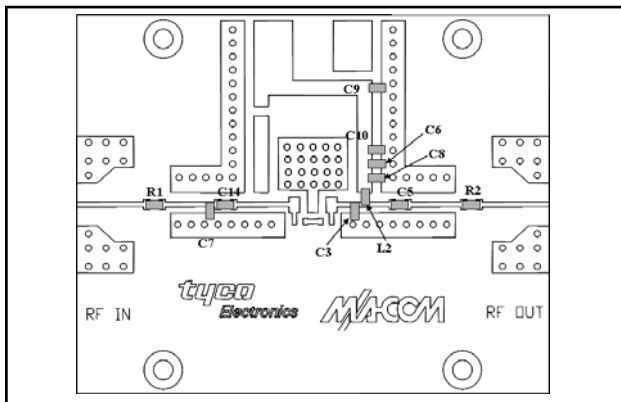

1900 MHz Schematic

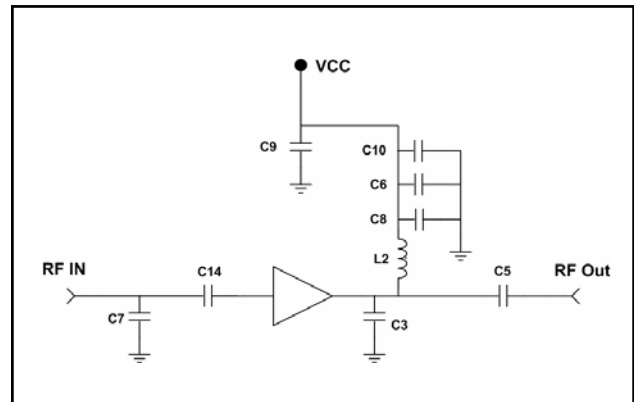

2140 MHz PCB Layout

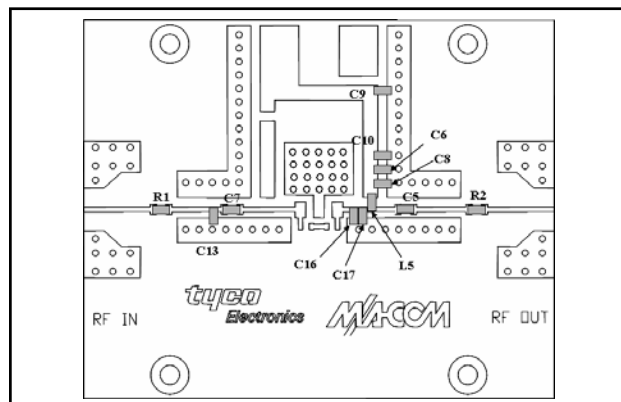

2140 Schematic

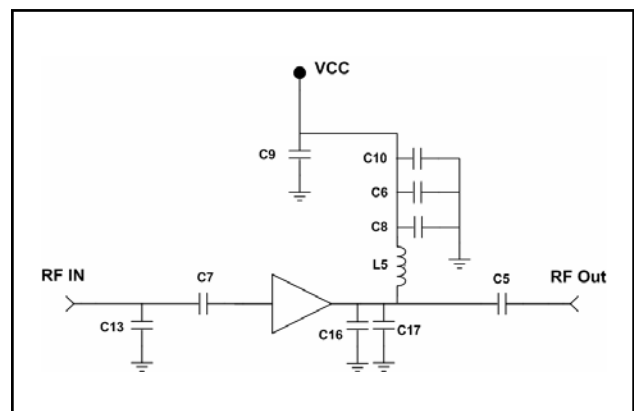

Parts List

| Part | Value | Used on Freq. Band | Case Style | Manufacturer | Purpose |
|---------------|---------|-----------------------------|------------|--------------|------------------------------|
| C1, C4 | 1000 pF | 300, 900 | 0402 | Murata | DC Block |
| C6 | 1000 pF | All | 0402 | Murata | Bypass |
| C2 | 6.8 pF | 900 | 0402 | Murata | Input Tuning |
| C3 | 3.3 pF | 1900 | 0402 | Murata | Output Tuning |
| C5 | 39 pF | 1900, 2140 | 0402 | Murata | DC Block |
| C7 | 2.7 pF | 1900, 2140 | 0402 | Murata | Input Tuning & DC Block |
| C8 | 15 pF | 300, 1900, 2140, 2400, 3500 | 0402 | Murata | Bypass |
| C9, C10 | 0.1 uF | All | 0402 | Murata | Bypass |
| C11 | 4.7 pF | 900 | 0402 | Murata | Output Tuning |
| C12 | 1.2 pF | 900 | 0402 | Murata | Output Tuning |
| C13 | 2.2 pF | 1900 | 0402 | Murata | Input Tuning |
| C16, C21 | 2.2 pF | 2140, 2400 | 0402 | Murata | Output Tuning |
| C14 | 5 pF | 1900 | 0402 | Murata | Output Tuning & DC Block |
| C15 | 100 pF | 900 | 0402 | Murata | Bypass |
| C17, C20, C23 | 1 pF | 2140, 2400, 3500 | 0402 | Murata | Input Tuning & Output Tuning |
| L1, L8 | 2.2 nH | 900, 2400 | 0402 | Coilcraft | Input Tuning |
| L2 | 5.6 nH | 1900 | 0402 | Coilcraft | Bias Injection |
| L3 | 1 nH | 900 | 0402 | Coilcraft | Output Tuning |
| L4 | 15 nH | 900 | 0402 | Coilcraft | Bias Injection |
| L5 | 3.6 nH | 2140 | 0402 | Coilcraft | Bias Injection |
| R1, R2 | 0 Ohms | 1900, 2140 | 0402 | Panasonic | Jumper |
| C18, C19 | 18 pF | 300 | 0402 | Murata | Input Tuning & Output Tuning |
| C22 | 0.5 pF | 2400, 3500 | 0402 | Murata | Input Tuning & Output Tuning |
| L6 | 23 nH | 300 | 0402 | Panasonic | Input Tuning |
| L7 | 8.2 nH | 300 | 0402 | Coilcraft | Output Tuning |

Cross Section View

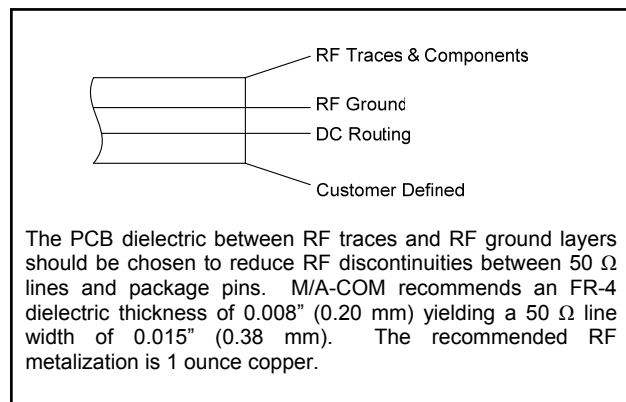

Handling Procedures

Please observe the following precautions to avoid damage:

Static Sensitivity

Gallium Arsenide Integrated Circuits are sensitive to electrostatic discharge (ESD) and can be damaged by static electricity. Proper ESD control techniques should be used when handling these devices.

Typical Performance Curves, 900 MHz Configuration, $V_{CC} = +5 V$

Gain

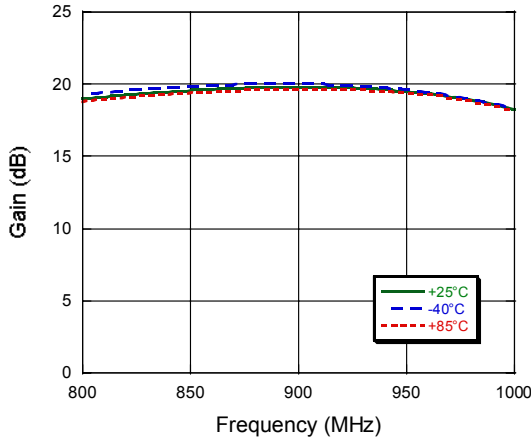

Noise Figure

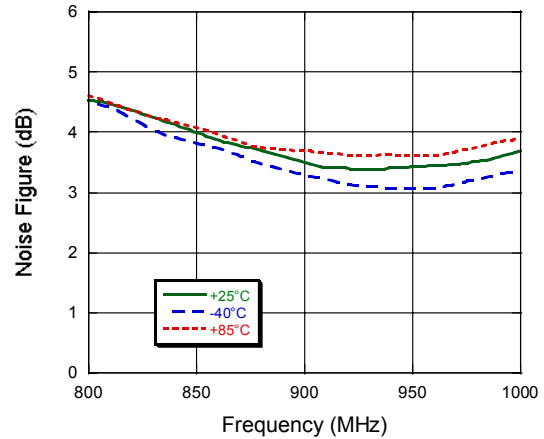

Input Return Loss

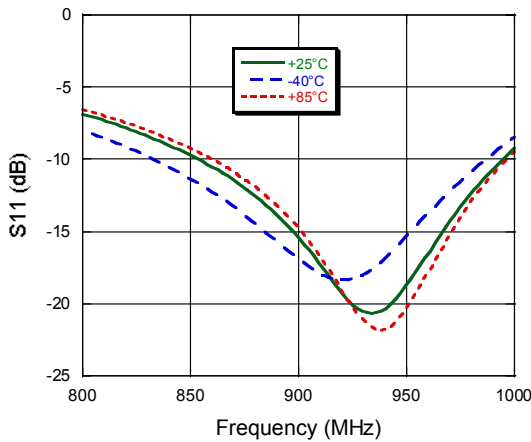

Output Return Loss

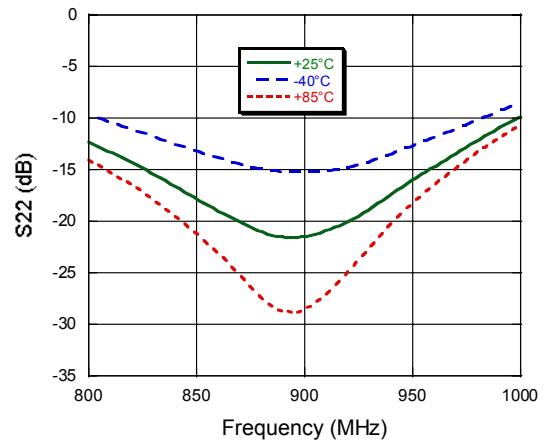

P1dB

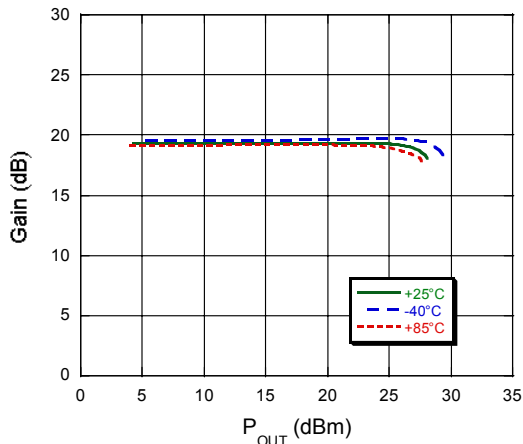

Output IP3

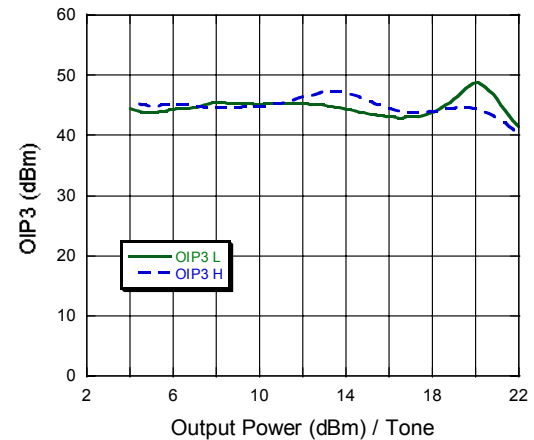

Typical Performance Curves, 1900 MHz Configuration

Gain

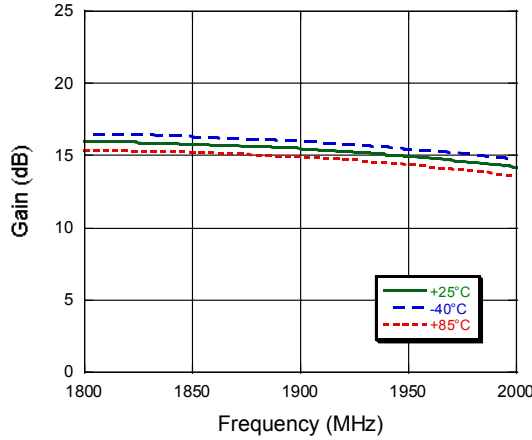

Noise Figure

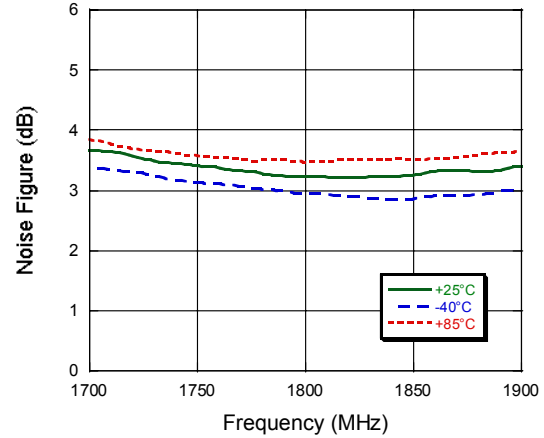

Input Return Loss

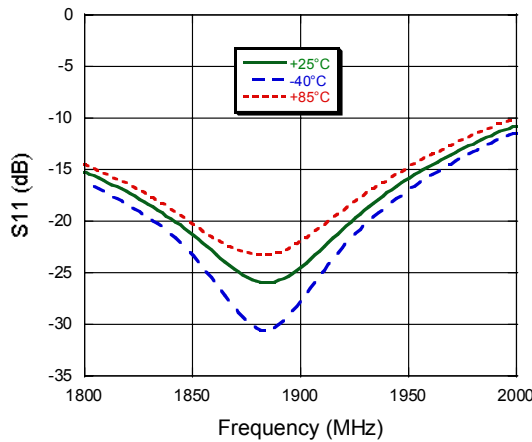

Output Return Loss

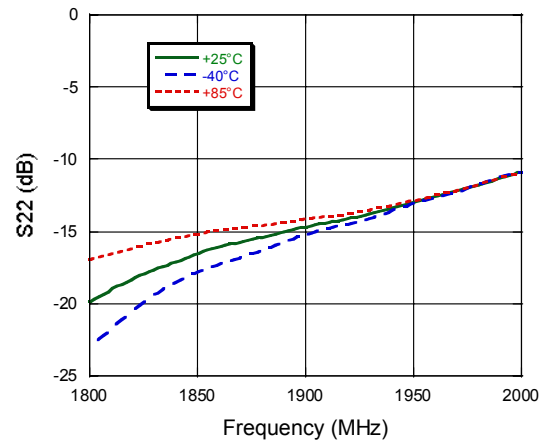

P1dB

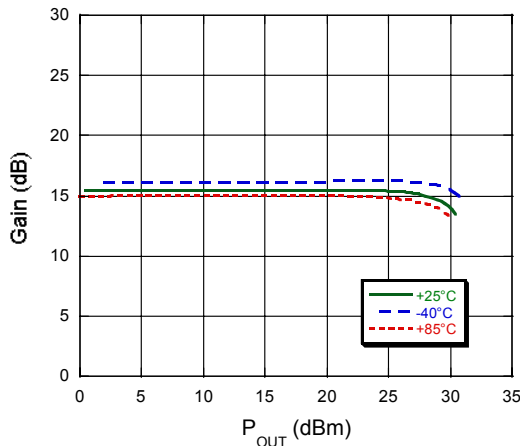

Output IP3

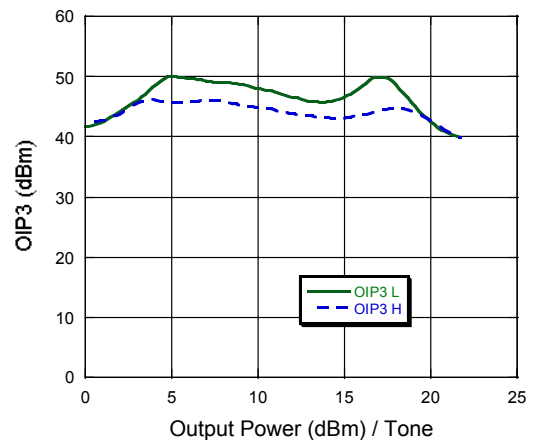

Typical Performance Curves, 2140 MHz Configuration

Gain

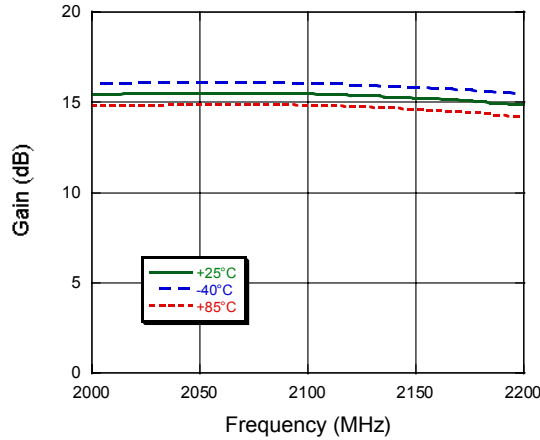

Noise Figure

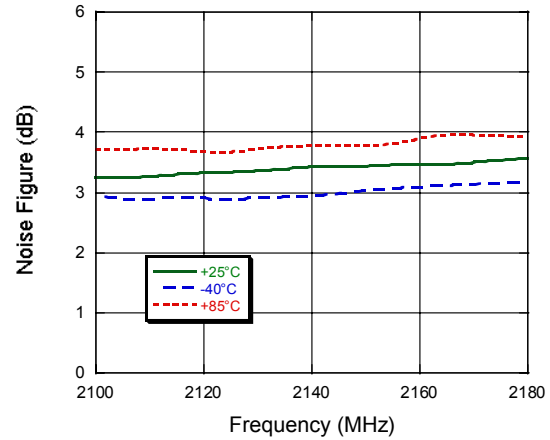

Input Return Loss

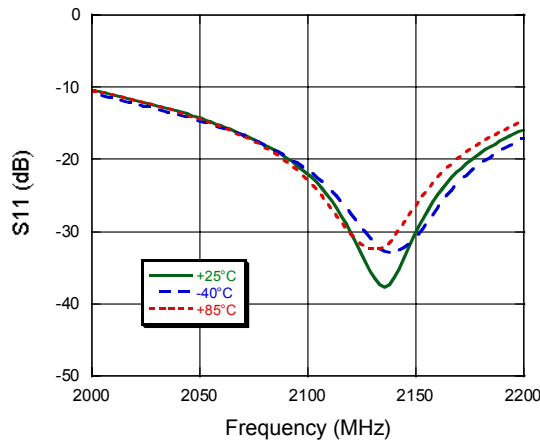

Output Return Loss

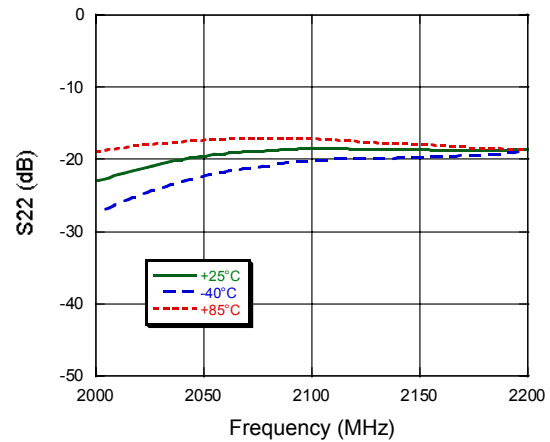

P1dB

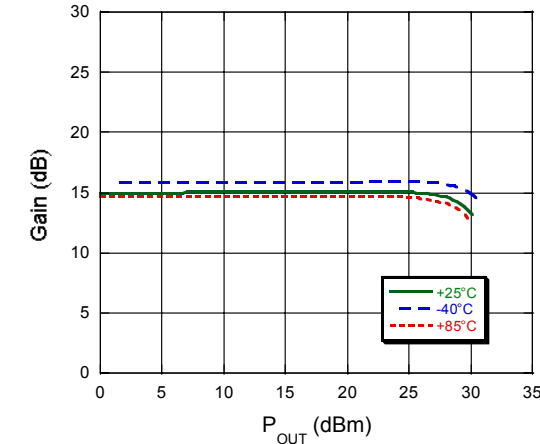

Output IP3

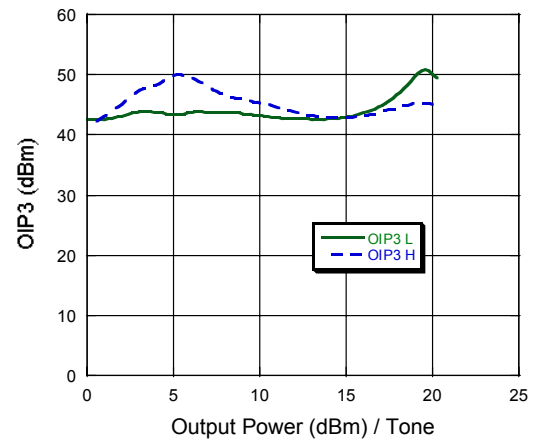

Applications Section

Typical Performance Curves, 300 MHz Configuration

Gain

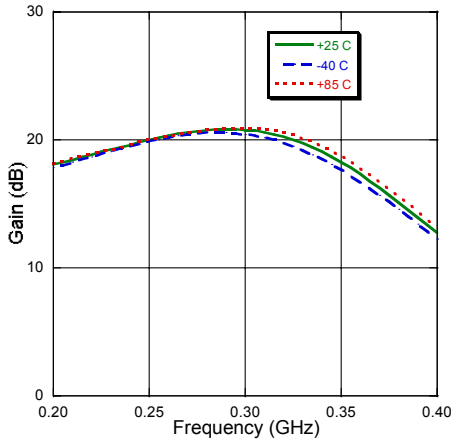

Input Return Loss

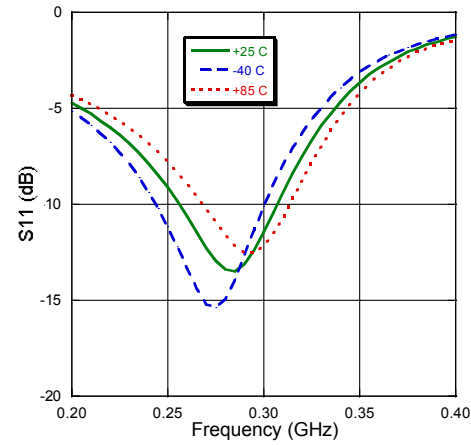

Output Return Loss

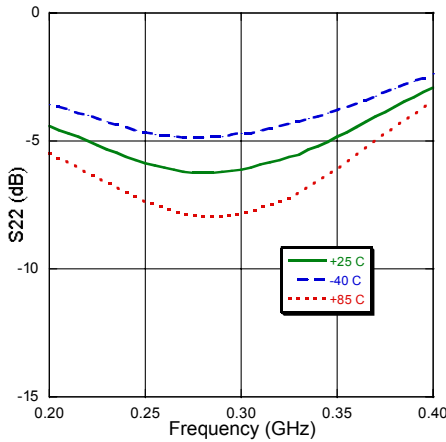

Output IP3

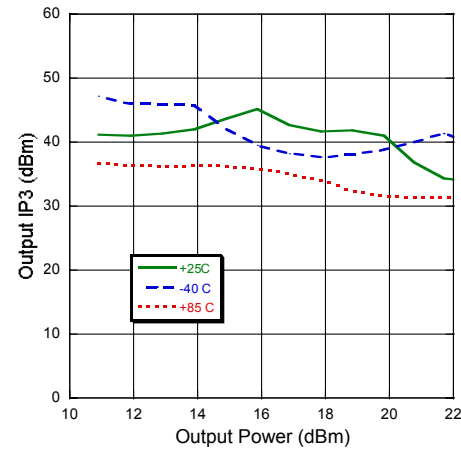

P1dB

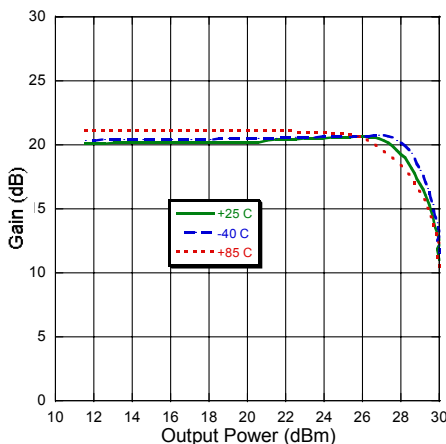

Applications Section

Typical Performance Curves, 2400 MHz Configuration

Gain

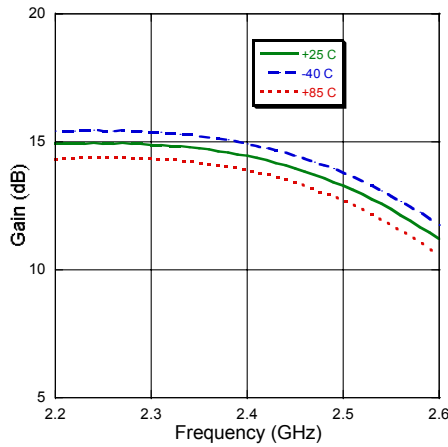

Input Return Loss

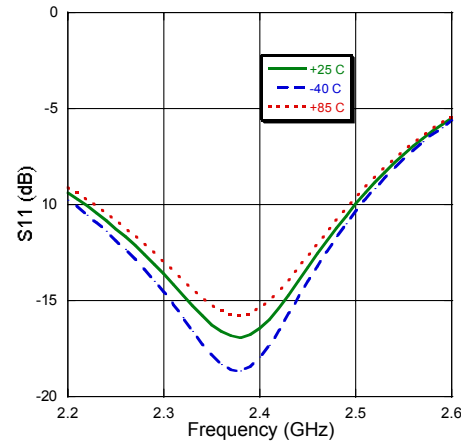

Output Return Loss

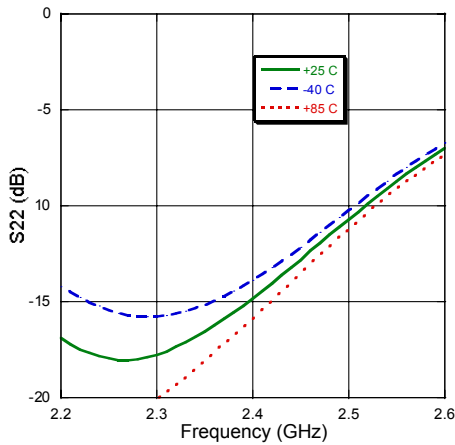

Output IP3

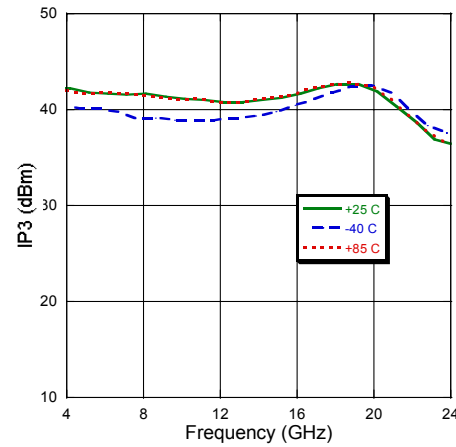

P1dB

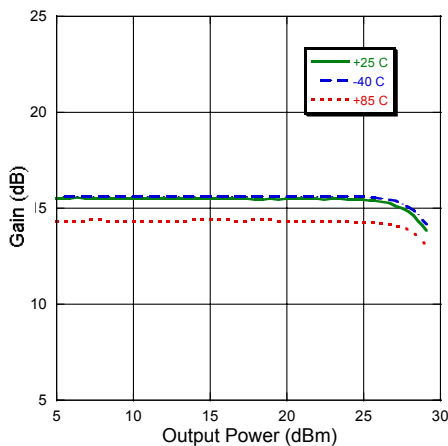

Applications Section

Typical Performance Curves, 3500 MHz Configuration

Gain

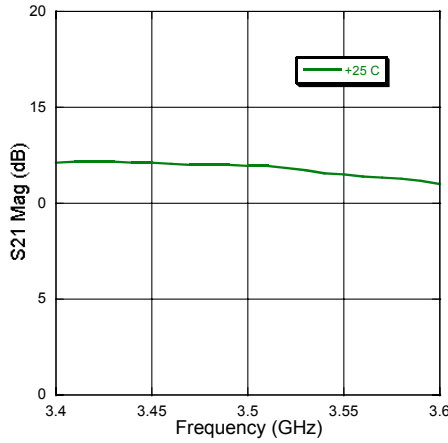

Input Return Loss

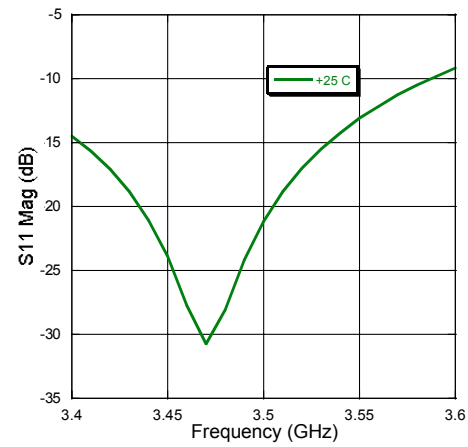

Output Return Loss

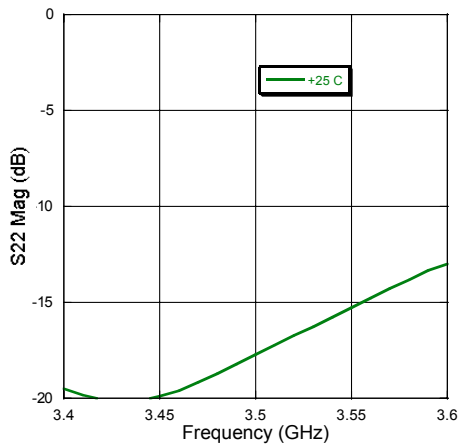

Output IP3

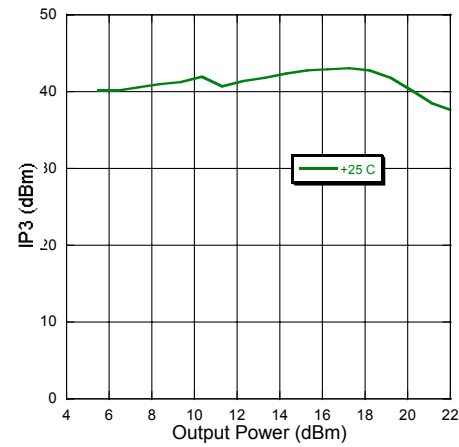

P1dB

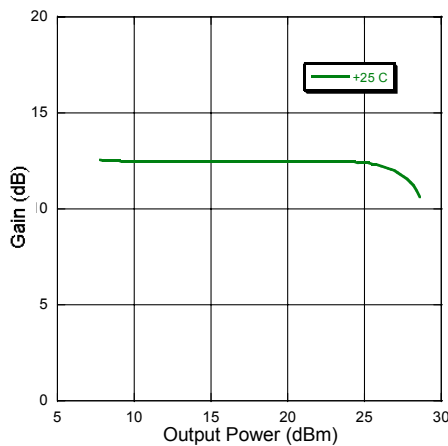

Applications Section

300 MHz PCB Layout

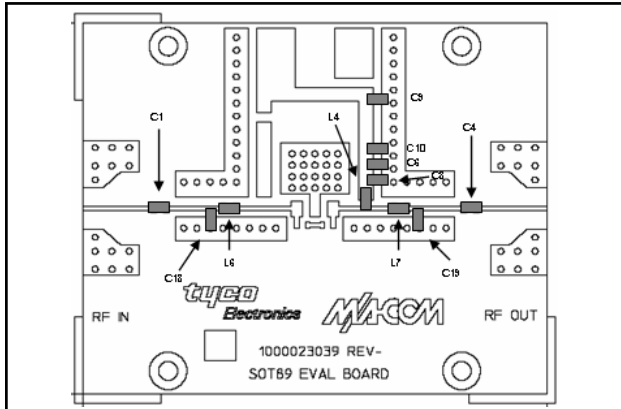

300 MHz Schematic

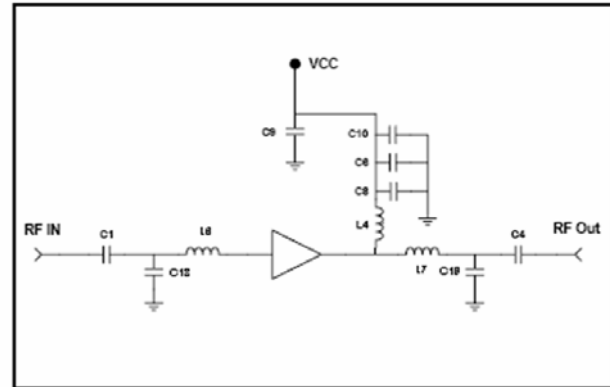

2400 MHz PCB Layout

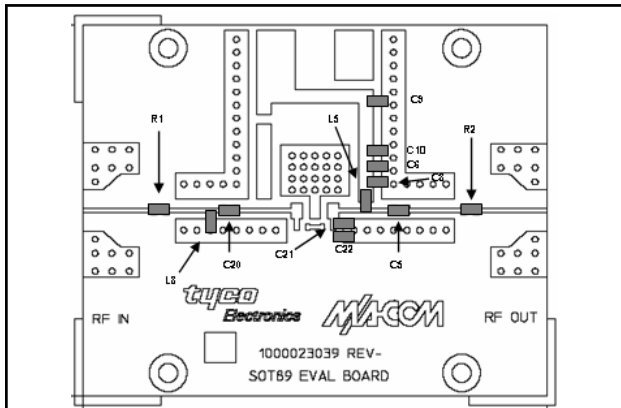

2400 MHz Schematic

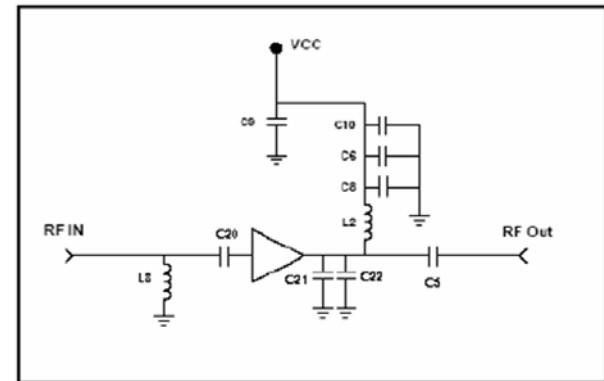

3500 MHz PCB Layout

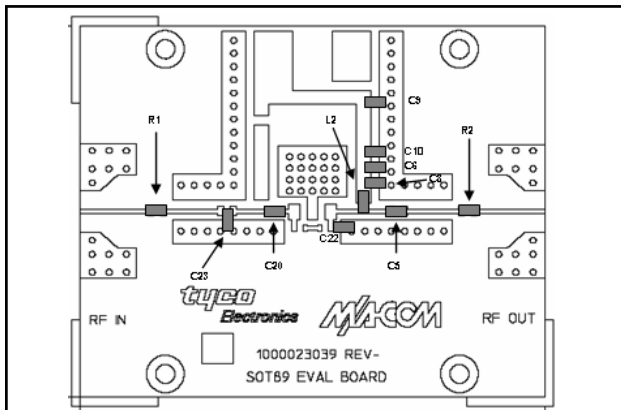

3500 MHz Schematic

