

Field programmable logic array (18 × 42 × 10)

82S153A (PLS153A)

DESCRIPTION

The 82S153A is a two-level logic element, consisting of 42 AND gates and 10 OR gates with fusible link connections for programming I/O polarity and direction.

All AND gates are linked to 8 inputs (I) and 10 bidirectional I/O lines (B). These yield variable I/O gate configurations via 10 directional control gates (D), ranging from 18 inputs to 10 outputs.

On chip T/C buffers couple either True (I, B) or Complement (I, B) input polarities to all AND gates, whose outputs can be optionally linked to all OR gates. their output polarity, in turn, is individually programmable through a set of EX-OR gates for implementing AND/OR or AND/NOR logic functions.

The 82S153A is field programmable, enabling the use to quickly generate custom patterns using standard programming equipment.

FEATURES

- Field-Programmable (Ni-Cr links)
- 8 inputs
- 42 AND gates

- 10 OR gates
- 10 bidirectional I/O lines
- Active-High or -Low outputs
- 42 Product Terms:
 - 32 Logic Terms
 - 10 Control Terms
- I/O propagation delay: 42ns (max)
- Input loading: -150µA (max)
- Power dissipation: 650mW (typ.)
- 3-State outputs
- TTL compatible

APPLICATIONS

- Random logic
- Code converters
- Fault detectors
- Function generators
- Address mapping
- Multiplexing

LOGIC FUNCTION

TYPICAL PRODUCT TERM:
 $P_n = A \cdot B \cdot C \cdot D \dots$
TYPICAL LOGIC FUNCTION:
AT OUTPUT POLARITY = H
 $Z = P_0 + P_1 + P_2 \dots$
AT OUTPUT POLARITY = L
 $Z = P_0 \cdot P_1 \cdot P_2 \dots$

NOTES:
 1. For each of the 10 outputs, either function Z (active-high) or Z (active-low) is available, but not both. The desired output polarity is programmed via the EX-OR gates.
 2. Z, A, B, C etc. are user defined connections to fixed inputs (I) and bidirectional pins (B).

ORDERING INFORMATION

DESCRIPTION	ORDER CODE
20-Pin Ceramic DIP 300mil-wide	82S153A/BRA
20-Pin Ceramic FlatPack	82S153A/BSA
20-Pin Ceramic LLCC	82S153A/B2A

PIN CONFIGURATION

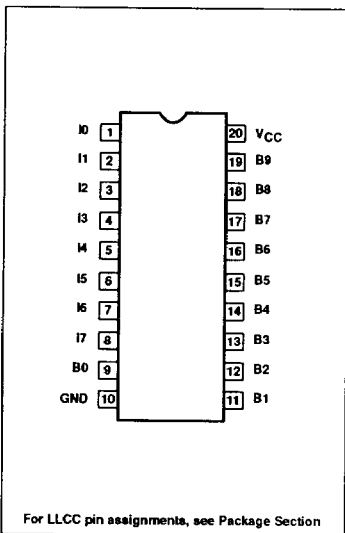

FUNCTIONAL DIAGRAM

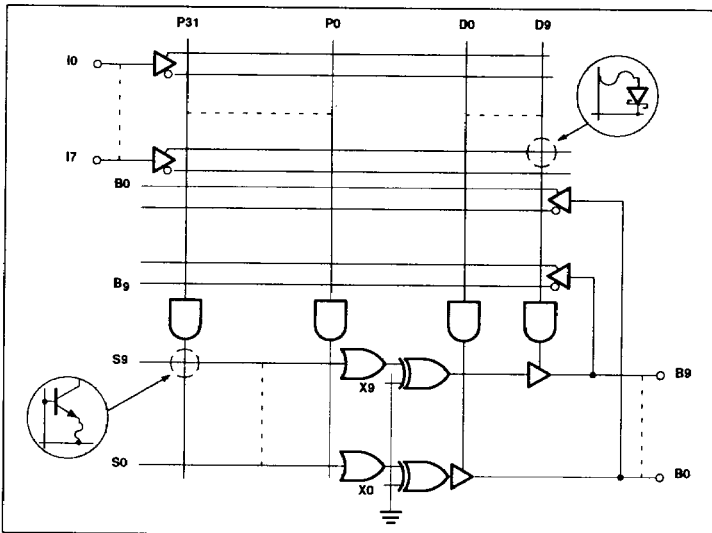

Field programmable logic array (18 × 42 × 10)

82S153A (PLS153A)

FPLA LOGIC DIAGRAM

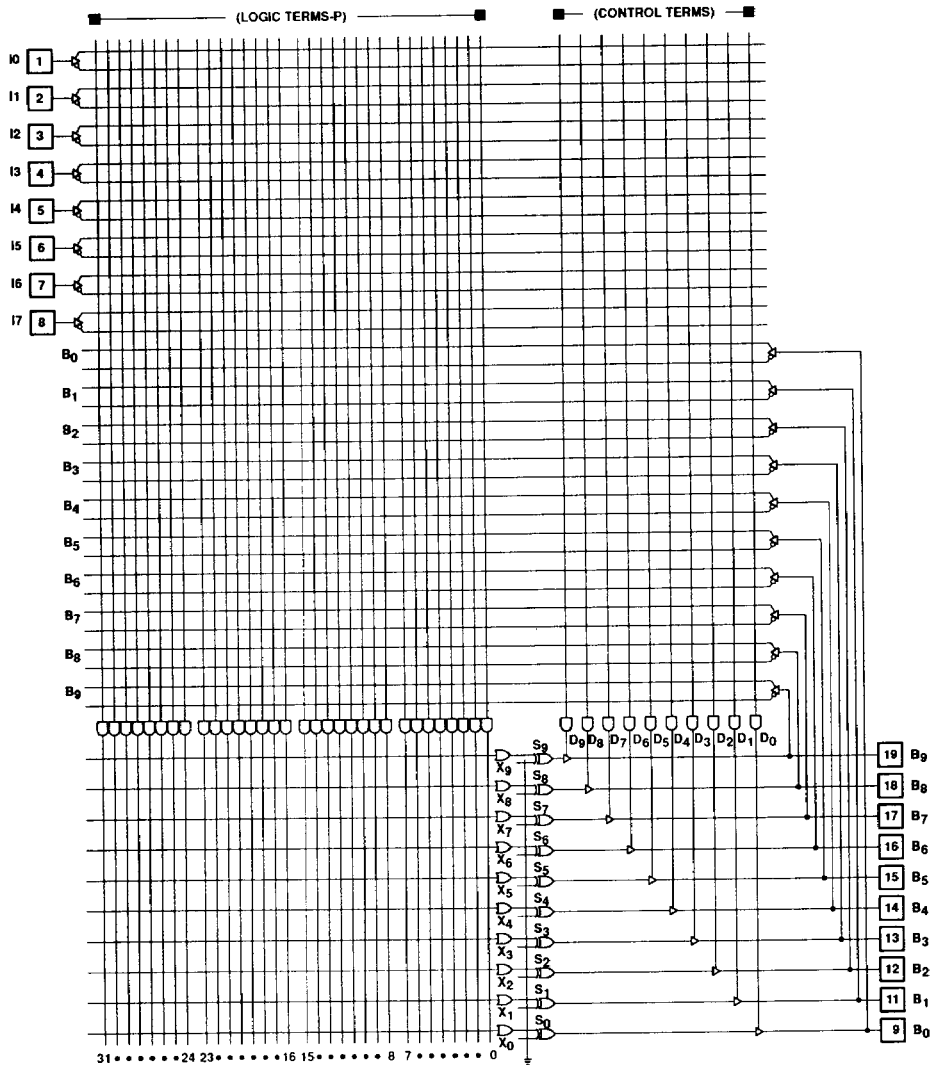

NOTES:

1. All programmed 'AND' gate locations are pulled to logic '1'.
2. All programmed 'OR' gate locations are pulled to logic '0'.
3. Programmable connection.

Field programmable logic array (18 × 42 × 10)

82S153A (PLS153A)

ABSOLUTE MAXIMUM RATINGS¹

SYMBOL	PARAMETER	RATING		UNIT
		MIN	MAX	
V _{CC}	Supply Voltage		+7	V _{DC}
V _I	Input voltage		+10.0	V _{DC}
V _O	Output voltage		+5.5	V _{DC}
I _I	Input currents	-30	+30	mA
I _O	Output currents		+100	mA
T _{amb}	Operating Temperature Range	-55	+125	°C
T _{STG}	Storage Temperature Range	-65	+150	°C

DC ELECTRICAL CHARACTERISTICS

-55°C ≤ T_A ≤ +125°C, 4.5V ≤ V_{CC} ≤ 5.5V

SYMBOL	PARAMETER	TEST CONDITIONS	LIMITS ³			UNIT
			MIN	TYP ²	MAX	
Input Voltage						
V _{IL}	Low	V _{CC} = 4.5V	2.0		0.80	V
V _{IH}	High	V _{CC} = 5.5V			V	
V _{IK}	Clamp ⁴	V _{CC} = 4.5V, I _I = -18mA			-1.2	V
Output Voltage						
V _{OL}	Low ⁵	V _{CC} = 4.5V	2.4		0.5	V
V _{OH}	High ⁶	I _{OL} = 12mA I _{OH} = 2mA				V
Input current						
I _{IL1}	Input pins only	V _{CC} = 5.5V			-150	μA
I _{IH1}	Low High	V _I = 0.45V V _I = 5.5V				
I _{IL2}	I/O pins only	V _{CC} = 5.5V			±210	μA
I _{IH2}	Low High	V _I = 0.45V V _I = 5.5V				
Output current						
I _{O(OFF)}	Hi-Z state ¹⁰	V _{CC} = 5.5V V _O = 5.5V	-15	130	±110	μA
I _{OS}	Short circuit ^{4, 6, 7}	V _O = 0.45V			±210	μA
I _{CC}	V _{CC} supply current ⁸	V _O = 0V V _{CC} = 5.5V			-85	mA
					165	mA
Capacitance¹²						
C _{IN}	Input	V _{CC} = 5V V _I = 2.0V			8	pF
C _B	I/O	V _B = 2.0V			15	20

Field programmable logic array (18 × 42 × 10)

82S153A (PLS153A)

AC ELECTRICAL CHARACTERISTICS

-55°C ≤ T_{amb} ≤ +125°C, 4.5V ≤ V_{CC} ≤ 5.5V

SYMBOL	PARAMETER	TO	FROM	TEST CONDITIONS	LIMITS			UNIT
					MIN	TYP ²	MAX	
t _{PD}	Propagation delay	Output ±	Input ±	C _L = 30pF		20	45	ns
t _{OE}	Output enable	Output ±	Input ±			20	40	ns
t _{OD}	Output disable ^{9, 11}	Output ±	Input ±	C _L = 5pF		20	40	ns

NOTES:

- Stresses above those listed under "Absolute Maximum Ratings" may cause malfunction or permanent damage to the device. This is a stress rating only. Functional operation at these or any other conditions above those indicated in the operational and programming specification of the device is not implied.
- All typical values are at V_{CC} = 5V, T_A = 25°C.
- All voltage values are with respect to network ground terminal.
- Test one at a time.
- Measured with +10V applied to I₇.
- Measured with +10V applied to I_{0, 7}. Output sink current is supplied through a resistor to V_{CC}.
- Duration of short circuit should not exceed 1 second.
- I_{CC} is measured with I_{0, 1} grounded, I_{2, 7} and B_{0, 9} at 4.5V.
- Measured at V_T = V_{OL} + 0.5V.
- Leakage values are a combination of input and output leakage.
- Not testable on unprogrammed device.
- Guaranteed, but not tested.

TIMING DEFINITIONS

SYMBOL	PARAMETER
T _{PD}	Propagation delay between input and output.
T _{DD}	Delay between input change and when output is off (Hi-Z or High).
T _{OE}	Delay between input change and when output reflects specified output level.

TIMING DIAGRAMS

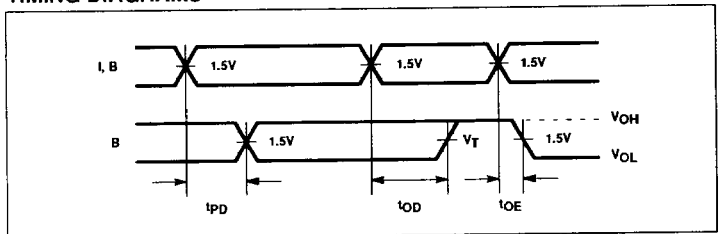

TEST LOAD CIRCUITS

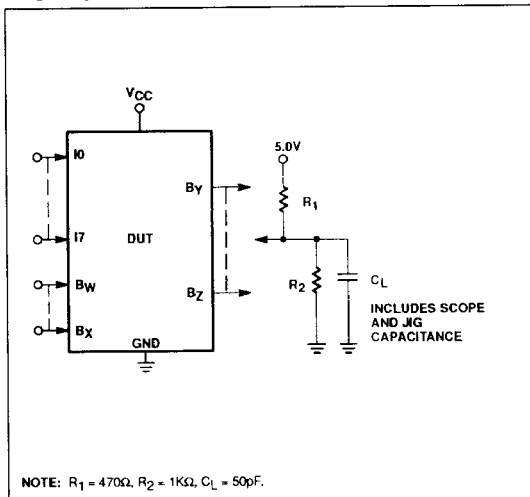

VOLTAGE WAVEFORMS

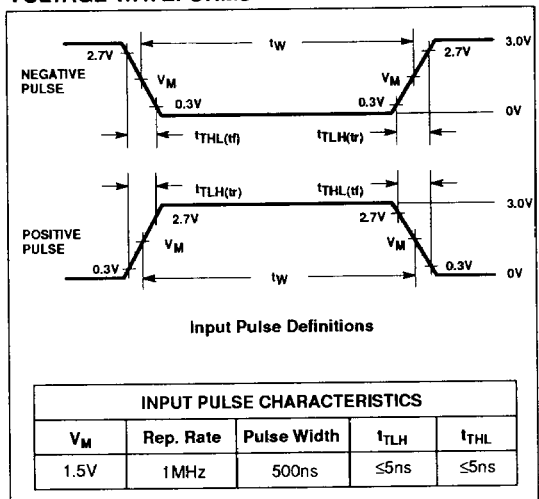

Field programmable logic array (18 × 42 × 10)

82S153A (PLS153A)

LOGIC PROGRAMMING

The FPLA can be programmed by means of Logic programming equipment.

With Logic programming, the AND/OR/EX-OR gate input connections necessary to implement the desired logic function are coded directly from logic equations using the Program Table on the following page.

In this table the logic state of variables I, P, and B associated with each Sum Term S is assigned a symbol which results in the proper fusing pattern of corresponding link pairs, defined as follows:

OUTPUT POLARITY - (B)

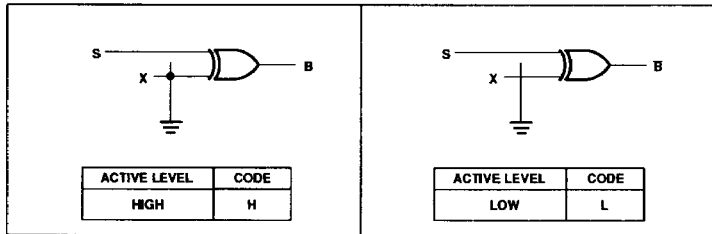

AND ARRAY - (I, B)

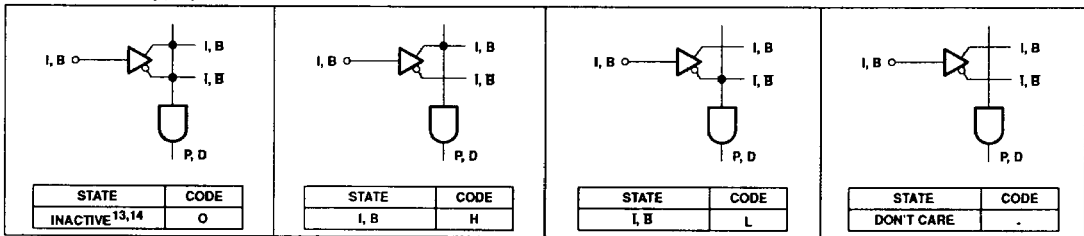

OR ARRAY - (B)

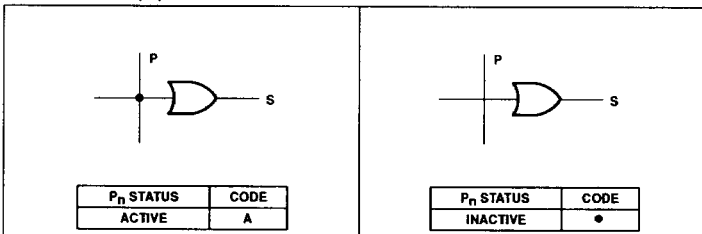

NOTES:

1. This is the initial unprogrammed state of all links.
2. Any gate P_n will be unconditionally inhibited if both the True and Complement of an input (either I or B) are left intact.

VIRGIN STATE

A factory shipped virgin device contains all fusible links intact, such that:

1. All outputs are at "H" polarity.
2. All P_n terms are disabled.
3. All P_n terms are active on all outputs.

CAUTION: 82S153A TEST COLUMNS

The 82S153A incorporates two columns not shown in the logic block diagram. These columns are used for in-house testing of the device in the unprogrammed state. These columns must be disabled prior to using the 82S153A in your application. If you are using a Signetics-approved programmer, the disabling is accomplished during the device programming sequence. If these columns are not disabled, abnormal operation is possible.

Field programmable logic array (18 × 42 × 10)

82S153A (PLS153A)

TWX TAPE CODING (LOGIC FORMAT)

The FPLA Program Table can be sent to Signetics in ASCII code format via airmail using any type of 8-level tape (paper, mylar,

fanfold, etc.), or via TWX: just dial (910) 339-9283, tell the operator to turn the paper puncher on, and acknowledge. At the end of transmission instruct the operator to send tape to Signetics Order Entry.

A number of Program Tables can be sequentially assembled on a continuous tape as follows, however, limit tape length to a roll of 1.75 inch inside diameter and 4.25 outside diameter.

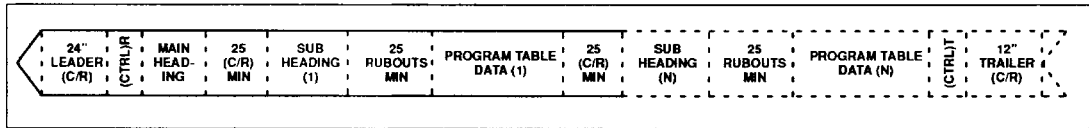

A. The MAIN HEADING at the beginning of tape includes the following information, with each entry preceded by a (\$) character, whether used or not:

- | | |
|---------------------------|-----------------------------------|
| 1. Customer Name _____ | 4. Purchase Order No. _____ |
| 2. Customer TWX No. _____ | 5. Number of Program Tables _____ |
| 3. Date _____ | 6. Total Number of Parts _____ |

B. Each SUB HEADING should contain specific information pertinent to each Program Table as follows, with each entry preceded by a (\$) character, whether used or not:

- | | |
|-------------------------------|---------------------------------------|
| 1. Signetics Device No. _____ | 4. Date _____ |
| 2. Program Table No. _____ | 5. Customer Symbolized Part No. _____ |
| 3. Revision _____ | 6. Number of Parts _____ |

C. Program Table data blocks are initiated with an STX character, and terminated with an ETX character. The body of the data consists of output polarity, product term, and output information separated by appropriate identifiers in accordance with the following format. Entries for the data fields correspond to those defined in the Logic PROGRAM TABLE:

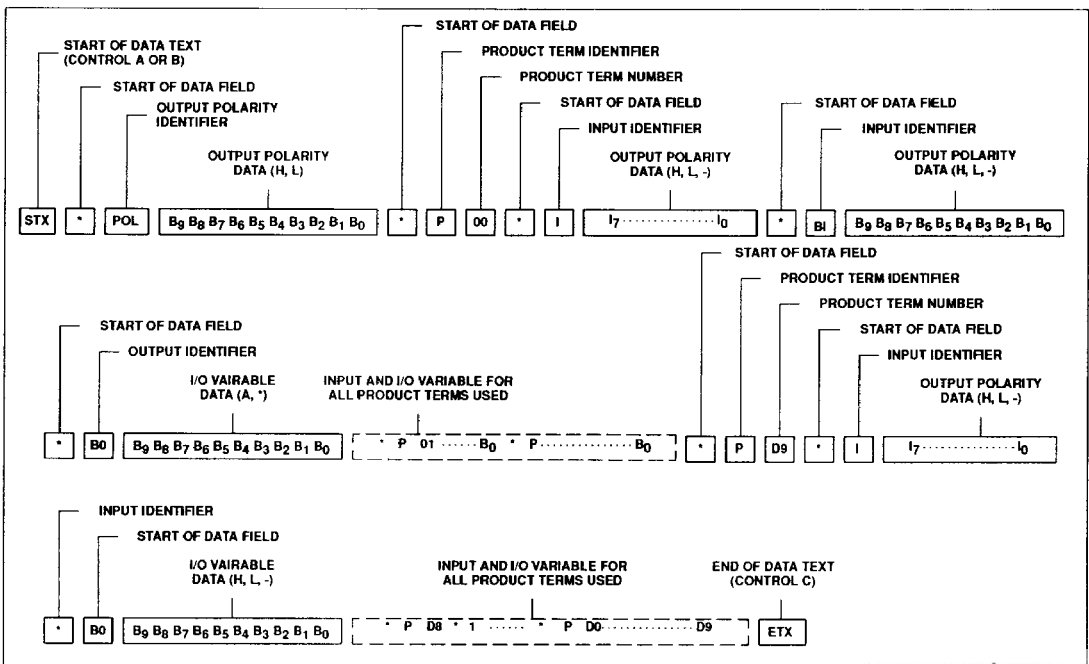

Packaging Information

T-90-20

SIGNETICS STANDARD
PACKAGE DESCRIPTIONS

All Military package case outlines and physical dimensions conform with the current revision MIL-M-38510, Appendix C, except for package types which are not included in that specification.

The physical dimensions for standard package types which are not included in Appendix C are included herein in Appendix C format. Case outline letters are assigned to these packages according to JEDEC Publication 101 as follows:

- U: Leadless chip carriers
- X: Dual-in-line packages
- Y: Flat packages
- Z: All other configurations

A case outline suffix number is assigned herein for identification purposes only, and is not marked on the product.

Signetics Military products are offered in a wide range of package configurations to optimally fit our customer needs.

- Dual-in-line Packages; Frit glass sealed CERDIP (F package family) with 8-40 leads, and side-brazed ceramic (I package family) with 48-64 leads.
- Flat Packages; Frit glass sealed alumina CERPAC (W package family) with 14-28 leads, and brazed leaded ceramic (Q package family) with 52 leads.

- Ceramic Chip Carriers; triple laminated, metal-lidded LCC (G package family) with 20-68 terminals.
- Pin Grid Array; metal-lidded ceramic pin grid (P package family) with 68-100 leads.
- Shown in Table 1 are the case outline letters assigned according to Appendix C of MIL-M-38510 and JEDEC publication 101. Unless otherwise noted, all package types are Configuration 1 and all lead finishes are hot solder dip Finish "A".

Table 1.

Package Description	Type Designation	Case Outline	Theta-JC °C/Watt ⁴
8DIP3	D-4	P	28
14DIP3	D-1	C	28
16DIP3	D-2	E	28
18DIP3	D-6	V	28
20DIP3	D-8	R	28
22DIP4	D-7	W	28
24DIP3	D-9	L	28
24DIP4	D-11	X ²	28
24DIP6	D-3	J	28
28DIP6	D-10	X ²	28
40DIP6	D-5	Q	28
48DIP6	D-14 ¹	X ²	28
50DIP9	D-12 ¹	X ²	28
64DIP9	D-13 ¹	X ²	28
14FLAT	F-2	D	22
16FLAT	F-5	F	22
18FLAT	F-10	Y ²	22
20FLAT	F-9	S	22
24FLAT	F-6	K	22
28FLAT	F-11	Y ²	22
52FLAT	Y-1 ¹	Y ²	22
18LLCC	C-9	U ²	20
20LLCC	C-2 ³	2	20
28LLCC	C-4 ³	3	20
32LLCC	C-12	U ²	20
44LLCC	C-5	U ²	20
68LLCC	C-7	U ²	20
68PGA	P-AB	Z ²	20
84PGA	P-AB	Z ²	20

NOTES:

1. Configuration 2.
2. Per JEDEC publication 101.
3. Dimension A (LLCC thickness) is 75mils maximum.
4. See RADC test report RADC-TR-86-97 for thermal resistance confidence and derating.

CASE OUTLINES Y (FLAT PACKAGES)

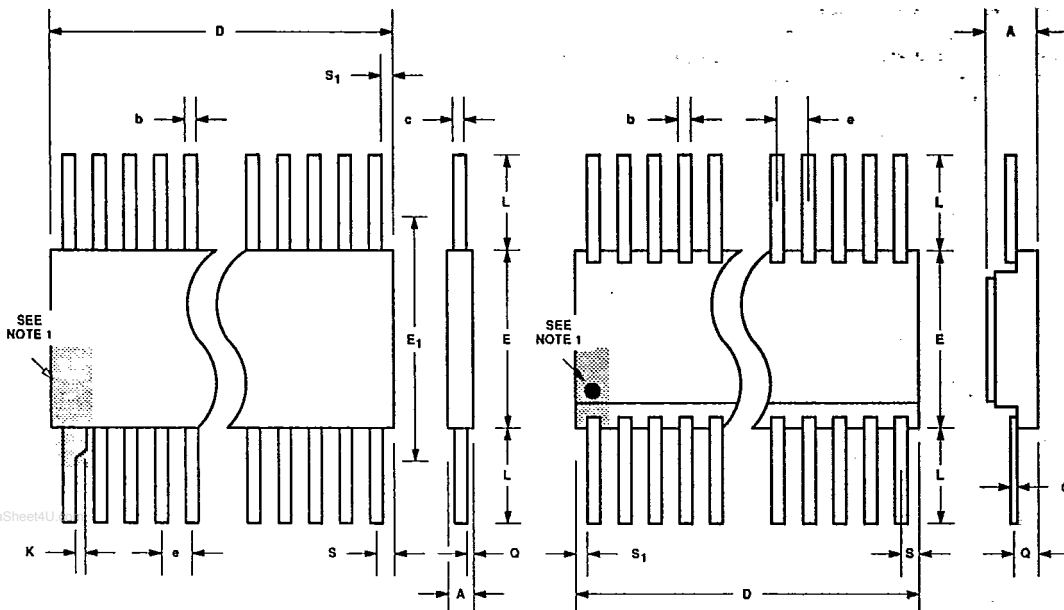

Configuration 1

Configuration 2

NOTES:

1. A lead tab (enlargement) or index dot is located within the shaded area shown at Pin 1. Other pin numbers proceed sequentially from Pin 1 counter-clockwise (as viewed from the top of the device).
2. This dimension allows for off-center lid, meniscus and glass overrun.
3. The reference pin spacing is 0.050 between centerlines. Each pin centerline is located within ± 0.005 of its longitudinal position relative to the first and last pin numbers.
4. This dimension is measured at the point of exit of the lead body.
5. This dimension applied to all four corner pins.
6. Lead dimensions include 0.003 inch allowance for hot solder dip lead finish

OUTLINE	Y1		NOTES
CONFIGURATION	2		
NO. LEADS	52		
SIG. PKG.	QP		
SYMBOL	INCHES		
	MIn	Max	
A	0.045	0.100	
b	0.015	0.026	6
c	0.008	0.015	6
D	-	1.330	2
E	0.620	0.660	
e	0.050BSC		3
L	0.250	0.370	
Q	0.054	0.0666	4
S	-	0.045	5
S1			

CASE OUTLINES X (DUAL IN-LINE PACKAGES)

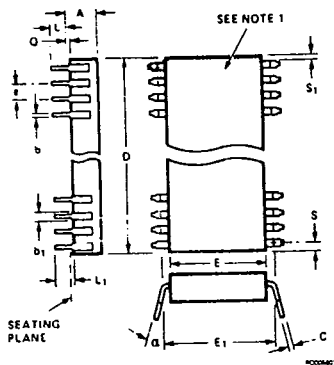

Configuration 1

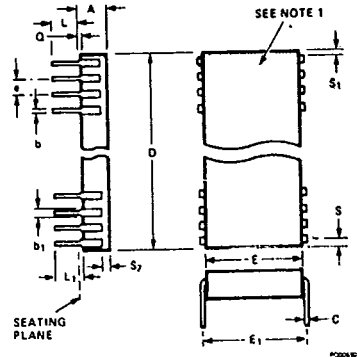

Configuration 2

1. An index notch is located within the shaded area shown. Pin 1 is adjacent to the notch to the immediate left (as viewed from the top of the device) and other pin numbers proceed sequentially from Pin 1 counterclockwise.
2. The minimum limit for Dimension b_1 is 0.023 inches for all four corner pins.
3. This dimension allows for off-center lid, meniscus, and glass overrun.
4. This dimension is measured at the centerline of the leads for Configuration 2.
5. The reference pin spacing is 0.100 between centerlines. Each pin centerline is located within ± 0.010 of its longitudinal position relative to the first and last pin numbers.
6. This dimension is measured from the seating plane to the base plane.
7. This dimension applies to all four corner pins.
8. Lead dimensions include 0.003 inch allowance for hot solder dip lead finish.

LEADLESS CHIP CARRIER (LLCC) PINOUTS

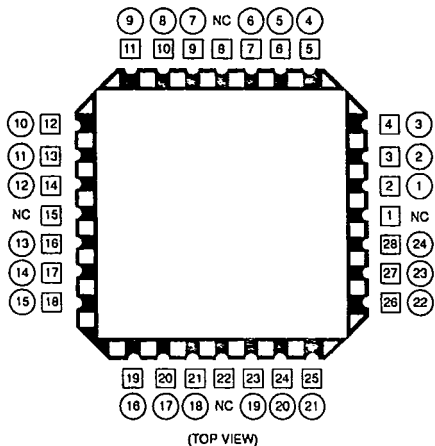

24-Lead Logic Pinout for 28 Terminal Chip Carrier

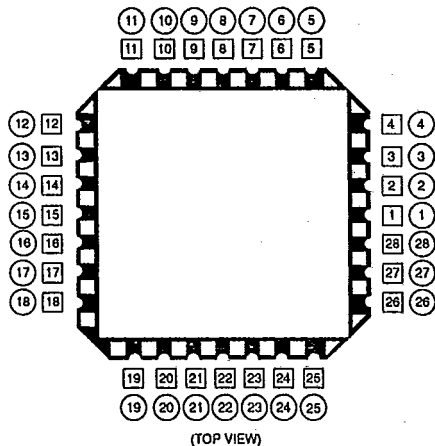

28-Lead Pinout for 28 Terminal Chip Carrier for all Device Types

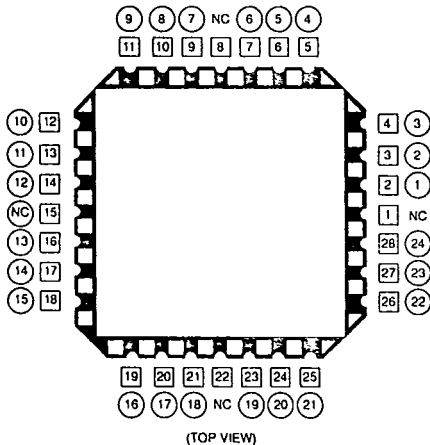

24-Lead Memory Pinout for 28 Terminal Chip Carrier

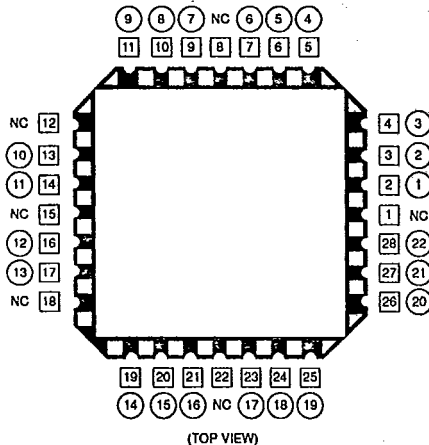

22-Lead Memory Pinout for 28 Terminal Chip Carrier

- = Chip Carrier Terminal Number
- = Dual In-Line Lead Number
- NC = No Connect

LEADLESS CHIP CARRIER (LLCC) PINOUTS

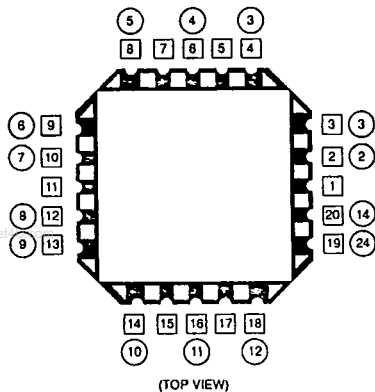

14-Pin Logic Pinout for 20 Terminal Chip Carrier

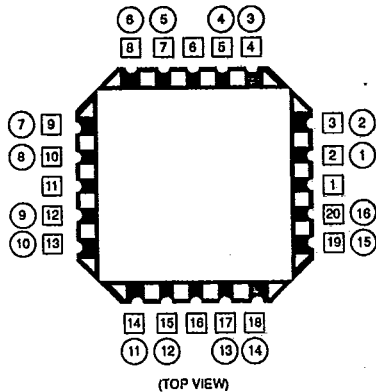

16-Pin Logic Pinout for 20 Terminal Chip Carrier

- - Chip Carrier Terminal Number
- - Dual In-Line Load Number