

TK15H50C

○ Switching Regulator Applications

- Low drain-source ON resistance : $R_{DS(ON)} = 0.33 \Omega$ (typ.)
- High forward transfer admittance : $|Y_{fs}| = 8.5 S$ (typ.)
- Low leakage current : $I_{DSS} = 100 \mu A$ (max) ($V_{DS} = 500 V$)
- Enhancement mode : $V_{th} = 2.0 \sim 4.0 V$ ($V_{DS} = 10 V, I_{45D} = 1 mA$)

Absolute Maximum Ratings ($T_a = 25^\circ C$)

Characteristic		Symbol	Rating	Unit
Drain-source voltage		V_{DSS}	500	V
Drain-gate voltage ($R_{GS} = 20 k\Omega$)		V_{DGR}	500	V
Gate-source voltage		V_{GSS}	± 30	V
Drain current	DC (Note 1)	I_D	15	A
	Pulse (Note 1)	I_{DP}	60	A
Drain power dissipation ($T_c = 25^\circ C$)		P_D	150	W
Single-pulse avalanche energy (Note 2)		E_{AS}	765	mJ
Avalanche current		I_{AR}	15	A
Repetitive avalanche energy (Note 3)		E_{AR}	15	mJ
Channel temperature		T_{ch}	150	$^\circ C$
Storage temperature range		T_{stg}	-55~150	$^\circ C$

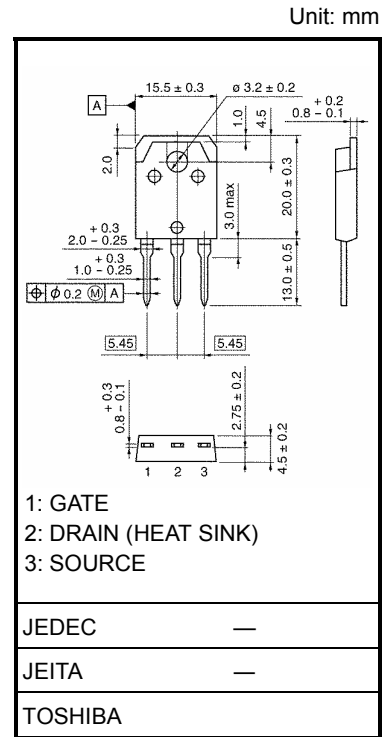

Weight: 3.8 g (typ.)

Note: Using continuously under heavy loads (e.g. the application of high temperature/current/voltage and the significant change in temperature, etc.) may cause this product to decrease in the reliability significantly even if the operating conditions (i.e. operating temperature/current/voltage, etc.) are within the absolute maximum ratings. Please design the appropriate reliability upon reviewing the Toshiba Semiconductor Reliability Handbook ("Handling Precautions"/Derating Concept and Methods) and individual reliability data (i.e. reliability test report and estimated failure rate, etc).

Thermal Characteristics

Characteristic	Symbol	Max	Unit
Thermal resistance, channel to case	$R_{th(ch-c)}$	0.833	$^\circ C/W$
Thermal resistance, channel to ambient	$R_{th(ch-a)}$	50	$^\circ C/W$

- Note 1: Ensure that the channel temperature does not exceed $150^\circ C$.
 Note 2: $V_{DD} = 90 V, T_{ch} = 25^\circ C$ (initial), $L = 5.78 mH, R_G = 25 \Omega, I_{AR} = 15 A$
 Note 3: Repetitive rating: pulse width limited by maximum channel temperature
 This transistor is an electrostatic-sensitive device. Handle with care.

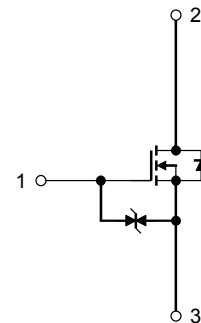

Electrical Characteristics (Ta = 25°C)

Characteristic	Symbol	Test Condition	Min	Typ.	Max	Unit	
Gate leakage current	I_{GSS}	$V_{GS} = \pm 25\text{ V}, V_{DS} = 0\text{ V}$	—	—	± 10	μA	
Gate-source breakdown voltage	$V_{(BR)GSS}$	$I_G = \pm 10\ \mu\text{A}, V_{DS} = 0\text{ V}$	± 30	—	—	V	
Drain cutoff current	I_{DSS}	$V_{DS} = 500\text{ V}, V_{GS} = 0\text{ V}$	—	—	100	μA	
Drain-source breakdown voltage	$V_{(BR)DSS}$	$I_D = 10\text{ mA}, V_{GS} = 0\text{ V}$	500	—	—	V	
Gate threshold voltage	V_{th}	$V_{DS} = 10\text{ V}, I_D = 1\text{ mA}$	2.0	—	4.0	V	
Drain-source ON resistance	$R_{DS(ON)}$	$V_{GS} = 10\text{ V}, I_D = 7.0\text{ A}$	—	0.33	0.4	Ω	
Forward transfer admittance	$ Y_{fs} $	$V_{DS} = 10\text{ V}, I_D = 7.0\text{ A}$	4.0	8.5	—	S	
Input capacitance	C_{iss}	$V_{DS} = 25\text{ V}, V_{GS} = 0\text{ V}, f = 1\text{ MHz}$	—	2450	—	pF	
Reverse transfer capacitance	C_{rss}		—	15	—		
Output capacitance	C_{oss}		—	220	—		
Switching time	Rise time	t_r		—	50	—	ns
	Turn-on time	t_{on}		—	90	—	
	Fall time	t_f		—	45	—	
	Turn-off time	t_{off}		—	175	—	
Total gate charge (gate-source plus gate-drain)	Q_g	$V_{DD} \approx 400\text{ V}, V_{GS} = 10\text{ V}, I_D = 15\text{ A}$	—	48	—	nC	
Gate-source charge	Q_{gs}		—	26	—		
Gate-drain ("Miller") charge	Q_{gd}		—	22	—		

Source-Drain Ratings and Characteristics (Ta = 25°C)

Characteristic	Symbol	Test Condition	Min	Typ.	Max	Unit
Continuous drain reverse current (Note 1)	I_{DR}	—	—	—	15	A
Pulse drain reverse current (Note 1)	I_{DRP}	—	—	—	60	A
Forward voltage (diode)	V_{DSF}	$I_{DR} = 15\text{ A}, V_{GS} = 0\text{ V}$	—	—	-1.7	V
Reverse recovery time	t_{rr}	$I_{DR} = 15\text{ A}, V_{GS} = 0\text{ V}$	—	1050	—	ns
Reverse recovery charge	Q_{rr}	$dI_{DR} / dt = 100\text{ A} / \mu\text{s}$	—	13	—	μC

Marking

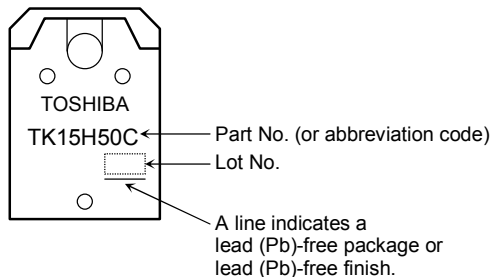

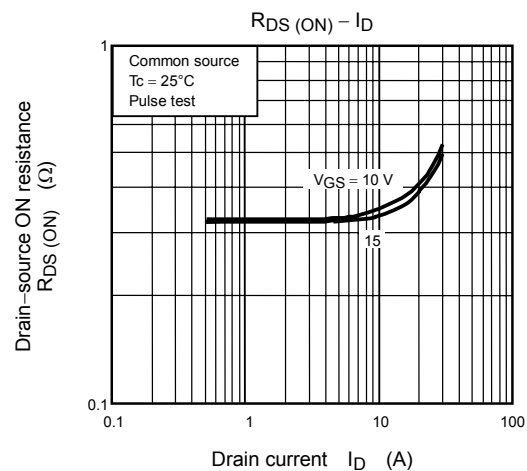
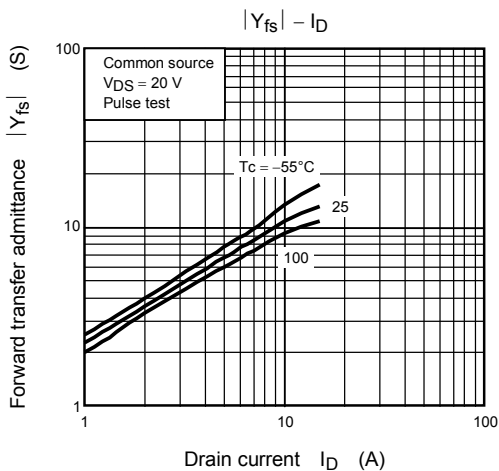
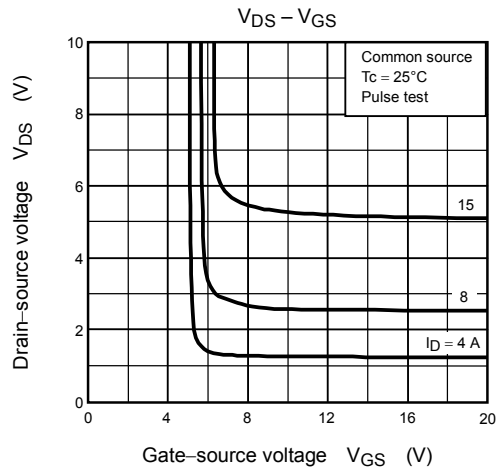
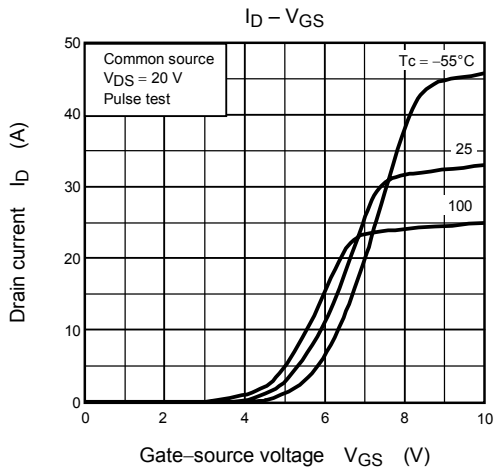
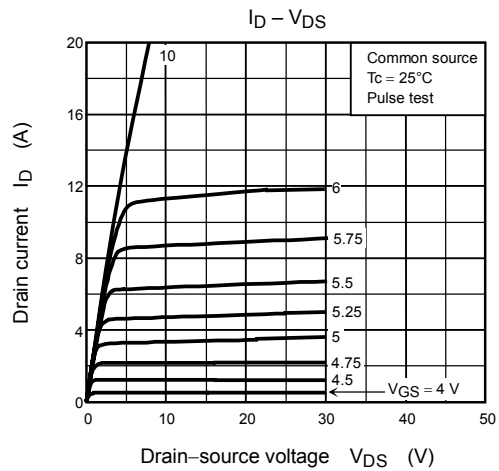
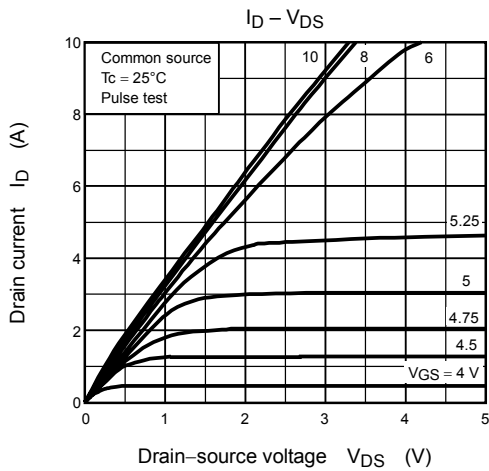

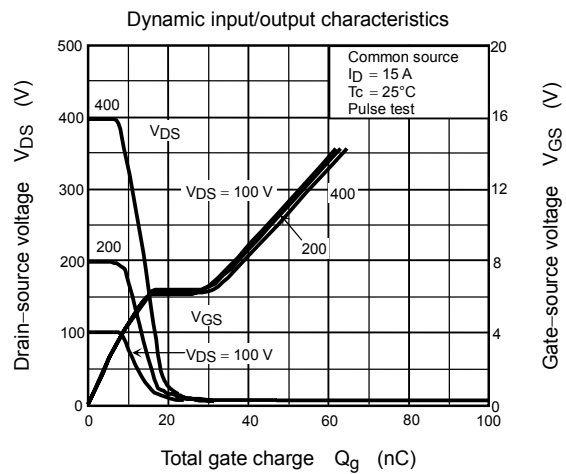
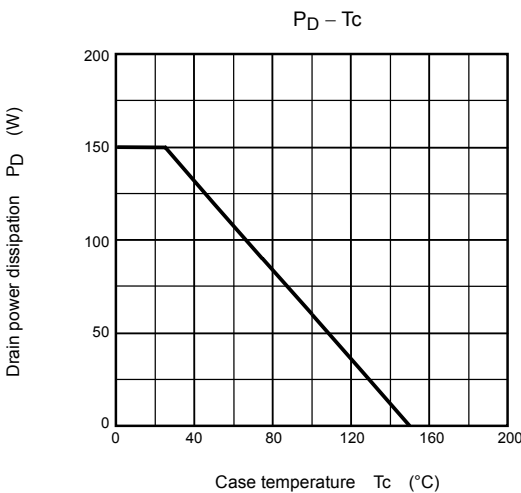
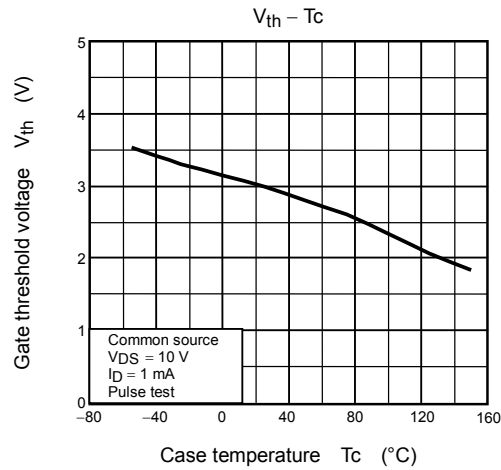
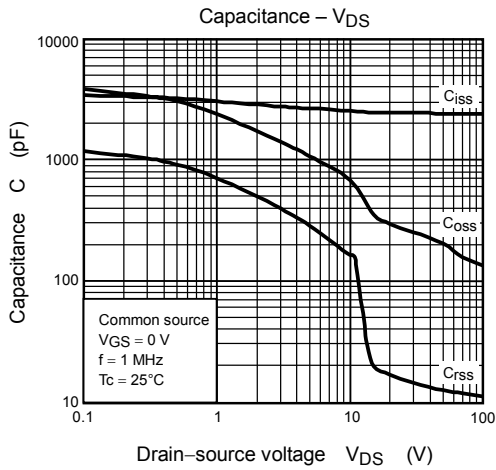
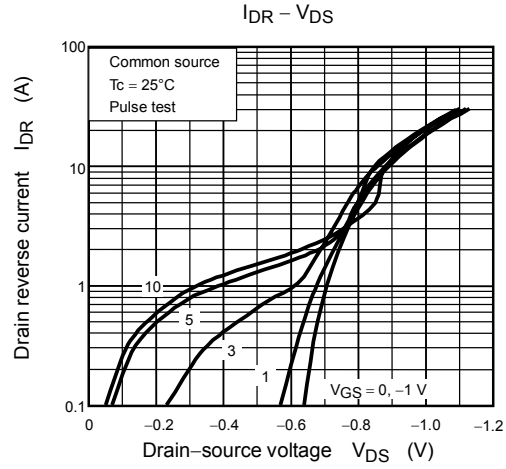
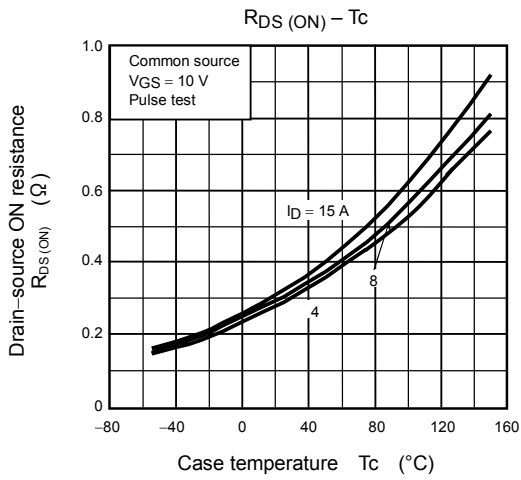

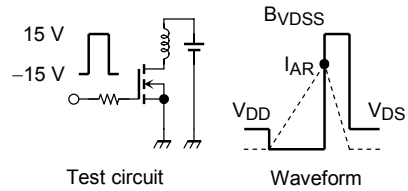
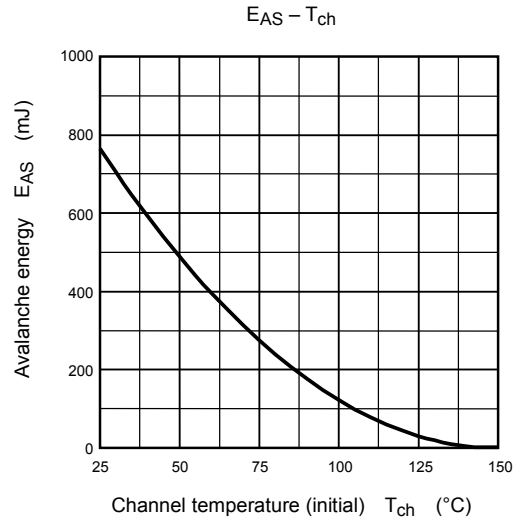
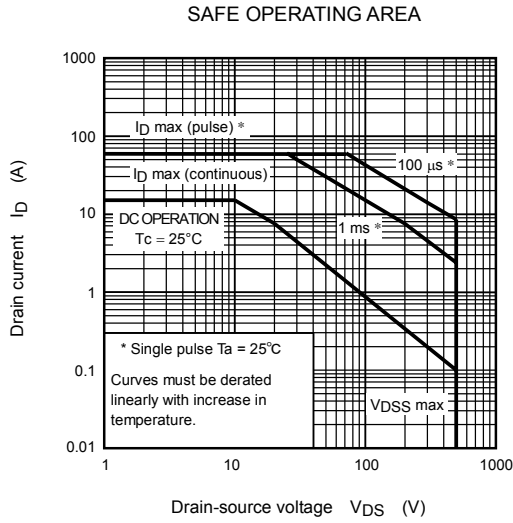
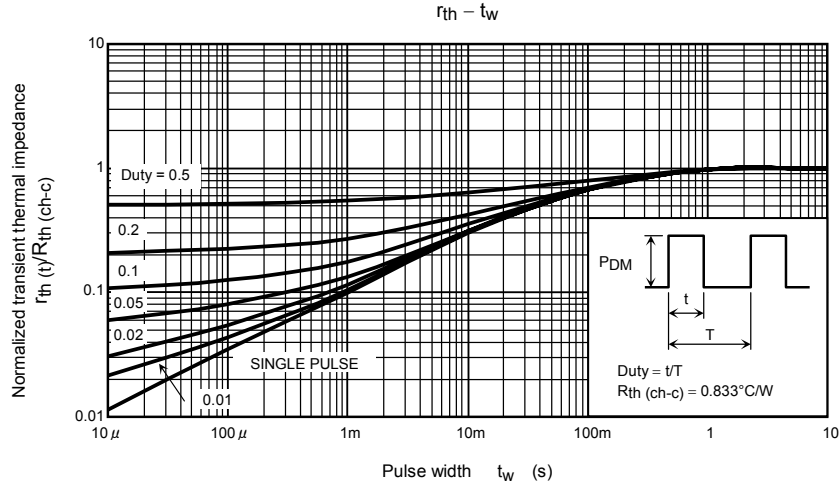

$R_G = 25 \Omega$
 $V_{DD} = 90 \text{ V}, L = 5.78 \text{ mH}$

$$E_{AS} = \frac{1}{2} \cdot L \cdot I_{AR}^2 \cdot \left(\frac{B_{VDSS}}{B_{VDSS} - V_{DD}} \right)$$

RESTRICTIONS ON PRODUCT USE

030619EAA

- The information contained herein is subject to change without notice.
- The information contained herein is presented only as a guide for the applications of our products. No responsibility is assumed by TOSHIBA for any infringements of patents or other rights of the third parties which may result from its use. No license is granted by implication or otherwise under any patent or patent rights of TOSHIBA or others.
- TOSHIBA is continually working to improve the quality and reliability of its products. Nevertheless, semiconductor devices in general can malfunction or fail due to their inherent electrical sensitivity and vulnerability to physical stress. It is the responsibility of the buyer, when utilizing TOSHIBA products, to comply with the standards of safety in making a safe design for the entire system, and to avoid situations in which a malfunction or failure of such TOSHIBA products could cause loss of human life, bodily injury or damage to property.
In developing your designs, please ensure that TOSHIBA products are used within specified operating ranges as set forth in the most recent TOSHIBA products specifications. Also, please keep in mind the precautions and conditions set forth in the "Handling Guide for Semiconductor Devices," or "TOSHIBA Semiconductor Reliability Handbook" etc..
- The TOSHIBA products listed in this document are intended for usage in general electronics applications (computer, personal equipment, office equipment, measuring equipment, industrial robotics, domestic appliances, etc.). These TOSHIBA products are neither intended nor warranted for usage in equipment that requires extraordinarily high quality and/or reliability or a malfunction or failure of which may cause loss of human life or bodily injury ("Unintended Usage"). Unintended Usage include atomic energy control instruments, airplane or spaceship instruments, transportation instruments, traffic signal instruments, combustion control instruments, medical instruments, all types of safety devices, etc.. Unintended Usage of TOSHIBA products listed in this document shall be made at the customer's own risk.
- TOSHIBA products should not be embedded to the downstream products which are prohibited to be produced and sold, under any law and regulations.