

MICRO ELECTRONICS

ML7800 SERIES

3-TERMINAL POSITIVE VOLTAGE REGULATOR

The ML7800 series are 3-Terminal Positive Voltage Regulators. These regulators employ internal current-limiting, thermal-shutdown and safe-area compensation, making them essentially indestructible. If adequate heat sinking is provided, they can deliver over 1A output current (Please refer to the "thermal design" portion of application note). They are intended as fixed voltage regulations in a wide range of applications including local (on-card) regulation for elimination of distribution problems associated with single point regulation. In addition to use as fixed voltage regulators, these devices can be used with external components to obtain adjustable output voltages and currents.

■ Package Outline

TO-220

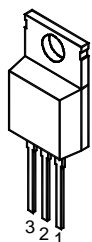

1. OUT
2. GND
3. IN

TO-220F

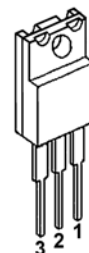

ABSOLUTE MAXIMUM RATINGS (Ta=25°C)

PARAMETER	SYMBOL	Maximum Rating		UNIT	
Input Voltage	V _{IN}	ML7805 to ML7809	35	V	
		ML7812 to ML7820	35		
		ML7824	40		
Storage Temperature Range	T _{stg}	-40 to +125		°C	
Operating Temperature Range	Operating Junction Temperature		T _j	-30 to +150	°C
	Operating Ambient Temperature		T _{opr}	-30 to +75	
Power Dissipation	P _d	15(T _c ≤ 70°C)		W	

THERMAL RESISTANCE

Thermal Resistance	Junction-to-Ambient Temperature	θ _{ja}	60	°C/W
	Junction-to-Case	θ _{jc}	5	

ELECTRICAL CHARACTERISTICS (T_j=25°C, C₁=0.33 μF, C_o=0.1 μF)

Measurement is to be conducted in pulse testing.

PARAMETER	SYMBOL	TEST CONDITIONS		MIN.	TYP.	MAX.	UNIT	
ML7805A / ML7805FA								
Output Voltage	V _o	V _{IN} =10V	I _o =0.5A	4.8	5.0	5.2	V	
Quiescent Current	I _q	V _{IN} =10V	I _o =0mA	-	4.2	8.0	mA	
Load Regulation	ΔV _o I _o	V _{IN} =10V	I _o =0.005A to 1.5A	-	15	100	mV	
Line Regulation	ΔV _o V _{in}	V _{IN} =7 to 25V	I _o =0.5A	-	3	100	mV	
Ripple Rejection	RR	V _{IN} =10V	I _o =0.5A	e _{in} =2V _{p-p}	f=120Hz	62	78	dB
Output Noise Voltage	V _{NO}	V _{IN} =10V	BW=10Hz to 100KHz		I _o =0.5A	-	40	μV
Average Temperature Coefficient of Output Voltage	ΔV _o / ΔT	V _{IN} =10V	I _o =0.5A	-	-1.1	-	mV/°C	



MICRO ELECTRONICS LTD. 美科有限公司
7/F, Enterprise Square Three, 39 Wang Chiu Road, Kowloon Bay, Kowloon, Hong Kong.
TEL: (852) 23430181 FAX: (852) 23410321
HOMEPAGE: <http://www.microelectr.com.hk>

REV B

ELECTRICAL CHARACTERISTICS

(T_j=25°C, C₁=0.33 μF, C_o=0.1 μF)

Measurement is to be conducted in pulse testing.

PARAMETER	SYMBOL	TEST CONDITIONS				MIN.	TYP.	MAX.	UNIT
ML7806A / ML7806FA									
Output Voltage	V _o	V _{IN} =11V	I _o =0.5A			5.75	6.0	6.25	V
Quiescent Current	I _q	V _{IN} =11V	I _o =0mA			-	4.3	8.0	mA
Load Regulation	Δ V _o I _o	V _{IN} =11V	I _o =0.005A to 1.5A			-	15	120	mV
Line Regulation	Δ V _o V _{in}	V _{IN} =8 to 25V	I _o =0.5A			-	5	120	mV
Ripple Rejection	RR	V _{IN} =11V	I _o =0.5A	Є _{in} =2V _{p-p}	f=120Hz	59	75	-	dB
Output Noise Voltage	V _{NO}	V _{IN} =11V	BW=10Hz to 100KHz		I _o =0.5A	-	45	-	μV
Average Temperature Coefficient of Output Voltage	Δ V _o / Δ T	V _{IN} =11V	I _o =5mA			-	-0.8	-	mV/°C
ML7808A / ML7808FA									
Output Voltage	V _o	V _{IN} =14V	I _o =0.5A			7.7	8.0	8.3	V
Quiescent Current	I _q	V _{IN} =14V	I _o =0mA			-	4.3	8.0	mA
Load Regulation	Δ V _o I _o	V _{IN} =14V	I _o =0.005A to 1.5A			-	15	160	mV
Line Regulation	Δ V _o V _{in}	V _{IN} =10.5 to 25V	I _o =0.5A			-	6	160	mV
Ripple Rejection	RR	V _{IN} =14V	I _o =0.5A	Є _{in} =2V _{p-p}	f=120Hz	55	72	-	dB
Output Noise Voltage	V _{NO}	V _{IN} =14V	BW=10Hz to 100KHz		I _o =0.5A	-	52	-	μV
Average Temperature Coefficient of Output Voltage	Δ V _o / Δ T	V _{IN} =14V	I _o =5mA			-	-0.8	-	mV/°C
ML7809A / ML7809FA									
Output Voltage	V _o	V _{IN} =15V	I _o =0.5A			8.65	9.0	9.35	V
Quiescent Current	I _q	V _{IN} =15V	I _o =0mA			-	4.3	8.0	mA
Load Regulation	Δ V _o I _o	V _{IN} =15V	I _o =0.005A to 1.5A			-	15	180	mV
Line Regulation	Δ V _o V _{in}	V _{IN} =11.5 to 25V	I _o =0.5A			-	7	180	mV
Ripple Rejection	RR	V _{IN} =15V	I _o =0.5A	Є _{in} =2V _{p-p}	f=120Hz	55	70	-	dB
Output Noise Voltage	V _{NO}	V _{IN} =15V	BW=10Hz to 100KHz		I _o =0.5A	-	60	-	μV
Average Temperature Coefficient of Output Voltage	Δ V _o / Δ T	V _{IN} =15V	I _o =5mA			-	-1	-	mV/°C
ML7812A / ML7812FA									
Output Voltage	V _o	V _{IN} =19V	I _o =0.5A			11.5	12.0	12.5	V
Quiescent Current	I _q	V _{IN} =19V	I _o =0mA			-	4.3	8.0	mA
Load Regulation	Δ V _o I _o	V _{IN} =19V	I _o =0.005A to 1.5A			-	25	240	mV
Line Regulation	Δ V _o V _{in}	V _{IN} =14.5 to 30V	I _o =0.5A			-	10	240	mV
Ripple Rejection	RR	V _{IN} =19V	I _o =0.5A	Є _{in} =2V _{p-p}	f=120Hz	55	71	-	dB
Output Noise Voltage	V _{NO}	V _{IN} =19V	BW=10Hz to 100KHz		I _o =0.5A	-	75	-	μV
Average Temperature Coefficient of Output Voltage	Δ V _o / Δ T	V _{IN} =19V	I _o =5mA			-	-1	-	mV/°C

REV B

ELECTRICAL CHARACTERISTICS ($T_j=25^{\circ}\text{C}$, $C_1=0.33\ \mu\text{F}$, $C_o=0.1\ \mu\text{F}$)

Measurement is to be conducted in pulse testing.

PARAMETER	SYMBOL	TEST CONDITIONS			MIN.	TYP.	MAX.	UNIT
ML7815A / ML7815FA								
Output Voltage	V_o	$V_{IN}=23\text{V}$	$I_o=0.5\text{A}$		14.4	15.0	15.6	V
Quiescent Current	I_Q	$V_{IN}=23\text{V}$	$I_o=0\text{mA}$		-	4.3	8.0	mA
Load Regulation	$\Delta V_o / I_o$	$V_{IN}=23\text{V}$	$I_o=0.005\text{A}$ to 1.5A		-	35	300	mV
Line Regulation	$\Delta V_o / V_{in}$	$V_{IN}=17.5$ to 30V	$I_o=0.5\text{A}$		-	12	300	mV
Ripple Rejection	RR	$V_{IN}=23\text{V}$	$I_o=0.5\text{A}$	$E_{in}=2\text{V}_{p-p}$ $f=120\text{Hz}$	54	70	-	dB
Output Noise Voltage	V_{NO}	$V_{IN}=23\text{V}$	$BW=10\text{Hz}$ to 100KHz	$I_o=0.5\text{A}$	-	90	-	μV
Average Temperature Coefficient of Output Voltage	$\Delta V_o / \Delta T$	$V_{IN}=23\text{V}$	$I_o=5\text{mA}$		-	-1	-	$\text{mV}/^{\circ}\text{C}$
ML7818A / ML7818FA								
Output Voltage	V_o	$V_{IN}=27\text{V}$	$I_o=0.5\text{A}$		17.3	18.0	18.7	V
Quiescent Current	I_Q	$V_{IN}=27\text{V}$	$I_o=0\text{mA}$		-	4.5	8.0	mA
Load Regulation	$\Delta V_o / I_o$	$V_{IN}=27\text{V}$	$I_o=0.005\text{A}$ to 1.5A		-	55	360	mV
Line Regulation	$\Delta V_o / V_{in}$	$V_{IN}=21$ to 33V	$I_o=0.5\text{A}$		-	15	360	mV
Ripple Rejection	RR	$V_{IN}=27\text{V}$	$I_o=0.5\text{A}$	$E_{in}=2\text{V}_{p-p}$ $f=120\text{Hz}$	53	69	-	dB
Output Noise Voltage	V_{NO}	$V_{IN}=27\text{V}$	$BW=10\text{Hz}$ to 100KHz	$I_o=0.5\text{A}$	-	110	-	μV
Average Temperature Coefficient of Output Voltage	$\Delta V_o / \Delta T$	$V_{IN}=27\text{V}$	$I_o=5\text{mA}$		-	-1	-	$\text{mV}/^{\circ}\text{C}$
ML7820A / ML7820FA								
Output Voltage	V_o	$V_{IN}=29\text{V}$	$I_o=0.5\text{A}$		19.2	20.0	20.8	V
Quiescent Current	I_Q	$V_{IN}=29\text{V}$	$I_o=0\text{mA}$		-	4.5	8.0	mA
Load Regulation	$\Delta V_o / I_o$	$V_{IN}=29\text{V}$	$I_o=0.005\text{A}$ to 1.5A		-	61	400	mV
Line Regulation	$\Delta V_o / V_{in}$	$V_{IN}=23$ to 35V	$I_o=0.5\text{A}$		-	16	400	mV
Ripple Rejection	RR	$V_{IN}=29\text{V}$	$I_o=0.5\text{A}$	$E_{in}=2\text{V}_{p-p}$ $f=120\text{Hz}$	51	66	-	dB
Output Noise Voltage	V_{NO}	$V_{IN}=29\text{V}$	$BW=10\text{Hz}$ to 100KHz	$I_o=0.5\text{A}$	-	150	-	μV
Average Temperature Coefficient of Output Voltage	$\Delta V_o / \Delta T$	$V_{IN}=29\text{V}$	$I_o=5\text{mA}$		-	-2.0	-	$\text{mV}/^{\circ}\text{C}$
ML7824A / ML7824FA								
Output Voltage	V_o	$V_{IN}=33\text{V}$	$I_o=0.5\text{A}$		23.0	24.0	25.0	V
Quiescent Current	I_Q	$V_{IN}=33\text{V}$	$I_o=0\text{mA}$		-	4.6	8.0	mA
Load Regulation	$\Delta V_o / I_o$	$V_{IN}=33\text{V}$	$I_o=0.005\text{A}$ to 1.5A		-	65	480	mV
Line Regulation	$\Delta V_o / V_{in}$	$V_{IN}=28$ to 38V	$I_o=0.5\text{A}$		-	18	480	mV
Ripple Rejection	RR	$V_{IN}=33\text{V}$	$I_o=0.5\text{A}$	$E_{in}=2\text{V}_{p-p}$ $f=120\text{Hz}$	50	66	-	dB
Output Noise Voltage	V_{NO}	$V_{IN}=33\text{V}$	$BW=10\text{Hz}$ to 100KHz	$I_o=0.5\text{A}$	-	170	-	μV
Average Temperature Coefficient of Output Voltage	$\Delta V_o / \Delta T$	$V_{IN}=33\text{V}$	$I_o=5\text{mA}$		-	-2.4	-	$\text{mV}/^{\circ}\text{C}$

REV B

■ Power Dissipation vs. Ambient Temperature

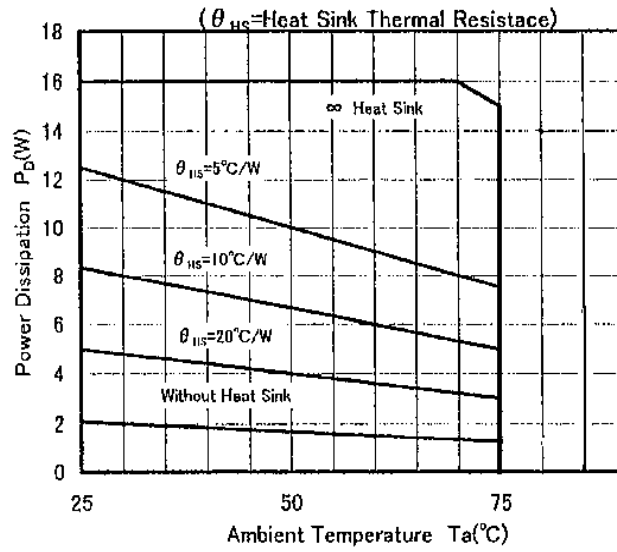

■ Equivalent Circuit

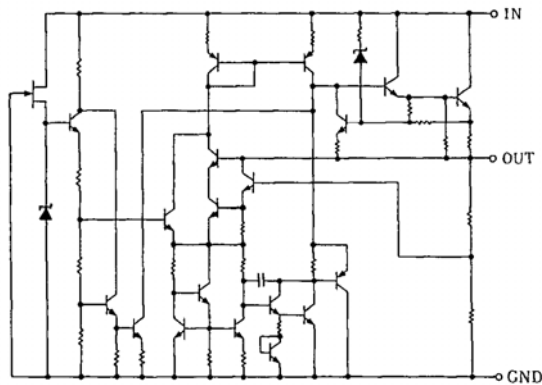

■ Test Circuit

1. Output Voltage, Line Regulation, Load Regulation, Quiescent Current, Average Temperature Coefficient of Output Voltage, Output Noise Voltage.
2. Ripple Rejection

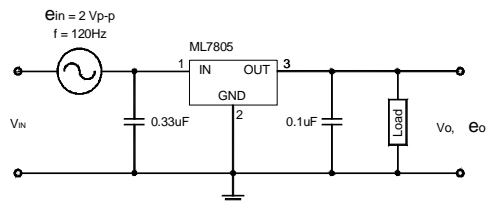
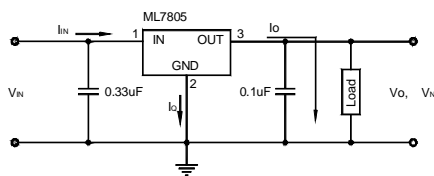

REV B

■ Typical Characteristics

ML7805 / 15 / 24 Output Characteristics

($I_o = 0.5A$, $T_j = 25^\circ C$)

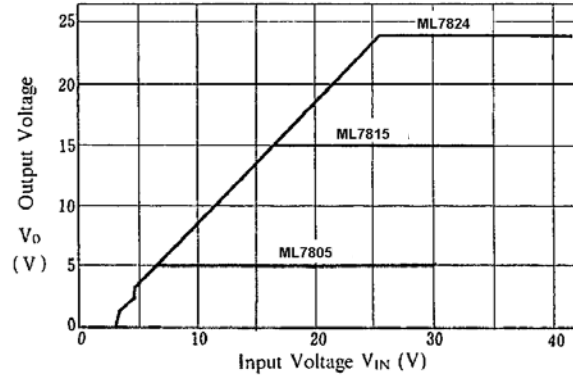

ML7805 Dropout Characteristics

($T_j = 25^\circ C$)

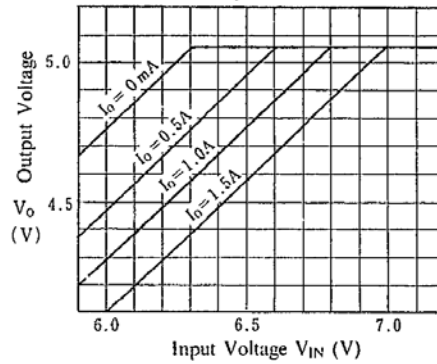

ML7812 Dropout Characteristics

($T_j = 25^\circ C$)

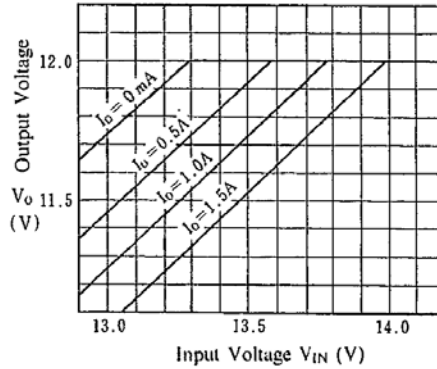

ML7805 / 15 / 24 Load Characteristics

($T_j = 25^\circ C$)

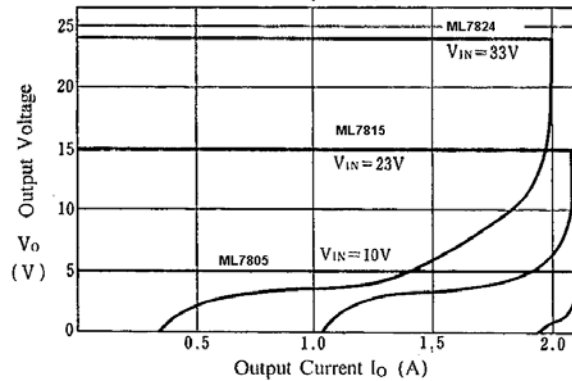

REV B

■ Typical Characteristics

ML7800 Series Short Circuit Output Current
($T_j = 25^\circ\text{C}$, ∞ Heat Sink)

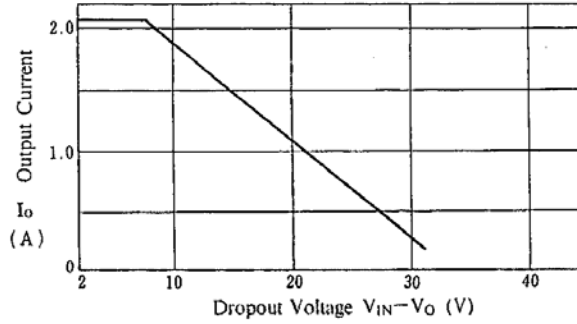

ML7805/24 Quiescent Current vs. Input Voltage
($T_j = 25^\circ\text{C}$)

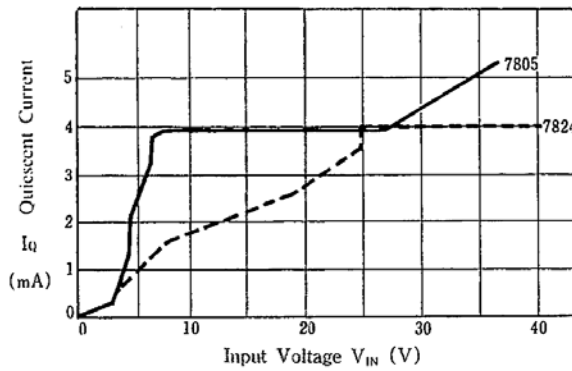

ML7805 /15 /24 Output Voltage vs. Junction Temperature

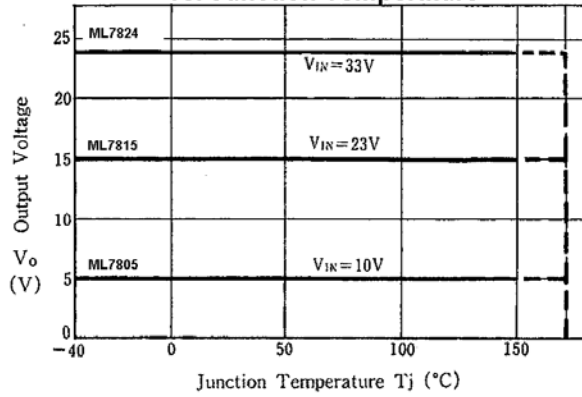

ML7805 /15 /24 Ripple Rejection vs. Frequency

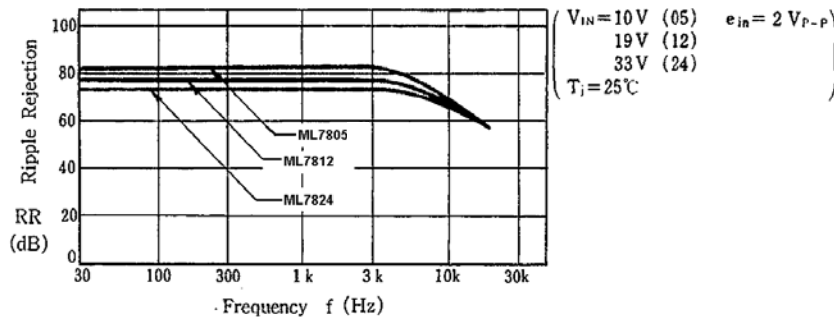

REV B

■ Typical Characteristics

ML7805 Output Voltage vs. Temperature

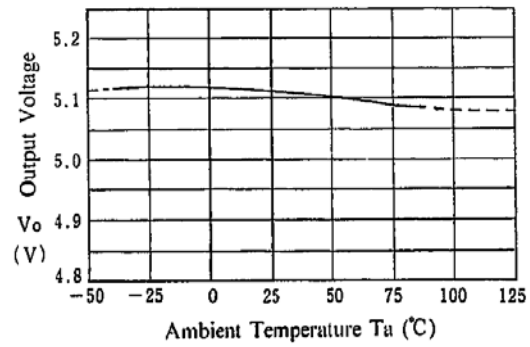

ML7808 Output Voltage vs. Temperature

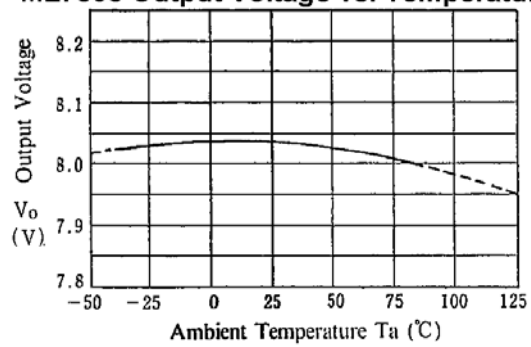

REV B

1. Application Circuit

In the following explain only the positive regulator unless otherwise specified. However they can apply to the negative voltage regulator by easy change.

Positive/Negative Voltage Supply

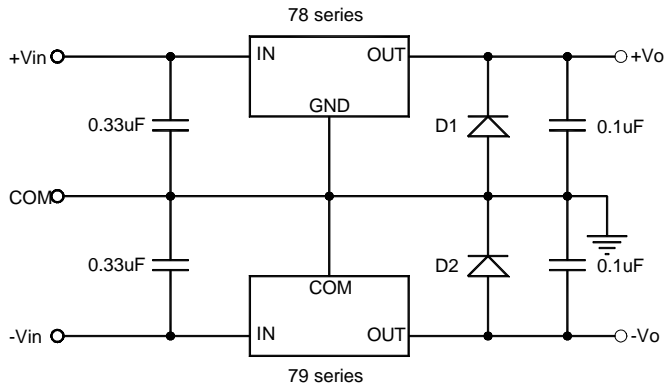

Note : In the above positive and negative power supply application, D1 and D2 should be connected. If D1 and D2 are not connected, either of positive or negative power supply circuit may not turns on.

2. Note in Application Circuit

- (1) If the higher voltage (above the rated value) or lower voltage (GND-0.5V) is supplied to the input terminals, the IC may be destroyed. To avoid such a case, a zener diode or other parts of the surge suppressor should be connected as shown below.

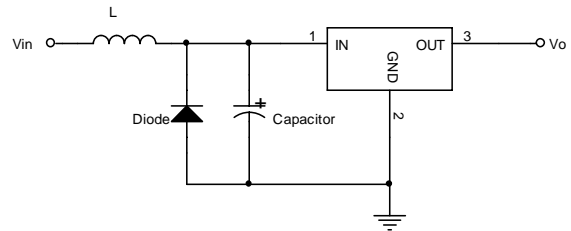
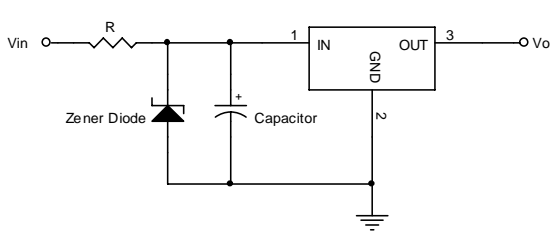

- (2) If the higher voltage than the input terminal is supplied to the output terminal, the IC may be destroyed. To avoid input terminal short to the GND or the stored voltage in the capacitor back to the output terminal, by the large value capacitor connecting to the output terminal application, the SBD should be required as shown below;

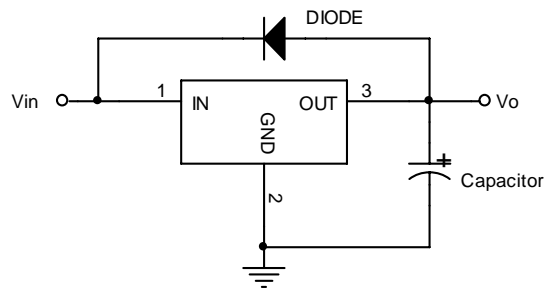

* In case of negative voltage regulator, reverse the SBD and capacitor direction.

REV B

3. Thermal Design

(1) Heat Producing

There are two kinds of heat producing (P_{LOSS-1} , P_{LOSS-2}) in three terminal regulator and the sum of them is total heat producing of IC (P_{LOSS}).

(1-1) P_{LOSS-1} : heat producing by own operation

Input voltage (V_{in}) and quiescent current (I_Q) produce the heat mentioned below equation.

$$P_{LOSS-1} = V_{in} \times I_Q$$

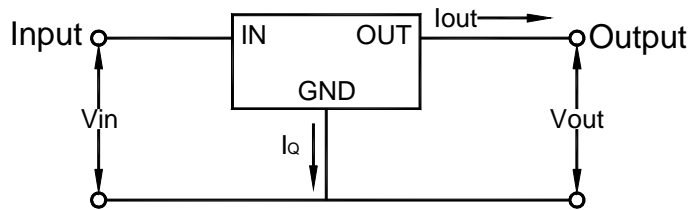

(1-2) P_{LOSS-2} : heat producing by output current and the input-output differential voltage.

Internal power transistor produces the heat mentioned following equation.

$$P_{LOSS-2} = (V_{in} - V_{out}) \times I_{out} \quad (W)$$

Therefore, the total heat producing P_{LOSS} is :

$$\begin{aligned} P_{LOSS} &= P_{LOSS-1} + P_{LOSS-2} \\ &= V_{in} \times I_Q + (V_{in} - V_{out}) \times I_{out} \quad (W) \end{aligned}$$

(2) Thermal Resistance

(2-1) Definition of Thermal Resistance : θ

Thermal resistance (θ) is a degree of heat radiation mentioned following equation.

$$\theta = \frac{T_1 - T_2}{P} \quad (^\circ C / W)$$

Heat Producing Quantity : P (W)
Ambient Temperature or case temperature : T2 ($^\circ C$)
Heat Source Temperature : T1 ($^\circ C$)

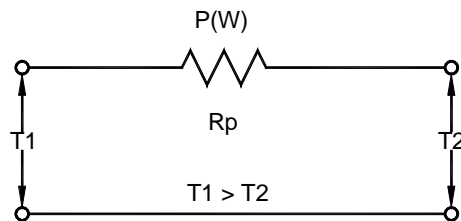

(2-2) Thermal resistance of TO-220

There are two kinds of thermal resistance of TO-220. One is " θ_{jc} " for the application with the heat sink, the other is " θ_{ja} " for the application without the heat sink.

θ_{jc} : thermal resistance between IC chip (junction point) and the package back side contacting with the heat sink.

θ_{ja} : thermal resistance between IC chip (junction point) and ambience.

REV B

(3) Heat Radiation Balance

The heat produced in the IC is radiated to ambience through the package and the heat sink.

The quantity of the heat radiation depends on the heat source temperature, ambient temperature and the thermal resistance of the package.

(3-1) TO-220 with heat sink

Heat radiation balance model of the TO-220 with heat sink is shown as below.

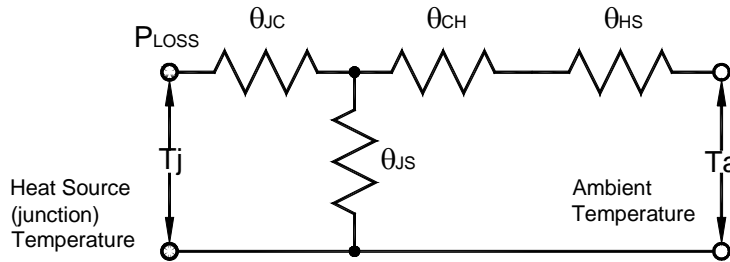

- Where
- θ_{jc} : thermal resistance between IC chip (junction point) and the package backside connecting to the heatsink.
 - θ_{js} : thermal resistance between IC chip (junction point) and the package surface.
 - θ_{ch} : thermal resistance between package backside and the heat sink including the condition of insulator, silicon grease and tighten torque.
 - θ_{hs} : thermal resistance of the heat sink

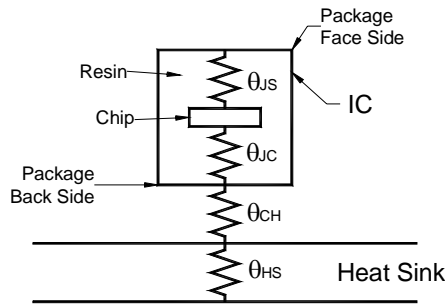

If the θ_{js} is large enough compare with other thermal resistance, the θ_{js} can be neglected and the heat radiation model can be mentioned as below.

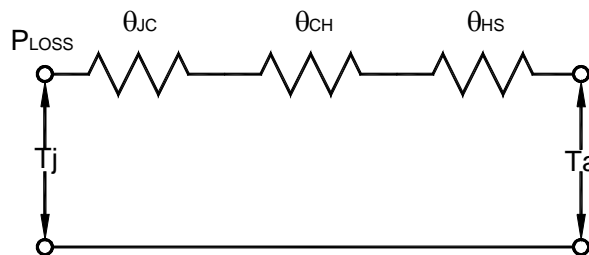

The relation between temperature and heat radiation quantity is shown below.

$$T_j = P_{LOSS} \times (\theta_{jc} + \theta_{ch} + \theta_{hs}) + T_a \quad (^\circ\text{C})$$

REV B

(4) Thermal Design

The heat radiation balance model of the TO-220 with the heat sink is shown as follows.

Heat radiation balance

$$T_j = P_{LOSS} \times (\theta_{jc} + \theta_{ch} + \theta_{hs}) + T_a \quad (^\circ\text{C}) \quad (4-1)$$

$$P_{LOSS} = V_{in} \times I_Q + (V_{in} - V_{out}) \times I_{out} \quad (\text{W}) \quad (4-2)$$

Substituting "Eq.(4-2) into "Eq.(4-1)" obtains

$$T_j = [V_{in} \times I_Q + (V_{in} - V_{out}) \times I_{out}] \times (\theta_{jc} + \theta_{ch} + \theta_{hs}) + T_a \quad (^\circ\text{C}) \quad (4-3)$$

In Eq.(4-3)

V_{in} , I_{out} , θ_{ch} , θ_{hs} , T_a depend on using condition.

T_j , I_Q , V_{out} , θ_{jc} depend on IC specification.

When θ_{ch} , I_Q and T_j are assumed the following values,

Eq.(4-3) becomes Eq.(4-4).

$\theta_{ch} = 0.3$ to 0.4 ($^\circ\text{C}/\text{W}$) Insert the mica paper (0.1t) and thermal conduction silicon grease between the IC and heat sink and tighten them with the bolt by $4\text{Kg}\cdot\text{cm}\cdot\text{min}$.

$I_Q = 5$ to 6mA (max.)

$T_j = 125^\circ\text{C}$ (max.)

$$T_j(\text{max}) = 125 = [5 \times V_{in} + (V_{in} - V_{out}) \times I_{out}] \times (5 + 0.3 + \theta_{hs}) + T_a \quad (^\circ\text{C}) \quad (4-4)$$

When fix the V_{out} , T_j depends on the V_{in} , I_{out} , θ_{hs} and T_a .

It means;

Lower V_{in} and / or I_{out} are required to limit the temperature rise.

Smaller θ_{hs} is required for the effective heat reduce (i.e. using the large heat sink).

In the thermal design, when fix the V_{in} , I_{out} and T_a , select the heat sink which θ_{hs} is smaller than the result of Eq.(4-4).

For more detail, please refer the heat resistance value mentioned in the specification of the heat sink supplier.