

International
IR Rectifier

IRGIB7B60KDPbF

INSULATED GATE BIPOLAR TRANSISTOR WITH
ULTRAFAST SOFT RECOVERY DIODE

Features

- Low VCE (on) Non Punch Through IGBT Technology.
- 10 μ s Short Circuit Capability.
- Square RBSOA.
- Positive VCE (on) Temperature Coefficient.
- Maximum Junction Temperature rated at 175°C.
- Lead-Free

Benefits

- Benchmark Efficiency for Motor Control.
- Rugged Transient Performance.
- Low EMI.
- Excellent Current Sharing in Parallel Operation.

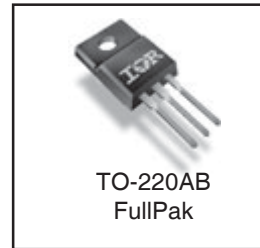
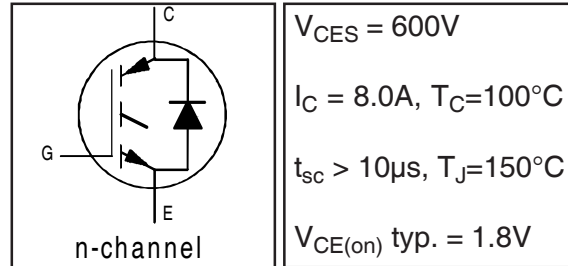

Absolute Maximum Ratings

	Parameter	Max.	Units
V_{CES}	Collector-to-Emitter Voltage	600	V
$I_C @ T_C = 25^\circ C$	Continuous Collector Current	12	A
$I_C @ T_C = 100^\circ C$	Continuous Collector Current	8.0	
I_{CM}	Pulse Collector Current (Ref.Fig.C.T.5)	24	
I_{LM}	Clamped Inductive Load current ①	24	
$I_F @ T_C = 25^\circ C$	Diode Continuous Forward Current	9.0	
$I_F @ T_C = 100^\circ C$	Diode Continuous Forward Current	6.0	
I_{FM}	Diode Maximum Forward Current	18	V
V_{ISOL}	RMS Isolation Voltage, Terminal to Case, t=1 min.	2500	
V_{GE}	Gate-to-Emitter Voltage	± 20	W
$P_D @ T_C = 25^\circ C$	Maximum Power Dissipation	39	
$P_D @ T_C = 100^\circ C$	Maximum Power Dissipation	20	$^\circ C$
T_J	Operating Junction and	-55 to +175	
T_{STG}	Storage Temperature Range		
	Soldering Temperature, for 10 sec.	300 (0.063 in. (1.6mm) from case)	
	Mounting Torque, 6-32 or M3 Screw	10 lbf-in (1.1 N·m)	

Thermal / Mechanical Characteristics

	Parameter	Min.	Typ.	Max.	Units
$R_{\theta JC}$	Junction-to-Case- IGBT	—	—	3.8	$^\circ C/W$
$R_{\theta JC}$	Junction-to-Case- Diode	—	—	6.0	
$R_{\theta CS}$	Case-to-Sink, flat, greased surface	—	0.50	—	
$R_{\theta JA}$	Junction-to-Ambient, typical socket mount	—	—	62	
Wt	Weight	—	2.0	—	g

IRGIB7B60KDPbF

International
IR RectifierElectrical Characteristics @ $T_J = 25^\circ\text{C}$ (unless otherwise specified)

	Parameter	Min.	Typ.	Max.	Units	Conditions	Ref.Fig.
$V_{(BR)CES}$	Collector-to-Emitter Breakdown Voltage	600	—	—	V	$V_{GE} = 0V, I_C = 500\mu A$	
$\Delta V_{(BR)CES}/\Delta T_J$	Temperature Coeff. of Breakdown Voltage	—	0.57	—	V/°C	$V_{GE} = 0V, I_C = 1mA (25^\circ\text{C}-150^\circ\text{C})$	
$V_{CE(on)}$	Collector-to-Emitter Voltage	—	1.8	2.2	V	$I_C = 8.0A, V_{GE} = 15V, T_J = 25^\circ\text{C}$	5,6,7
		—	2.2	2.5		$I_C = 8.0A, V_{GE} = 15V, T_J = 150^\circ\text{C}$	9,10,11
		—	2.3	2.5		$I_C = 8.0A, V_{GE} = 15V, T_J = 175^\circ\text{C}$	
$V_{GE(th)}$	Gate Threshold Voltage	3.5	4.5	5.5	V	$V_{CE} = V_{GE}, I_C = 250\mu A$	9,10,11
$\Delta V_{GE(th)}/\Delta T_J$	Threshold Voltage temp. coefficient	—	-9.5	—	mV/°C	$V_{CE} = V_{GE}, I_C = 1mA (25^\circ\text{C}-150^\circ\text{C})$	12
gfe	Forward Transconductance	—	3.7	—	S	$V_{CE} = 50V, I_C = 8.0A, PW = 80\mu s$	
I_{CES}	Zero Gate Voltage Collector Current	—	1.0	150	μA	$V_{GE} = 0V, V_{CE} = 600V$	
		—	200	500		$V_{GE} = 0V, V_{CE} = 600V, T_J = 150^\circ\text{C}$	
		—	720	1100		$V_{GE} = 0V, V_{CE} = 600V, T_J = 175^\circ\text{C}$	
V_{FM}	Diode Forward Voltage Drop	—	1.25	1.45	V	$I_F = 5.0A, V_{GE} = 0V$	8
		—	1.20	1.40		$I_F = 5.0A, T_J = 150^\circ\text{C}, V_{GE} = 0V$	
		—	1.20	1.30		$I_F = 5.0A, T_J = 175^\circ\text{C}, V_{GE} = 0V$	
I_{GES}	Gate-to-Emitter Leakage Current	—	—	± 100	nA	$V_{GE} = \pm 20V, V_{CE} = 0V$	

Switching Characteristics @ $T_J = 25^\circ\text{C}$ (unless otherwise specified)

	Parameter	Min.	Typ.	Max.	Units	Conditions	Ref.Fig.
Q_g	Total Gate Charge (turn-on)	—	29	44	nC	$I_C = 8.0A$	23
Q_{ge}	Gate-to-Emitter Charge (turn-on)	—	3.7	5.6		$V_{CC} = 400V$	CT1
Q_{gc}	Gate-to-Collector Charge (turn-on)	—	14	21		$V_{GE} = 15V$	
E_{on}	Turn-On Switching Loss	—	160	268	μJ	$I_C = 8.0A, V_{CC} = 400V$	CT4
E_{off}	Turn-Off Switching Loss	—	160	268		$V_{GE} = 15V, R_G = 50\Omega, L = 1.1mH$	
E_{tot}	Total Switching Loss	—	320	433		$T_J = 25^\circ\text{C} \text{ @}$	
$t_{d(on)}$	Turn-On delay time	—	23	27	ns	$I_C = 8.0A, V_{CC} = 400V$	CT4
t_r	Rise time	—	22	26		$V_{GE} = 15V, R_G = 50\Omega, L = 1.1mH$	
$t_{d(off)}$	Turn-Off delay time	—	140	150		$T_J = 25^\circ\text{C}$	
t_f	Fall time	—	32	42			
E_{on}	Turn-On Switching Loss	—	220	330		$I_C = 8.0A, V_{CC} = 400V$	
E_{off}	Turn-Off Switching Loss	—	270	381	μJ	$V_{GE} = 15V, R_G = 50\Omega, L = 1.1mH$	13,15
E_{tot}	Total Switching Loss	—	490	711		$T_J = 150^\circ\text{C} \text{ @}$	WF1,WF2
$t_{d(on)}$	Turn-On delay time	—	22	27		$I_C = 8.0A, V_{CC} = 400V$	14,16
t_r	Rise time	—	21	25	ns	$V_{GE} = 15V, R_G = 50\Omega, L = 1.1mH$	CT4
$t_{d(off)}$	Turn-Off delay time	—	180	198		$T_J = 150^\circ\text{C}$	WF1
t_f	Fall time	—	40	56			WF2
L_E	Internal Emitter Inductance	—	7.5	—	nH	Measured 5mm from package	
C_{ies}	Input Capacitance	—	440	660	pF	$V_{GE} = 0V$	22
C_{oes}	Output Capacitance	—	38	57		$V_{CC} = 30V$	
C_{res}	Reverse Transfer Capacitance	—	16	24		$f = 1.0MHz$	
RBSOA	Reverse Bias Safe Operating Area	FULL SQUARE				$T_J = 150^\circ\text{C}, I_C = 54A, V_p = 600V$ $V_{CC}=500V, V_{GE} = +15V \text{ to } 0V, R_G = 50\Omega$	4 CT2
SCSOA	Short Circuit Safe Operating Area	10	—	—	μs	$T_J = 150^\circ\text{C}, V_p = 600V, R_G = 100\Omega$ $V_{CC}=360V, V_{GE} = +15V \text{ to } 0V$	CT3 WF4
$I_{SC}(\text{Peak})$	Peak Short Circuit Collector Current	—	70	—	A		WF4
E_{rec}	Reverse Recovery Energy of the Diode	—	100	133	μJ	$T_J = 150^\circ\text{C}$	17,18,19
t_{rr}	Diode Reverse Recovery Time	—	95	120	ns	$V_{CC} = 400V, I_F = 8.0A, L = 1.07mH$	20,21
I_{rr}	Peak Reverse Recovery Current	—	13	17	A	$V_{GE} = 15V, R_G = 50\Omega$	CT4,WF3
Q_{rr}	Diode Reverse Recovery Charge	—	620	800	nC	$di/dt = 500A/\mu s$	

Note ① to ② are on page 12

2

www.irf.com

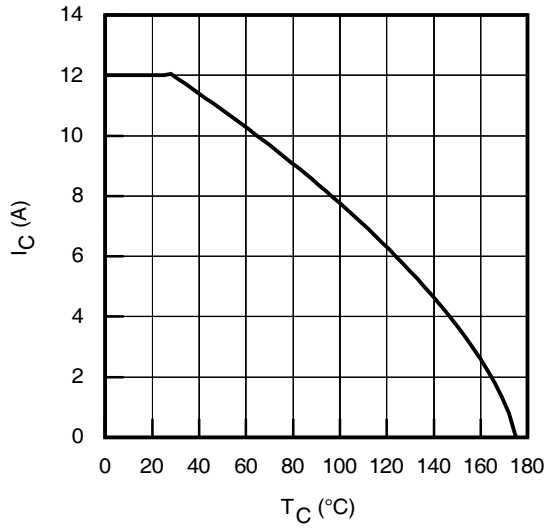

Fig. 1 - Maximum DC Collector Current vs. Case Temperature

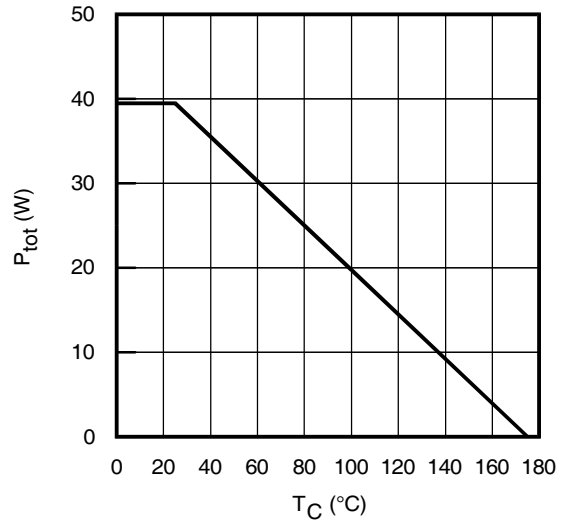

Fig. 2 - Power Dissipation vs. Case Temperature

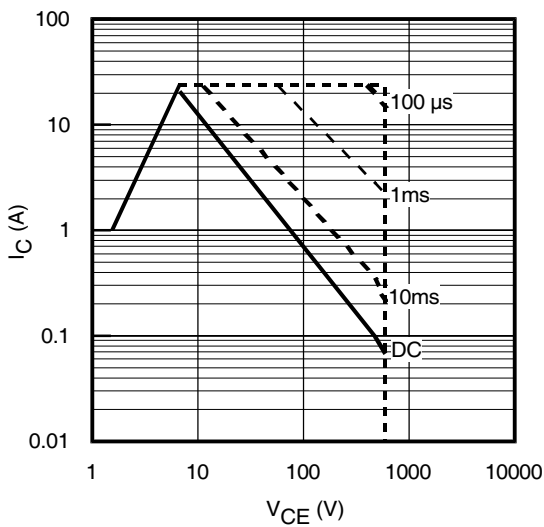

Fig. 3 - Forward SOA
 T_C = 25°C; T_J ≤ 150°C

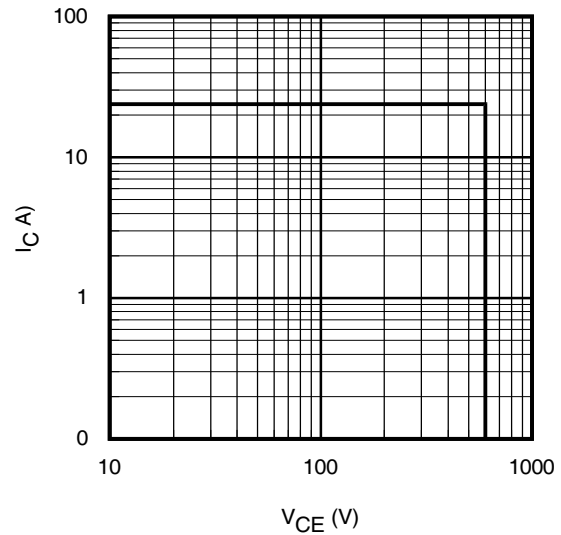

Fig. 4 - Reverse Bias SOA
 T_J = 150°C; V_{GE} = 15V

IRGIB7B60KDPbF

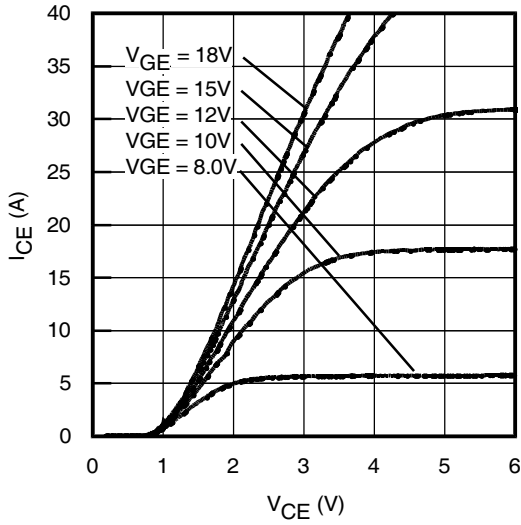

Fig. 5 - Typ. IGBT Output Characteristics
 $T_J = -40^\circ\text{C}$; $t_p = 80\mu\text{s}$

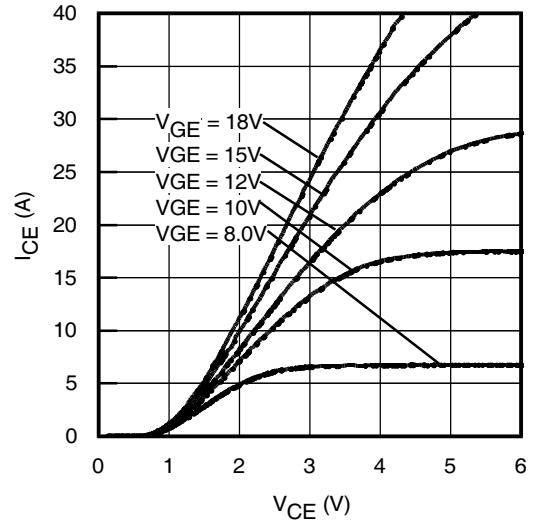

Fig. 6 - Typ. IGBT Output Characteristics
 $T_J = 25^\circ\text{C}$; $t_p = 80\mu\text{s}$

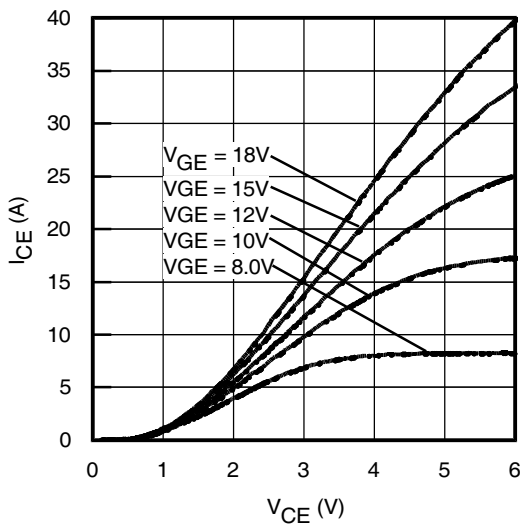

Fig. 7 - Typ. IGBT Output Characteristics
 $T_J = 150^\circ\text{C}$; $t_p = 80\mu\text{s}$

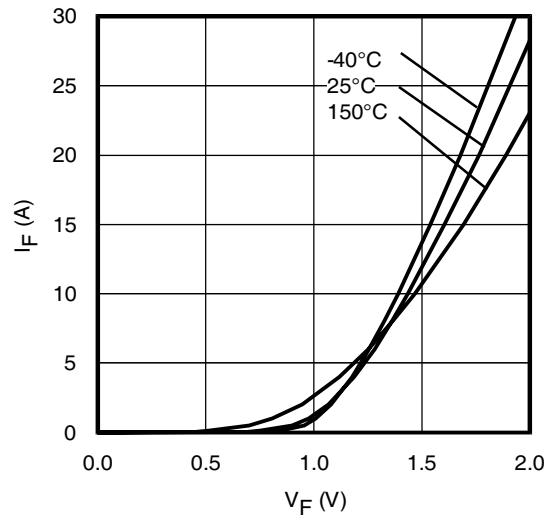

Fig. 8 - Typ. Diode Forward Characteristics
 $t_p = 80\mu\text{s}$

IRGIB7B60KDPbF

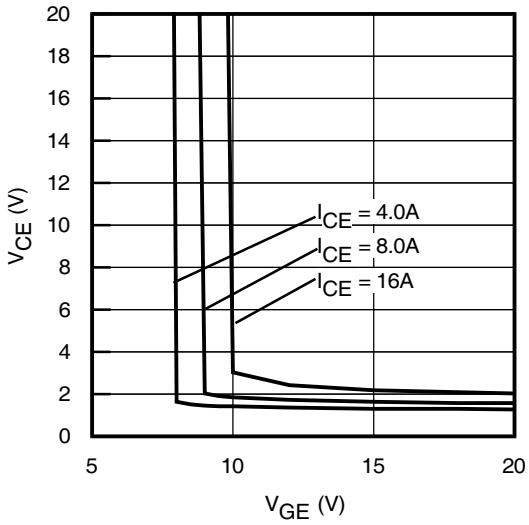

Fig. 9 - Typical V_{CE} vs. V_{GE}
 $T_J = -40^\circ\text{C}$

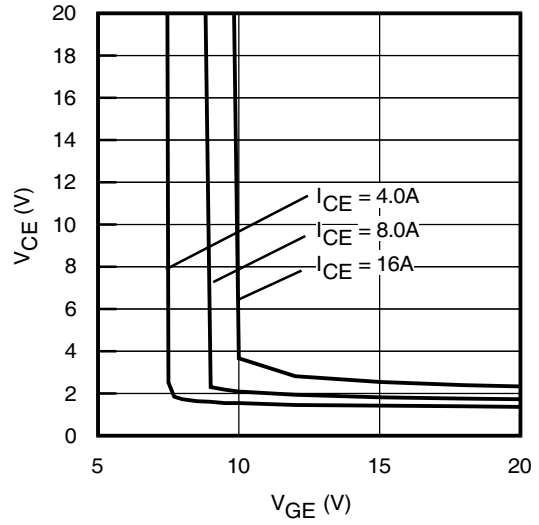

Fig. 10 - Typical V_{CE} vs. V_{GE}
 $T_J = 25^\circ\text{C}$

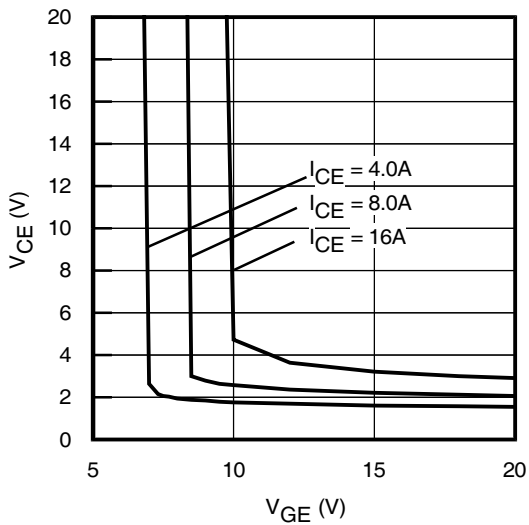

Fig. 11 - Typical V_{CE} vs. V_{GE}
 $T_J = 150^\circ\text{C}$

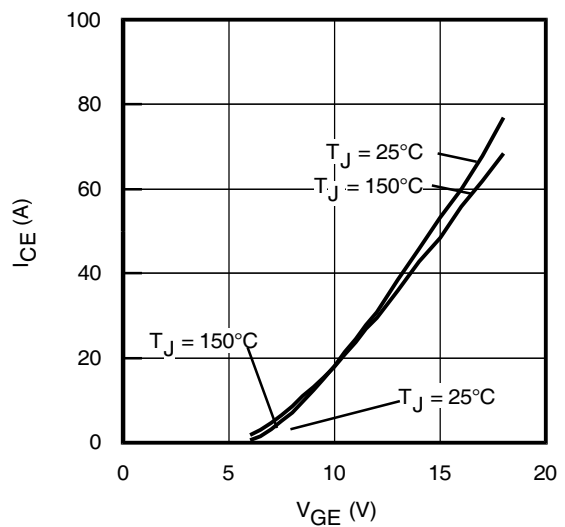

Fig. 12 - Typ. Transfer Characteristics
 $V_{CE} = 360\text{V}$; $t_p = 10\mu\text{s}$

IRGIB7B60KDPbF

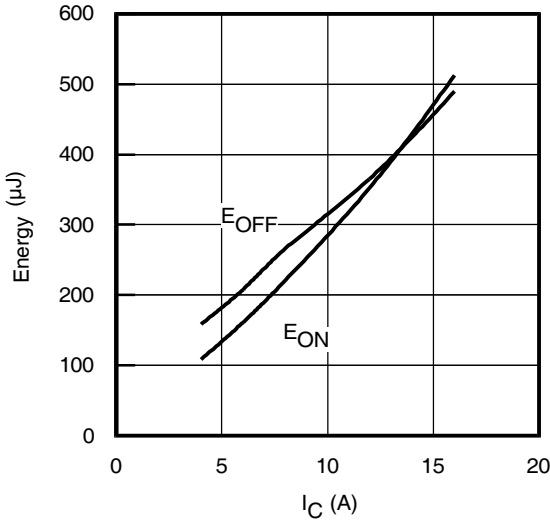

Fig. 13 - Typ. Energy Loss vs. I_C
 $T_J = 150^\circ\text{C}$; $L=1.1\text{mH}$; $V_{CE}= 400\text{V}$,
 $R_G= 50\Omega$; $V_{GE}= 15\text{V}$

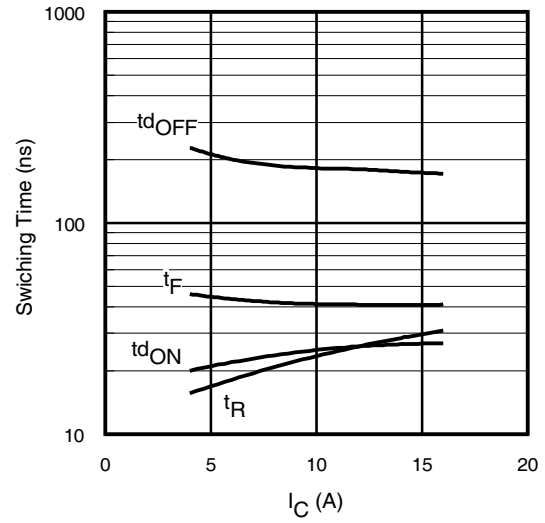

Fig. 14 - Typ. Switching Time vs. I_C
 $T_J = 150^\circ\text{C}$; $L=1.1\text{mH}$; $V_{CE}= 400\text{V}$
 $R_G= 50\Omega$; $V_{GE}= 15\text{V}$

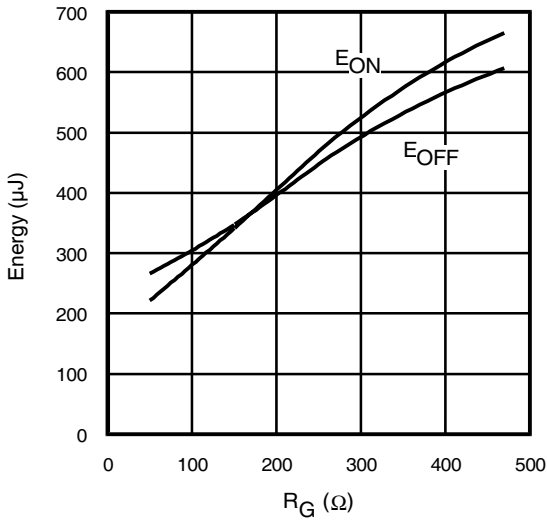

Fig. 15 - Typ. Energy Loss vs. R_G
 $T_J = 150^\circ\text{C}$; $L=1.1\text{mH}$; $V_{CE}= 400\text{V}$
 $I_{CE}= 8.0\text{A}$; $V_{GE}= 15\text{V}$

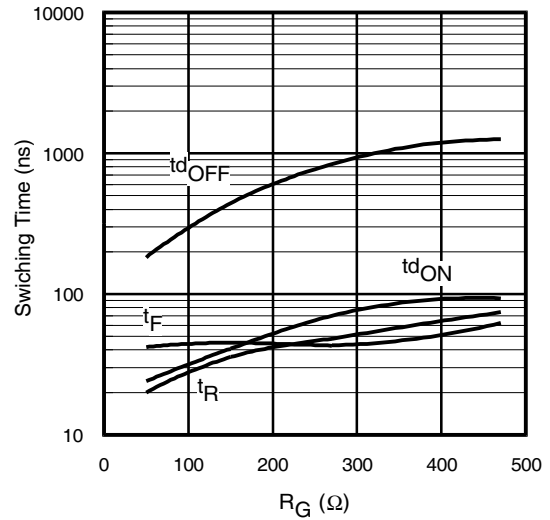

Fig. 16 - Typ. Switching Time vs. R_G
 $T_J = 150^\circ\text{C}$; $L=1.1\text{mH}$; $V_{CE}= 400\text{V}$
 $I_{CE}= 8.0\text{A}$; $V_{GE}= 15\text{V}$

IRGIB7B60KDPbF

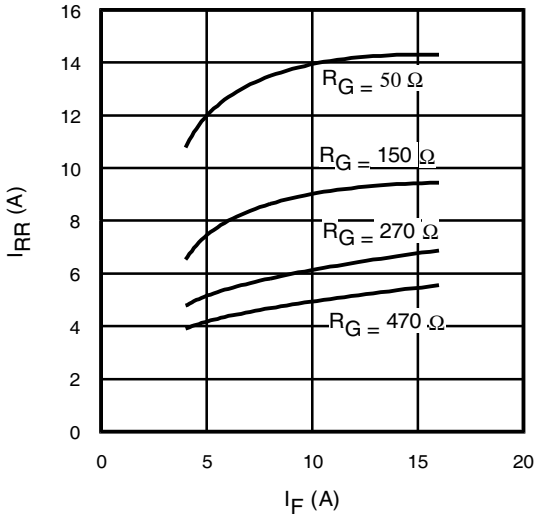

Fig. 17 - Typical Diode I_{RR} vs. I_F
 $T_J = 150^\circ\text{C}$

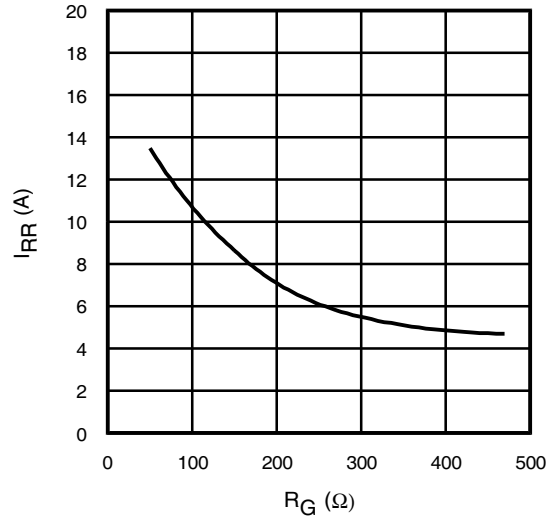

Fig. 18 - Typical Diode I_{RR} vs. R_G
 $T_J = 150^\circ\text{C}$; $I_F = 8.0\text{A}$

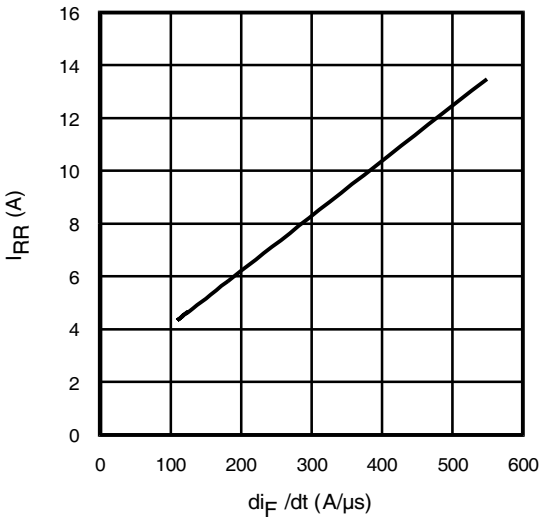

Fig. 19- Typical Diode I_{RR} vs. di_F/dt
 $V_{CC} = 400\text{V}$; $V_{GE} = 15\text{V}$;
 $I_F = 8.0\text{A}$; $T_J = 150^\circ\text{C}$

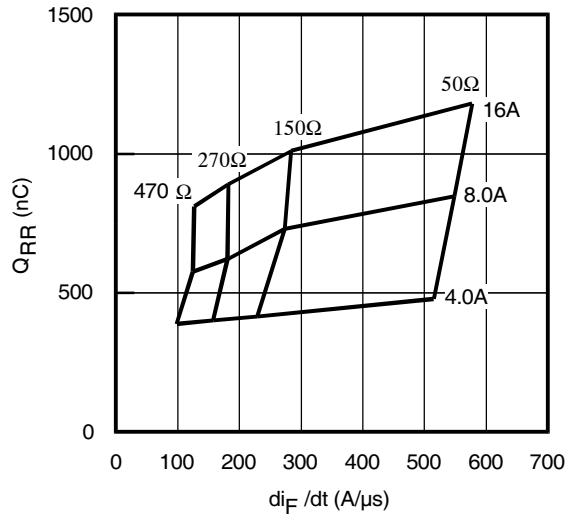

Fig. 20 - Typical Diode Q_{RR}
 $V_{CC} = 400\text{V}$; $V_{GE} = 15\text{V}$; $T_J = 150^\circ\text{C}$

IRGIB7B60KDPbF

International
IR Rectifier

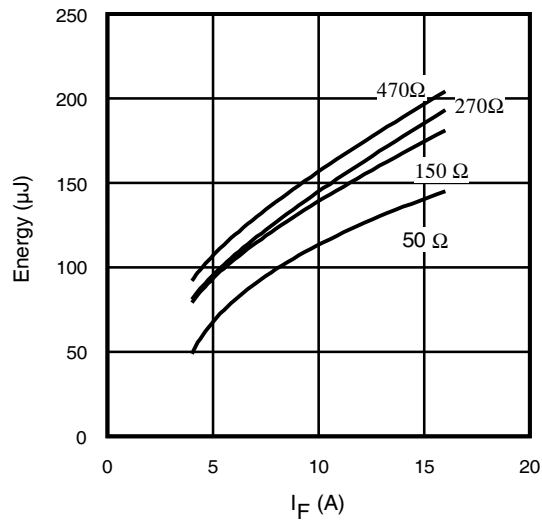

Fig. 21 - Typical Diode E_{RR} vs. I_F
 $T_J = 150^\circ\text{C}$

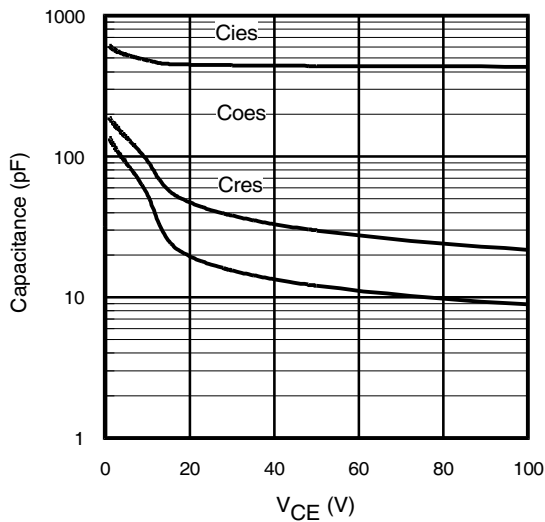

Fig. 22- Typ. Capacitance vs. V_{CE}
 $V_{GE} = 0\text{V}$; $f = 1\text{MHz}$

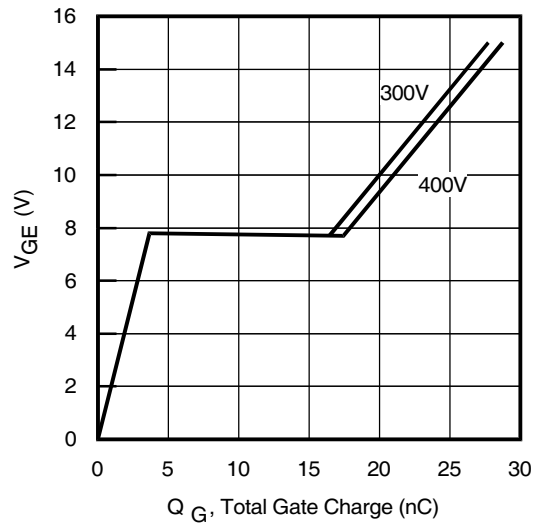

Fig. 23 - Typical Gate Charge vs. V_{GE}
 $I_{CE} = 8.0\text{A}$; $L = 600\mu\text{H}$

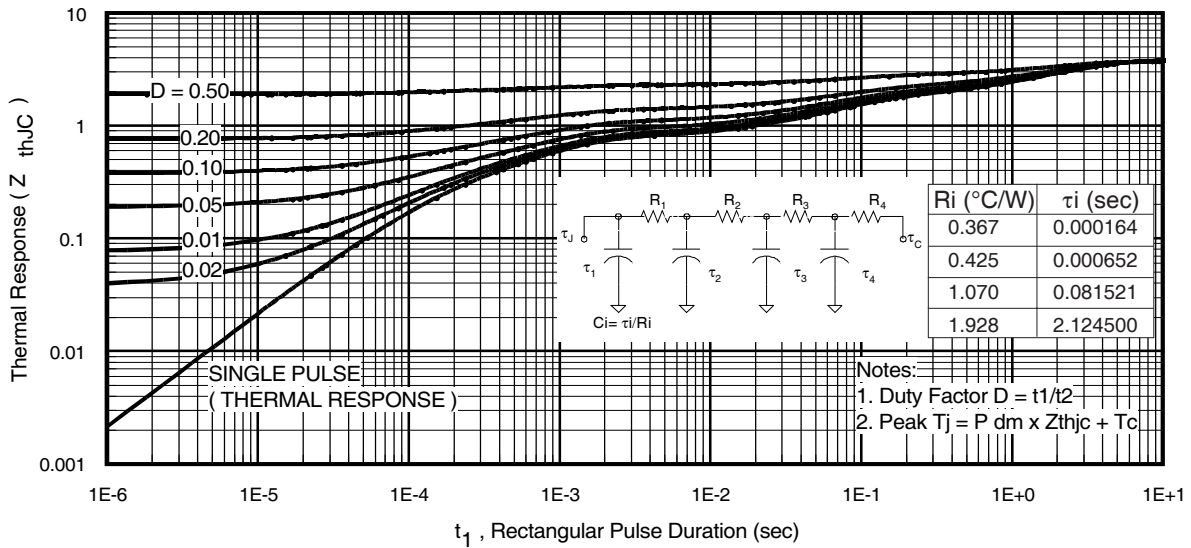

Fig 24. Maximum Transient Thermal Impedance, Junction-to-Case (IGBT)

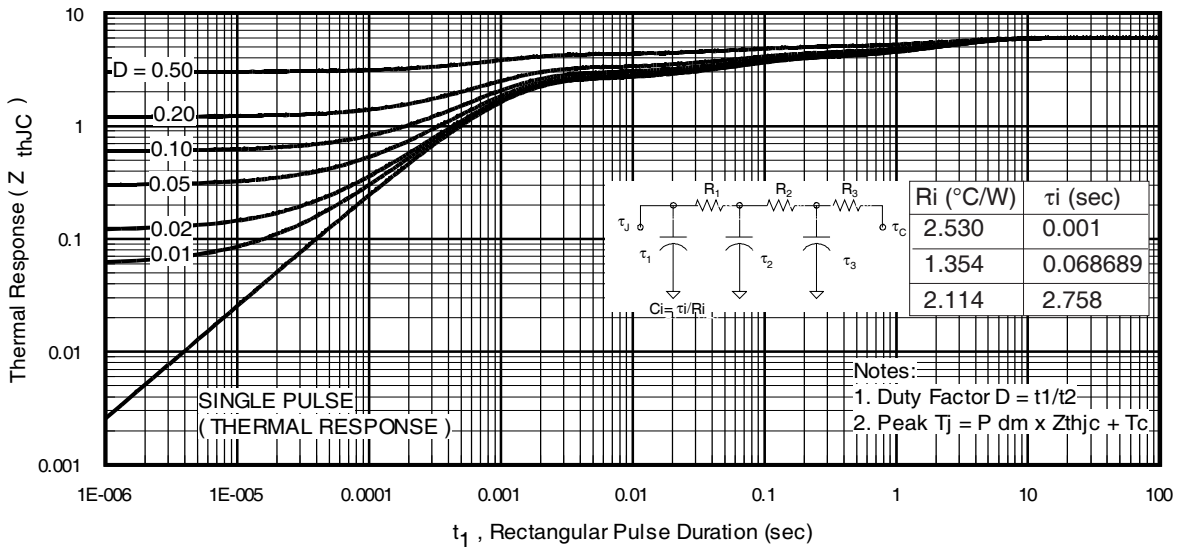

Fig 25. Maximum Transient Thermal Impedance, Junction-to-Case (DIODE)

IRGIB7B60KDPbF

International
IR Rectifier

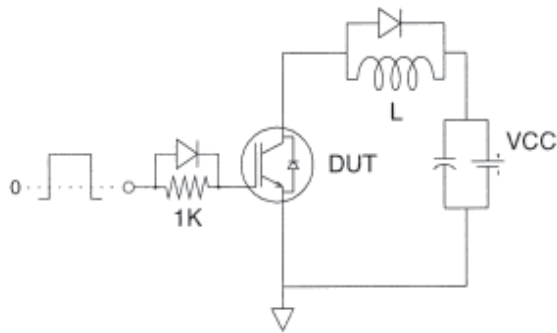

Fig.C.T.1 - Gate Charge Circuit (turn-off)

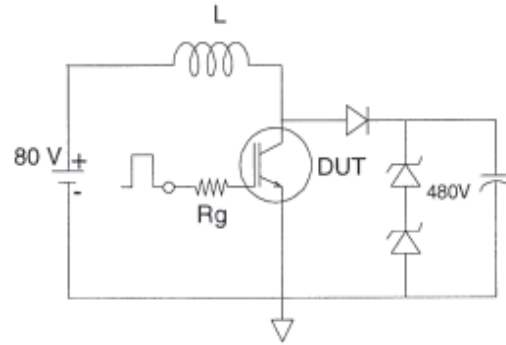

Fig.C.T.2 - RBSOA Circuit

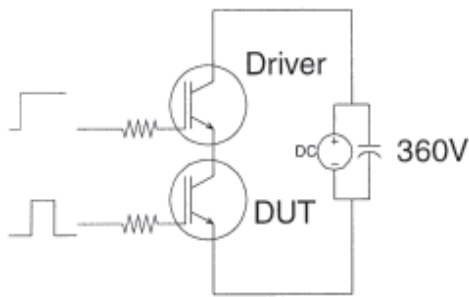

Fig.C.T.3 - S.C.SOA Circuit

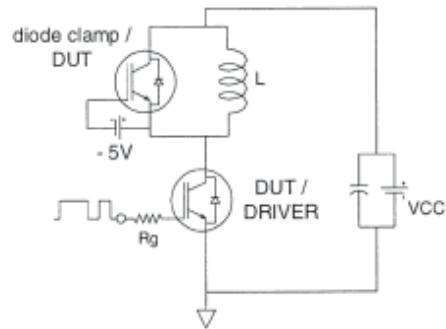

Fig.C.T.4 - Switching Loss Circuit

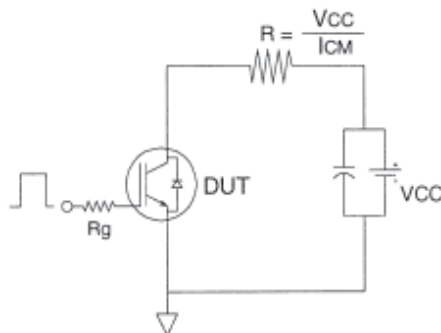

Fig.C.T.5 - Resistive Load Circuit

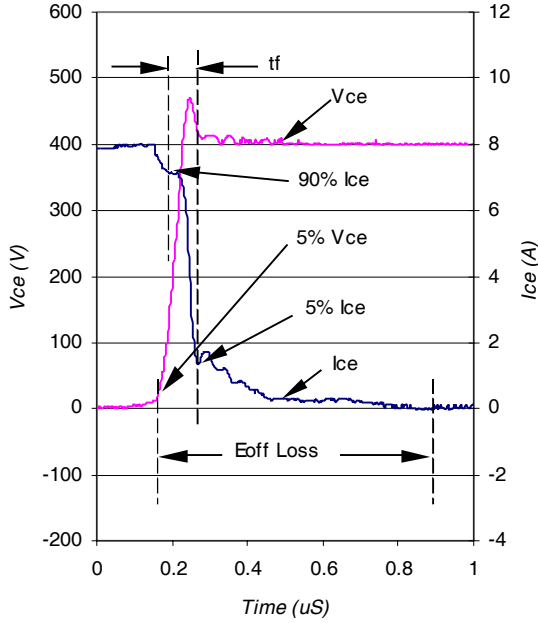

Fig. WF1- Typ. Turn-off Loss Waveform
@ T_J = 150°C using Fig. CT.4

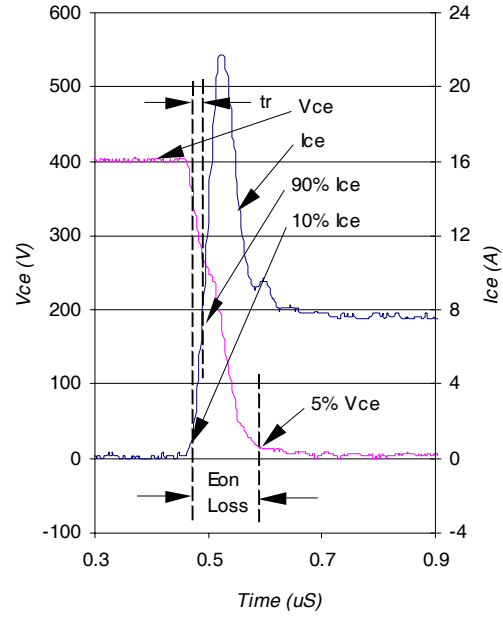

Fig. WF2- Typ. Turn-on Loss Waveform
@ T_J = 150°C using Fig. CT.4

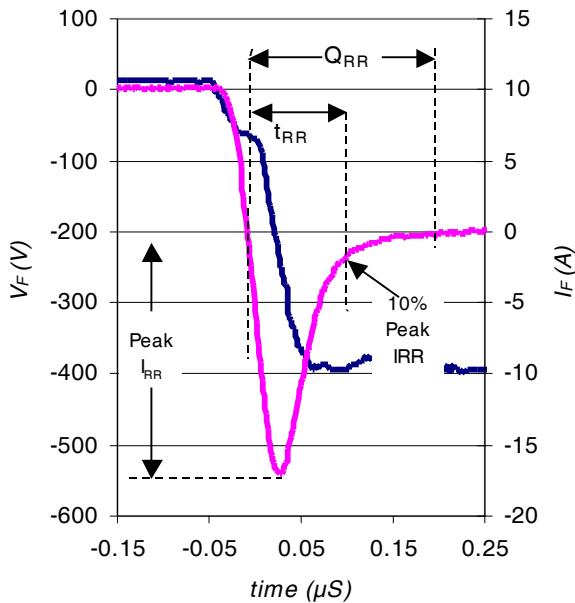

Fig. WF3- Typ. Diode Recovery Waveform
@ T_J = 150°C using Fig. CT.4

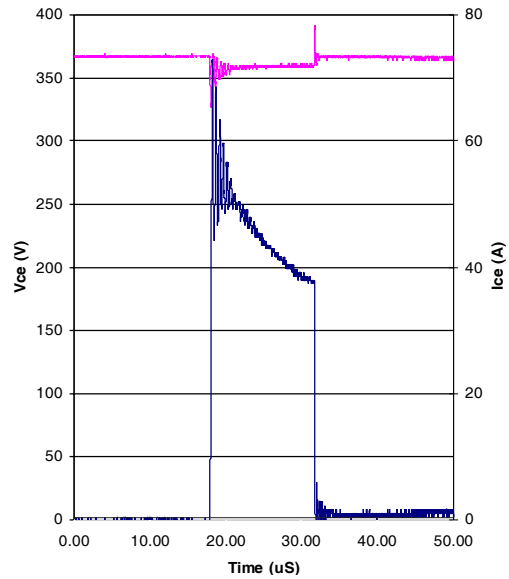
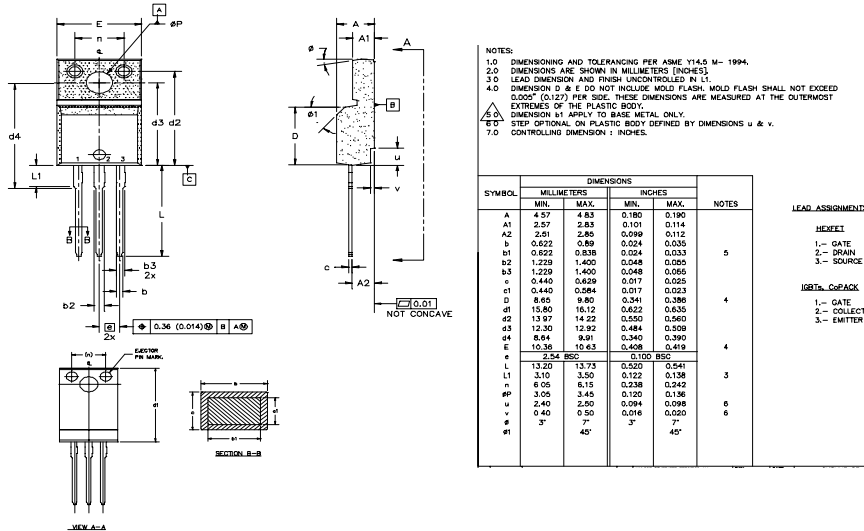

Fig. WF4- Typ. S.C Waveform
@ T_C = 150°C using Fig. CT.3

IRGIB7B60KDPbF

TO-220 Full-Pak Package Outline

Dimensions are shown in millimeters (inches)



TO-220 Full-Pak Part Marking Information

EXAMPLE: THIS IS AN IRF1840G
 WITH ASSEMBLY
 LOT CODE 3432
 ASSEMBLED ON WW 24 1999
 IN THE ASSEMBLY LINE "K"
Note: "P" in assembly line
 position indicates "Lead-Free"

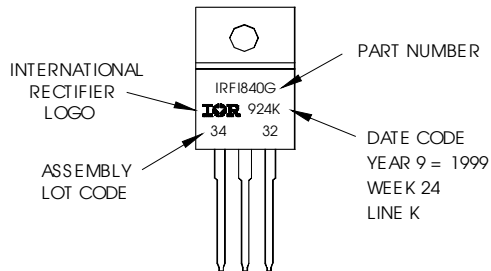

Notes:

- ① $V_{CC} = 80\% (V_{CES})$, $V_{GE} = 15V$, $L = 100\mu H$, $R_G = 50\Omega$.
- ② Energy losses include "tail" and diode reverse recovery.

TO-220AB FullPak package is not recommended for Surface Mount Application.

Data and specifications subject to change without notice.
 This product has been designed and qualified for Industrial market.
 Qualification Standards can be found on IR's Web site.



IR WORLD HEADQUARTERS: 233 Kansas St., El Segundo, California 90245, USA Tel: (310) 252-7105
 TAC Fax: (310) 252-7903
 Visit us at www.irf.com for sales contact information.04/04