

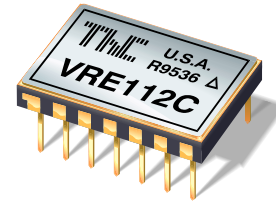

# VRE110/111/112

## Precision Reference Supplies



THALER CORPORATION • 2015 N. FORBES BOULEVARD • TUCSON, AZ. 85745 • (520) 882-4000

### FEATURES

- **VERY HIGH ACCURACY:** 2.500 V OUTPUT  $\pm 200 \mu\text{V}$
- **EXTREMELY LOW DRIFT:** 0.8 ppm/ $^{\circ}\text{C}$  55 $^{\circ}\text{C}$  to +125 $^{\circ}\text{C}$
- **LOW WARM-UP DRIFT:** 1 ppm Typ.
- **EXCELLENT STABILITY:** 6 ppm/1000 Hrs. Typ.
- **EXCELLENT LINE REGULATION:** 3 ppm/V Typ.
- **HERMETIC 14-PIN CERAMIC DIP**
- **MILITARY PROCESSING OPTION**

### APPLICATIONS

- **PRECISION A/D and D/A CONVERTERS**
- **TRANSDUCER EXCITATION**
- **ACCURATE COMPARATOR THRESHOLD REFERENCE**
- **HIGH RESOLUTION SERVO SYSTEMS**
- **DIGITAL VOLTMETERS**
- **HIGH PRECISION TEST AND MEASUREMENT INSTRUMENTS**

### DESCRIPTION

VRE110 Series Precision Voltage References provide ultrastable +2.500V (VRE110), -2.500V (VRE101) and  $\pm 2.500\text{V}$  (VRE102) outputs with  $\pm 200 \mu\text{V}$  initial accuracy and temperature coefficient as low as 0.8 ppm/ $^{\circ}\text{C}$  over the full military temperature range. This improvement in accuracy is made possible by a unique, proprietary multipoint laser compensation technique developed by Thaler Corporation. Significant improvements have been made in other performance parameters as well, including initial accuracy, warm-up drift, line regulation, and long-term stability, making the VRE110 series the most accurate and stable 2.5V reference available.

VRE110/111/112 devices are available in two operating temperature ranges, -25 $^{\circ}\text{C}$  to +85 $^{\circ}\text{C}$  and -55 $^{\circ}\text{C}$  to +125 $^{\circ}\text{C}$ , and two performance grades. All devices are packaged in 14-pin hermetic ceramic packages for maximum long-term stability. "M" versions are screened for high reliability and quality.

Superior stability, accuracy, and quality make these references ideal for precision applications such as A/D and D/A converters, high-accuracy test and measurement instrumentation, and transducer excitation.

### SELECTION GUIDE

Type	Output	Temperature Operating Range	Max. Volt Deviation
VRE110C	+2.5V	-25 $^{\circ}\text{C}$ to +85 $^{\circ}\text{C}$	200 $\mu\text{V}$
VRE110CA	+2.5V	-25 $^{\circ}\text{C}$ to +85 $^{\circ}\text{C}$	100 $\mu\text{V}$
VRE110M	+2.5V	-55 $^{\circ}\text{C}$ to +125 $^{\circ}\text{C}$	400 $\mu\text{V}$
VRE110MA	+2.5V	-55 $^{\circ}\text{C}$ to +125 $^{\circ}\text{C}$	200 $\mu\text{V}$
VRE111C	-2.5V	-25 $^{\circ}\text{C}$ to +85 $^{\circ}\text{C}$	200 $\mu\text{V}$
VRE111CA	-2.5V	-25 $^{\circ}\text{C}$ to +85 $^{\circ}\text{C}$	100 $\mu\text{V}$
VRE111M	-2.5V	-55 $^{\circ}\text{C}$ to +125 $^{\circ}\text{C}$	400 $\mu\text{V}$
VRE111MA	-2.5V	-55 $^{\circ}\text{C}$ to +125 $^{\circ}\text{C}$	200 $\mu\text{V}$
VRE112C	$\pm 2.5\text{V}$	-25 $^{\circ}\text{C}$ to +85 $^{\circ}\text{C}$	200 $\mu\text{V}$
VRE112CA	$\pm 2.5\text{V}$	-25 $^{\circ}\text{C}$ to +85 $^{\circ}\text{C}$	100 $\mu\text{V}$
VRE112M	$\pm 2.5\text{V}$	-55 $^{\circ}\text{C}$ to +125 $^{\circ}\text{C}$	400 $\mu\text{V}$
VRE112MA	$\pm 2.5\text{V}$	-55 $^{\circ}\text{C}$ to +125 $^{\circ}\text{C}$	200 $\mu\text{V}$

# ELECTRICAL SPECIFICATIONS

VRE110/111/112

Vps = ±15V, T = 25°C, RL = 10kΩ unless otherwise noted.

MODEL	C			CA			M			MA			
PARAMETERS	MIN	TYP	MAX	MIN	TYP	MAX	MIN	TYP	MAX	MIN	TYP	MAX	UNITS
<b>ABSOLUTE MAXIMUM RATINGS</b>													
Power Supply	±13.5		±22	*		*	*		*	*		*	V
Operating Temperature	-25		85	*		*	-55		125	-55		125	°C
Storage Temperature	-65		150	*		*	*		*	*		*	°C
Short Circuit Protection	Continuous				*			*			*		
<b>OUTPUT VOLTAGE</b>													
VRE110		+2.5			*			*			*		V
VRE111		-2.5			*			*			*		V
VRE112		±2.5			*			*			*		V
<b>OUTPUT VOLTAGE ERRORS</b>													
Initial Error			300			200			300			200	μV
Warmup Drift		2			1			2			1		ppm
Tmin - Tmax <sup>(1)</sup>			200			100			400			200	μV
Long-Term Stability		6			*			*			*		ppm/1000hr.
Noise (.1-10Hz)		1.0			*			*			*		μVpp
<b>OUTPUT CURRENT</b>													
Range	±10			*			*			*			mA
<b>REGULATION</b>													
Line		3	10		*	*		*	*		*	*	ppm/V
Load		3			*			*			*		ppm/mA
<b>OUTPUT ADJUSTMENT</b>													
Range		20			*			*			*		mV
Temperature Coefficient		1			*			*			*		μV/°C/mV
<b>POWER SUPPLY CURRENTS <sup>(2)</sup></b>													
VRE110 +PS		5	7		*	*		*	*		*	*	mA
VRE110/111 -PS		5	7		*	*		*	*		*	*	mA
VRE112 +PS		7	9		*	*		*	*		*	*	mA
VRE112 -PS		4	6		*	*		*	*		*	*	mA

NOTES: \*Same as C Models.

1. Using the box method, the specified value is the maximum deviation from the output voltage at 25°C over the specified operating temperature range.

2. The specified values are unloaded.

# TYPICAL PERFORMANCE CURVES

**V<sub>OUT</sub> vs. TEMPERATURE**

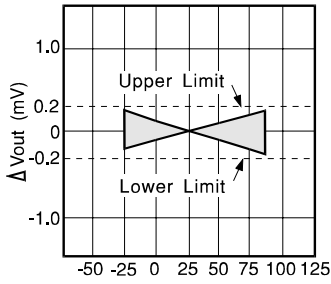

Temperature °C  
VRE110/111/112C

**V<sub>OUT</sub> vs. TEMPERATURE**

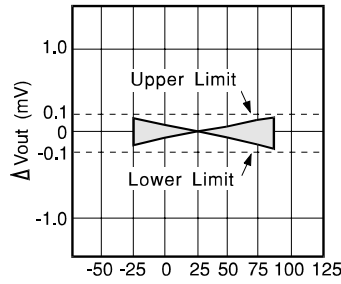

Temperature °C  
VRE110/111/112CA

**V<sub>OUT</sub> vs. TEMPERATURE**

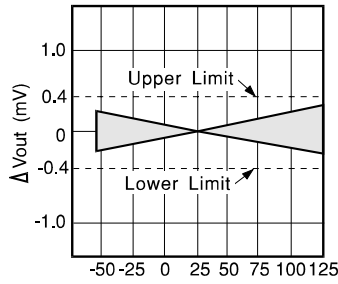

Temperature °C  
VRE110/111/112M

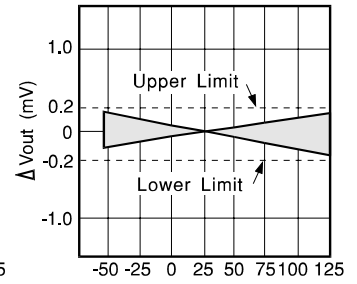

Temperature °C  
VRE110/111/112MA

## VRE110/111

**QUIESCENT CURRENT vs. TEMP**

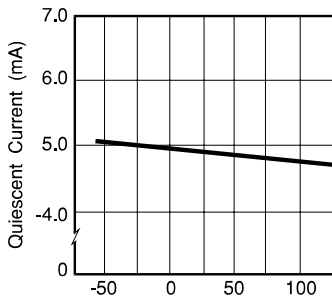

Temperature °C

**JUNCTION TEMP. RISE vs. OUTPUT CURRENT**

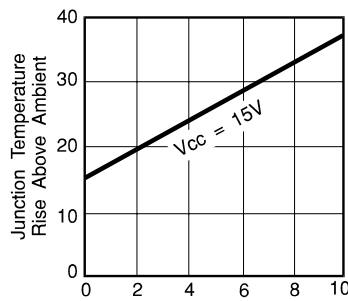

Output Current (mA)

**PSRR vs. FREQUENCY**

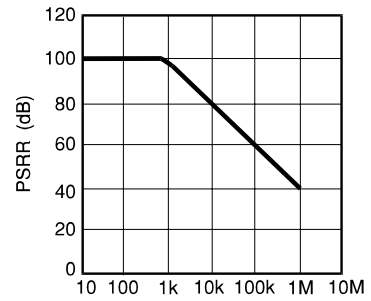

Frequency (Hz)

## VRE112

### POSITIVE OUTPUT

**QUIESCENT CURRENT vs. TEMP**

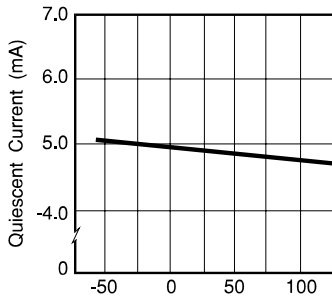

Temperature °C

**JUNCTION TEMP. RISE vs. OUTPUT CURRENT**

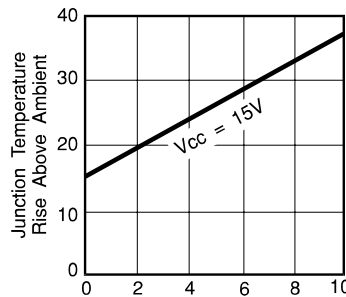

Output Current (mA)

**PSRR vs. FREQUENCY**

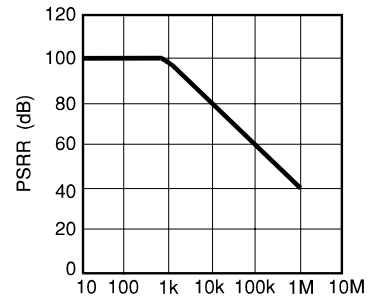

Frequency (Hz)

### NEGATIVE OUTPUT

**QUIESCENT CURRENT vs. TEMP**

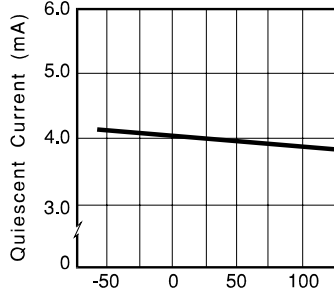

Temperature °C

**JUNCTION TEMP. RISE vs. OUTPUT CURRENT**

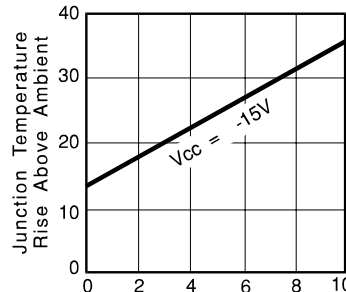

Output Current (mA)

**PSRR vs. FREQUENCY**

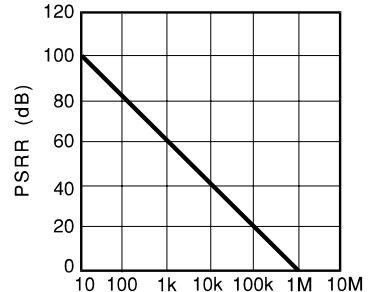

Frequency (Hz)

VRE110DS REV. D NOV 2000

# DISCUSSION OF PERFORMANCE

## THEORY OF OPERATION

The following discussion refers to the schematic below. A FET current source is used to bias a 6.3V zener diode. The zener voltage is divided by the resistor network R1 and R2. This voltage is then applied to the noninverting input of the operational amplifier which amplifies the voltage to produce a 2.500V output. The gain is determined by the resistor networks R3 and R4:  $G=1 + R4/R3$ . The 6.3V zener diode is used because it is the most stable diode over time and temperature.

The current source provides a closely regulated zener current, which determines the slope of the reference's voltage vs. temperature function. By trimming the zener current, a lower drift over temperature can be achieved. But since the voltage vs. temperature function is nonlinear, this method leaves a residual error over wide temperature ranges.

To remove this residual error, Thaler Corporation has developed a nonlinear compensation network of thermistors and resistors that is used in the VRE110 series references. This proprietary network eliminates most of the nonlinearity in the voltage vs. temperature function. By then adjusting the slope, Thaler Corporation produces a very stable voltage over wide temperature ranges. This network is less than 2% of the overall network resistance so it has a negligible effect on long term stability.

## APPLICATION INFORMATION

Figure 1 shows the proper connection of the VRE110 series voltage reference with the optional trim resistors. When trimming the VRE112, the positive voltage should be trimmed first since the negative voltage tracks the positive side. Pay careful attention to the circuit layout to avoid noise pickup and voltage drops in the lines.

The VRE110 series voltage references have the ground terminal brought out on two pins (pin 6 and pin 7) which are connected together internally. This allows the user to achieve greater accuracy when using a socket. Voltage references have a voltage drop across their power supply ground pin due to quiescent current flowing through the contact resistance. If the contact resistance was constant with time and temperature, this voltage drop could be trimmed out. When the reference is plugged into a socket, this source of error can be as high as 20ppm. By connecting pin 7 to the power supply ground and pin 6 to a high impedance ground point in the measurement circuit, the error due to the contact resistance can be eliminated. If the unit is soldered into place the contact resistance is sufficiently small that it doesn't effect performance.

### VRE110

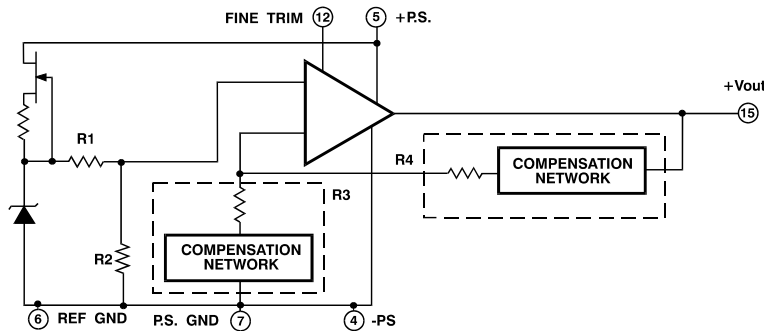

### VRE112

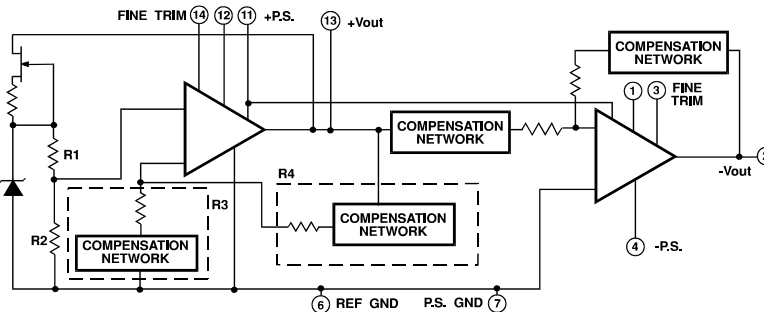

## EXTERNAL CONNECTIONS

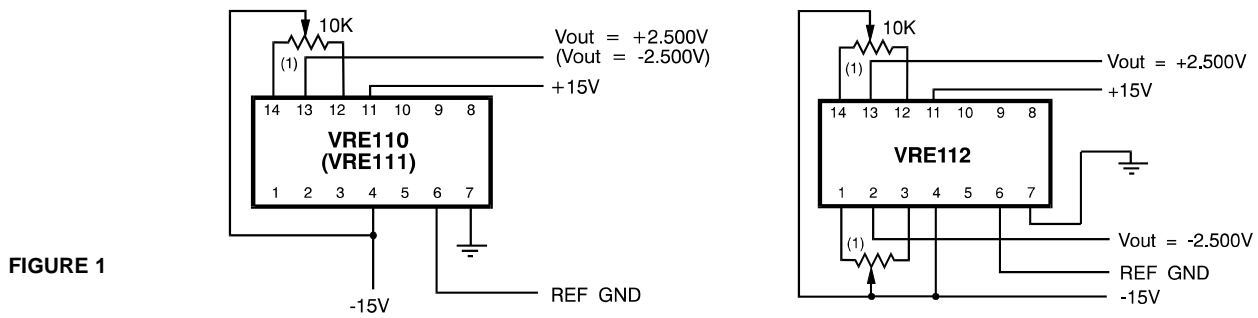

1. Optional Fine Adjust for approximately  $\pm 5\text{mV}$ . VRE111 trim pot center tap connect to -15V.

## PIN CONFIGURATION

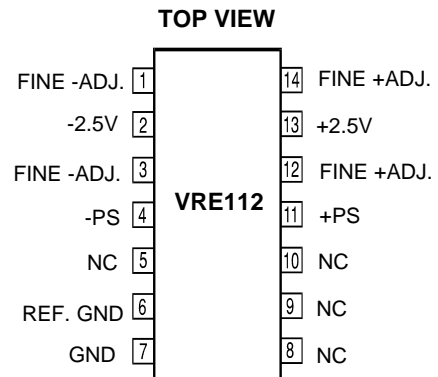
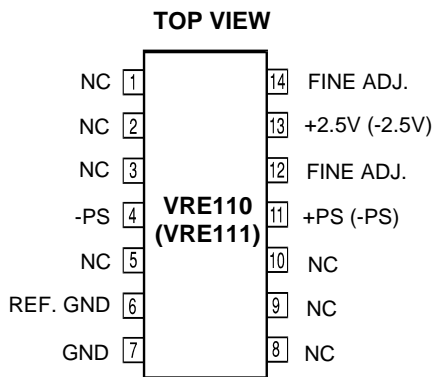

## MECHANICAL

### 14-PIN HYBRID PACKAGE

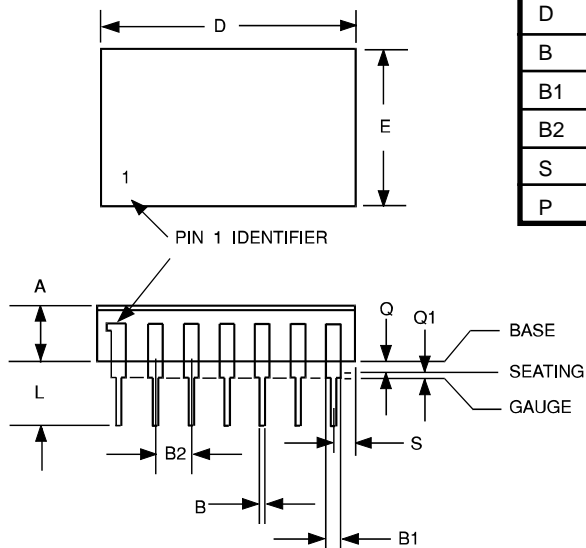

DIM	INCHES		MILLIMETER		DIM	INCHES		MILLIMETER	
	MIN	MAX	MIN	MAX		MIN	MAX	MIN	MAX
E	.480	.500	12.1	12.7	A	.120	.155	3.0	4.0
L	.195	.215	4.9	5.4	Q	.015	.035	0.4	0.9
D	.775	.805	19.7	20.4	Q1	N/A	.030	N/A	0.7
B	.016	.020	0.4	0.5	C	.009	.012	0.2	0.3
B1	.038	.042	0.9	1.0	G1	.290	.310	7.3	7.8
B2	.095	.105	2.4	2.6					
S	.085	.105	2.1	2.6					
P	.004	.006	0.10	0.15					