

HFEF SERIES

High Frequency EMI Filters with UU & R cores

www.DataSheet4U.com

Features

- High frequency design
- Against radiated noise
- An open-body anti-noise choke coil a large inductance for a great noise control effect.
- Excellent mechanical strength
- High reliability and variant PCB-mount housing
- Suitable for wave soldering
- Low resistance and temperature rise.
- Suitable for high-density insertion

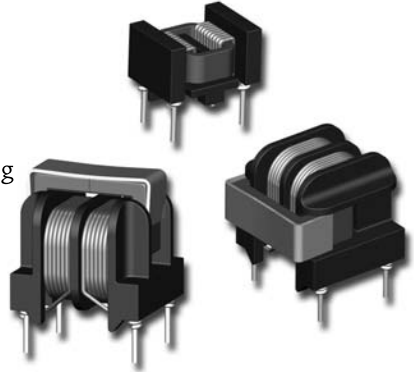

Common Mode Chokes

Part Number	Inductance (mH) min.	Turn Ratio ± 0,2%	D.C.R. (Ω) Max	Hi-Pot Isolation Voltage
HFEF-333UV	33	1 : 1	13,50	2500V
HFEF-702UV	7	1 : 1	2,50	2500V
HFEF-332UV	3,3	1 : 1	1,20	2500V
HFEF-102UV	1	1 : 1	0,90	2500V
HFEF-433UH	43	1 : 1	14,50	2500V
HFEF-143UH	14	1 : 1	5,50	2500V
HFEF-502UH	5	1 : 1	1,80	2500V
HFEF-222UH	2,2	1 : 1	1,00	2500V

Part Number	Nominal Inductance (μH) ±35%	Turn Ratio ± 0%	D.C.R. (Ω) Max	Rated Current (A) Max	Hi-Pot Isolation Voltage
HFEF-10RH	10	1 : 1	50	2,00	500V
HFEF-20RH	20	1 : 1	50	1,50	500V
HFEF-50RH	50	1 : 1	50	1,50	500V
HFEF-60RH	60	1 : 1	80	1,50	500V
HFEF-80RH	80	1 : 1	80	1,50	500V
HFEF-100RH	100	1 : 1	100	1,00	500V
HFEF-200RH	200	1 : 1	150	0,60	500V

Dimensions (in mm)

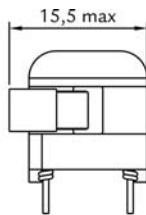
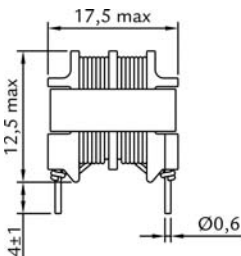

HV

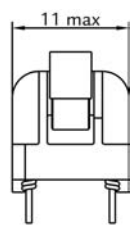
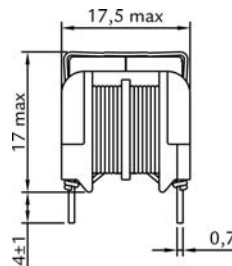

UV

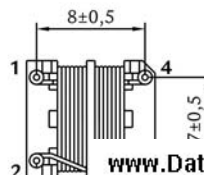
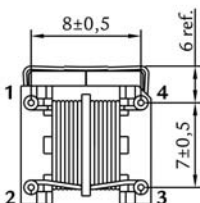

www.DataSheet4U.com

HFEF SERIES

High Frequency EMI Filters with UU & R cores

www.DataSheet4U.com

Common Mode Chokes

Dimensions (in mm)

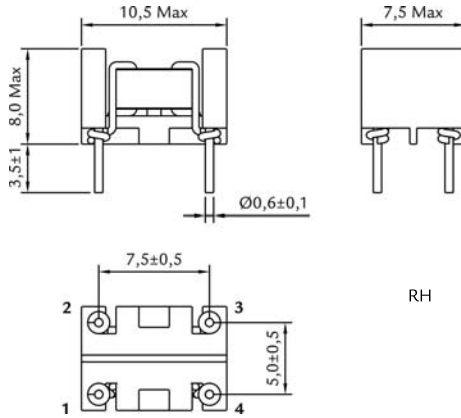

Electrical Schematic

