

3ch VIDEO AMPLIFIER FOR COLOR DIFFERENCE SIGNAL

■GENERAL DESCRIPTION

The NJM2569 is a 3ch video amplifier for color difference signal (R-Y,B-Y).

It composes the output circuit of video items for color difference signal, because prepares clamp circuit, LPF, GCA.

Also it is suitable for portable items because of power save circuit.

■OUTLINE PACKAGE

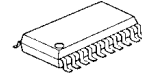

NJM2569V

■FEATURES

- Operating Voltage 4.5 to 5.5V
- Operating Current 17.0mA typ. at Vcc1=4.8V
7.0mA typ. at Vcc2=4.8V
- Operating Current at Power Save 1.5mA typ. at Vcc1=4.8V
5.0uA typ. at Vcc2=4.8V
- Internal Low Pass Filter
- Internal Gain Control Amplifier
- Bipolar Technology
- Package Outline SSOP20

■BLOCK DIAGRAM

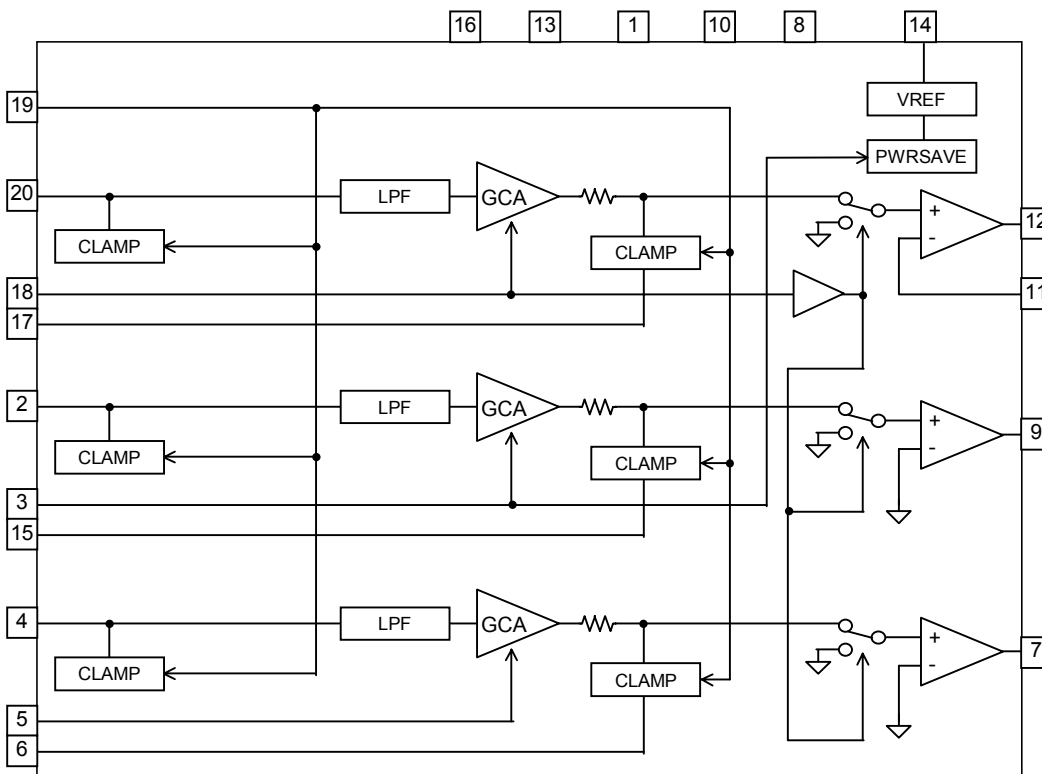

PIN FUNCTION

- 1.Vcc1
- 2.Cb in
- 3.GCA CTL2
- 4.Cr in
- 5.GCA CTL3
- 6.CLAMP3
- 7.Cr out
- 8.GND1
- 9.Cb out
- 10.GND2(Driver)
- 11.Y_{SAG}
- 12.Yout
- 13.Vcc2(Driver)
- 14.Vref
- 15.CLAMP2
- 16.NC
- 17.CLAMP1
- 18.GCA CTL1
- 19.CP
- 20.Yin

■ABSOLUTE MAXIMUM RATINGS

(Ta=25°C)

PARAMETER	SYMBOL	RATINGS	UNIT
Supply Voltage	Vcc	7.0	V
Power Dissipation	P _D	300	mW
Operating Temperature Range	Topr	-40 to +85	°C
Storage Temperature Range	Tstg	-40 to +125	°C

■RECOMMENDED OPERATING CONDITIONS

(Ta=25°C)

PARAMETER	SYMBOL	TEST CONDITION	MIN.	TYP.	MAX.	UNIT
Operating Voltage	Vopr	Vcc1,Vcc2-GND1,GND2	4.5	4.8	5.5	V

■ELECTRICAL CHARACTERISTICS (Vcc1=4.8V,Vcc2=4.8V,RL=75Ω,Ta=25°C)

PARAMETER	SYMBOL	TEST CONDITION	MIN.	TYP.	MAX.	UNIT
Operating Current 1	Icc1	Vcc1	-	17.0	27.0	mA
Operating Current 2	Icc2	Vcc2	-	7.0	12.0	mA
Operating Current at Power Save 1	Icc1ps	Vcc1, At Power Save	-	1.5	5.0	mA
Operating Current at Power Save 2	Icc2ps	Vcc2, At Power Ssave	-	5.0	100.0	uA

[Y Amplifier Characteristics]

Voltage Gain 1	G _{VY1}	Y _{IN} →Y _{OUT} , GCACTL1=0.5V, 0.5Vpp, Input Sine Wave Video Signal (100kHz, 0.35Vpp Sine Wave)	-2.6	0.4	3.4	dB
Voltage Gain 2	G _{VY2}	Y _{IN} →Y _{OUT} , GCACTL1=1.3V, 0.5Vpp, Input Sine Wave Video Signal (100kHz, 0.35Vpp Sine Wave)	3.3	6.3	9.3	dB
Voltage Gain 3	G _{VY3}	Y _{IN} →Y _{OUT} , GCACTL1=2.5V, 0.5Vpp, Input Sine Wave Video Signal (100kHz, 0.35Vpp Sine Wave)	8.2	11.2	14.2	dB

[Cb Amplifier Characteristics]

Voltage Gain 1	G _{VCb1}	Cb _{IN} →Cb _{OUT} , GCACTL2=0.5V, 0.35Vpp, Input Sine Wave Video Signal (100kHz, 0.35Vpp Sine Wave)	-2.6	0.4	3.4	dB
Voltage Gain 2	G _{VCb2}	Cb _{IN} →Cb _{OUT} , GCACTL2=1.3V, 0.35Vpp, Input Sine Wave Video Signal (100kHz, 0.35Vpp Sine Wave)	3.3	6.3	9.3	dB
Voltage Gain 3	G _{VCb3}	Cb _{IN} →Cb _{OUT} , GCACTL2=2.5V, 0.35Vpp, Input Sine Wave Video Signal (100kHz, 0.35Vpp Sine Wave)	8.2	11.2	14.2	dB

[Cr Amplifier Characteristics]

Voltage Gain 1	G _{VCr1}	Cr _{IN} →Cr _{OUT} , GCACTL3=0.5V, 0.35Vpp, Input Sine Wave Video Signal (100kHz, 0.35Vpp Sine Wave)	-2.6	0.4	3.4	dB
Voltage Gain 2	G _{VCr2}	Cr _{IN} →Cr _{OUT} , GCACTL3=1.3V, 0.35Vpp, Input Sine Wave Video Signal (100kHz, 0.35Vpp Sine Wave)	3.3	6.3	9.3	dB
Voltage Gain 3	G _{VCr3}	Cr _{IN} →Cr _{OUT} , GCACTL3=2.5V, 0.35Vpp, Input Sine Wave Video Signal (100kHz, 0.35Vpp Sine Wave)	8.2	11.2	14.2	dB

[GCA Control Signal]

GCACTL	V _{GH}	GCACTL1,2,3 Input control voltage range	0.5	-	Vcc	V
	V _{GL}	MUTE change value	0	-	0.3	

■ELECTRICAL CHARACTERISTICS (Vcc1=4.8V,Vcc2=4.8V,RL=75Ω,Ta=25°C)

PARAMETER	SYMBOL	TEST CONDITION	MIN.	TYP.	MAX.	UNIT
[Filter Characteristics]						
LPF(Y _{IN} →Y _{OUT})	Gf _{Y6.75M}	6.75MHz/100kHz, input sine wave video signal (100mVpp sine wave)	-3.0	-1.0	-	dB
	Gf _{Y12M}	12MHz/100kHz, input sine wave video signal (100mVpp sine wave)	-	-3.0	-	dB
	Gf _{Y27M}	27MHz/100kHz, input sine wave video signal (100mVpp sine wave)	-	-40.0	-15.0	dB
LPF(Cb _{IN} →Cb _{OUT})	Gf _{Cb6.75M}	6.75MHz/100kHz, input sine wave video signal (100mVpp sine wave)	-3.0	-1.0	-	dB
	Gf _{Cb27M}	27MHz/100kHz, input sine wave video signal (100mVpp sine wave)	-	-40.0	-15.0	dB
LPF(Cr _{IN} →Cr _{OUT})	Gf _{Cr6.75M}	6.75MHz/100kHz, input sine wave video signal (100mVpp sine wave)	-3.0	-1.0	-	dB
	Gf _{Cr27M}	27MHz/100kHz, input sine wave video signal (100mVpp sine wave)	-	-40.0	-15.0	dB
[Crosstalk Characteristics]						
Crosstalk 1	CT1	Input Red Field Signal(3.58MHz) to Y _{IN} . Measure Cr _{OUT} /Y _{OUT} .	-	-50	-	dB
Crosstalk 2	CT2	Input Red Field Signal(3.58MHz) to Y _{IN} . Measure Cb _{OUT} /Y _{OUT} .	-	-50	-	dB
Crosstalk 3	CT3	Input Red Field Signal(3.58MHz) to Cb _{IN} . Measure Y _{OUT} /Cb _{OUT} .	-	-50	-	dB
Crosstalk 4	CT4	Input Red Field Signal(3.58MHz) to Cb _{IN} . Measure Cr _{OUT} /Cb _{OUT} .	-	-50	-	dB
Crosstalk 5	CT5	Input Red Field Signal(3.58MHz) to Cr _{IN} . Measure Y _{OUT} /Cr _{OUT} .	-	-50	-	dB
Crosstalk 6	CT6	Input Red Field Signal(3.58MHz) to Cr _{IN} . Measure Cb _{OUT} /Cr _{OUT} .	-	-50	-	dB
MUTE Crosstalk 1	MCT1	Input Red Field Signal(3.58MHz) to Y _{IN} . Measure ratio of Y _{IN} to Y _{OUT} at MUTE.	-	-50	-	dB
MUTE Crosstalk 2	MCT2	Input Red Field Signal(3.58MHz) to Cb _{IN} . Measure ratio of Cb _{IN} to Cb _{OUT} at MUTE.	-	-50	-	dB
MUTE Crosstalk 3	MCT3	Input Red Field Signal(3.58MHz) to Cr _{IN} . Measure ratio of Cr _{IN} to Cr _{OUT} at MUTE.	-	-50	-	dB
[S/N Ratio]						
Y System S/N	SN _Y	Band width 100kHz to 6MHz, RL=75Ω, Input 100% White Video Signal. Measure Y _{OUT} .	-	-55	-	dB
Cb System S/N	SN _{Cb}	Band width 100kHz to 6MHz, RL=75Ω, Input 100% White Video Signal. Measure Cb _{OUT} .	-	-55	-	dB
Cr System S/N	SN _{Cr}	Band width 100kHz to 6MHz, RL=75Ω, Input 100% White Video Signal. Measure Cr _{OUT} .	-	-55	-	dB
[CP Signal *]						
CP Input Change Voltage	VCP _H	ON level	2.4	-	Vcc	V
	VCP _L	OFF level	0	-	0.8	

NJM2569

www.DataSheet4U.com

*CP Input

Don't put CP signal on Sync signal and picture period. Keep margin of 0.2uS over of $\Delta t1$ and $\Delta t2$.

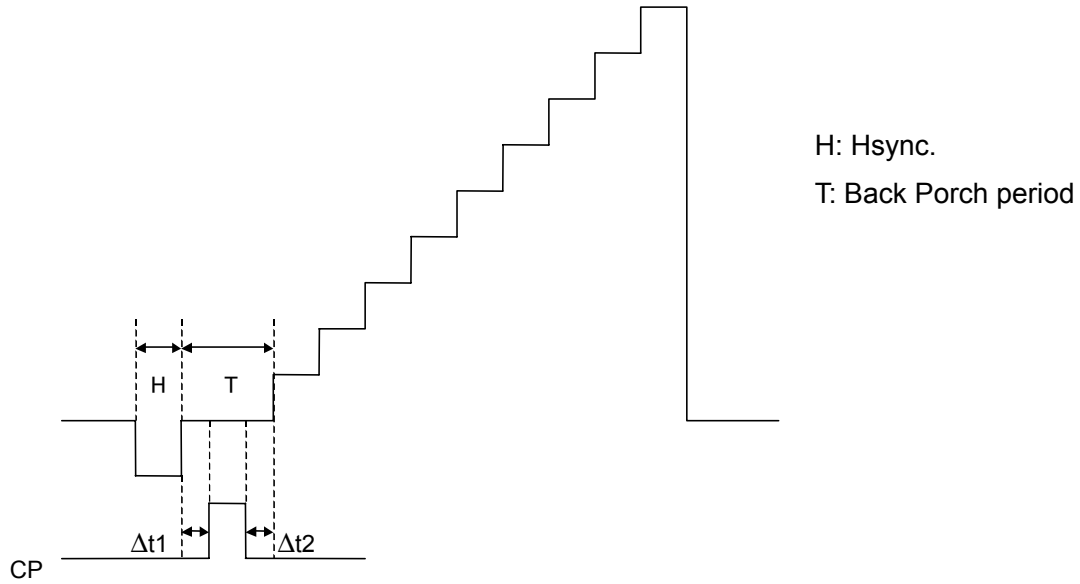

TYPICAL CHARACTERISTICS

Operating Current 1 vs. Supply Voltage
(Ta=25°C)

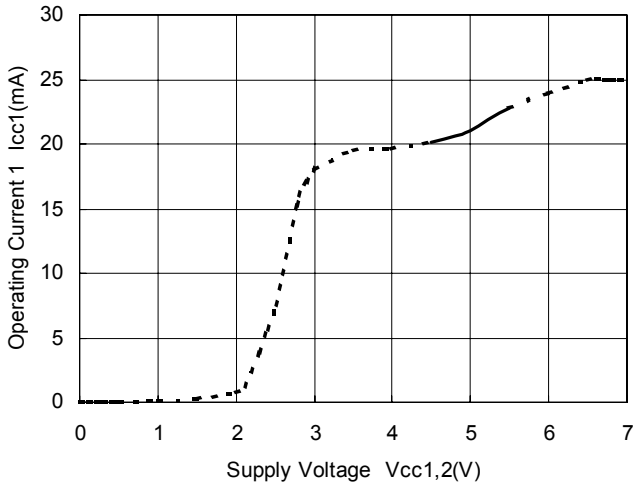

Operating Current 2 vs. Supply Voltage
(Ta=25°C)

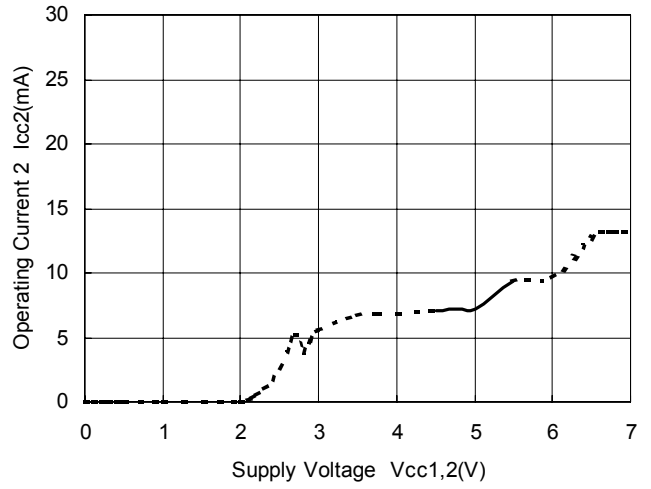

Operating Current at Power Save 1 vs. Supply Voltage
(Ta=25°C)

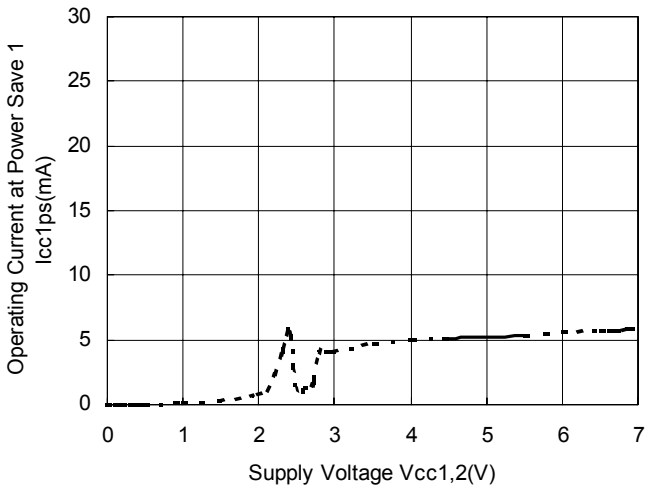

Operating Current at Power Save 2 vs. Supply Voltage
(Ta=25°C)

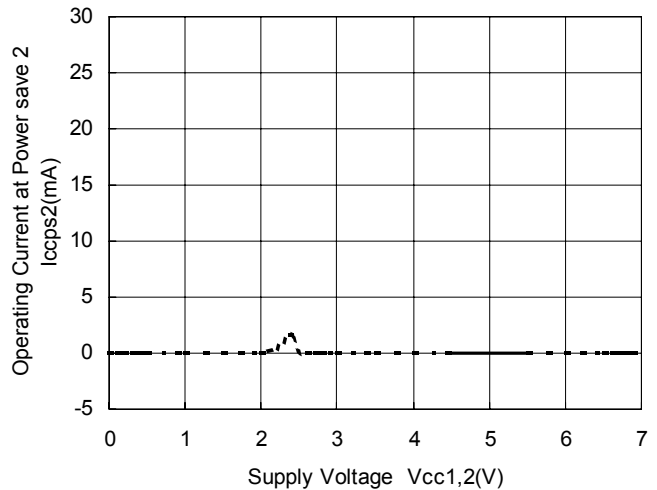

Y System Filter Characteristics
(Vcc=4.8V)

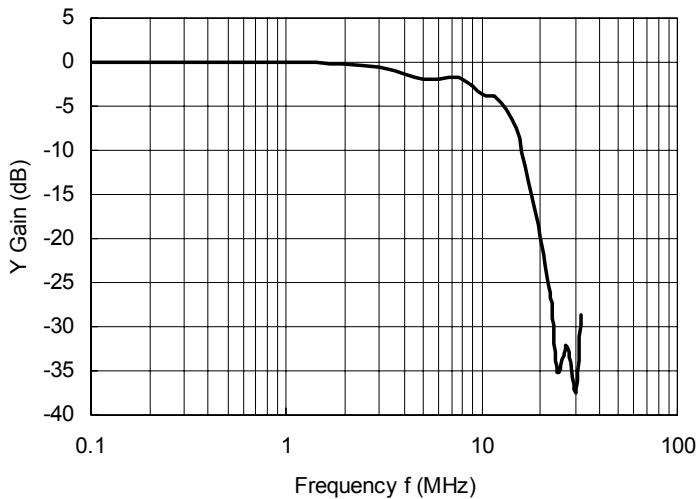

Cb System Filter Characteristics
(Vcc=4.8V)

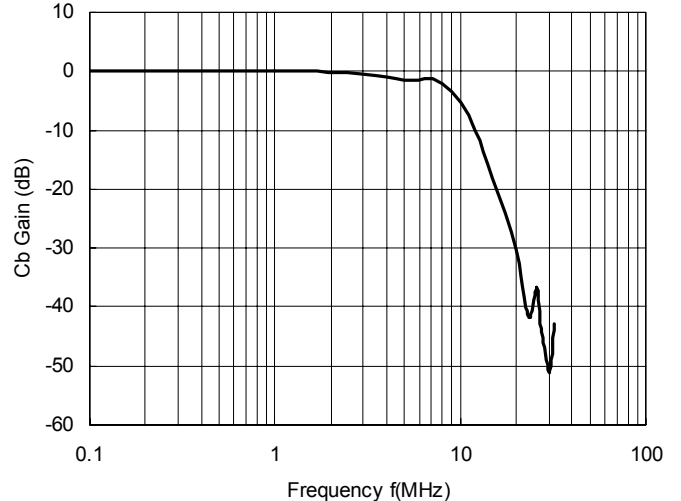

■ TYPICAL CHARACTERISTICS

Cr System Filter Characteristics
(Vcc=4.8V)

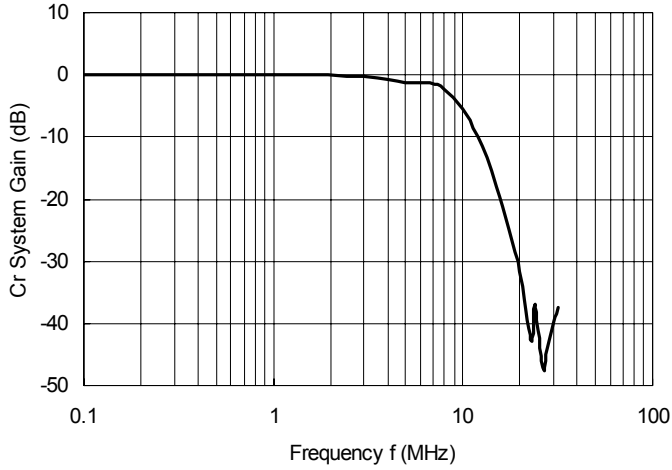

Y System GAIN vs. GCACTL
(Vcc=4.8V)

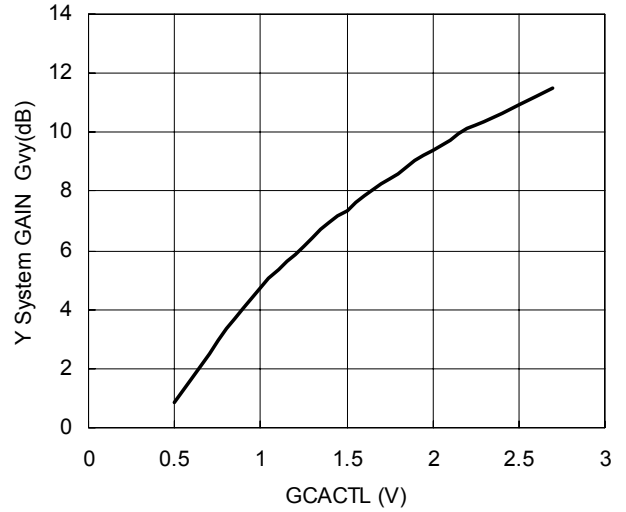

Cb System GAIN vs. GCACTL
(Vcc=4.8V)

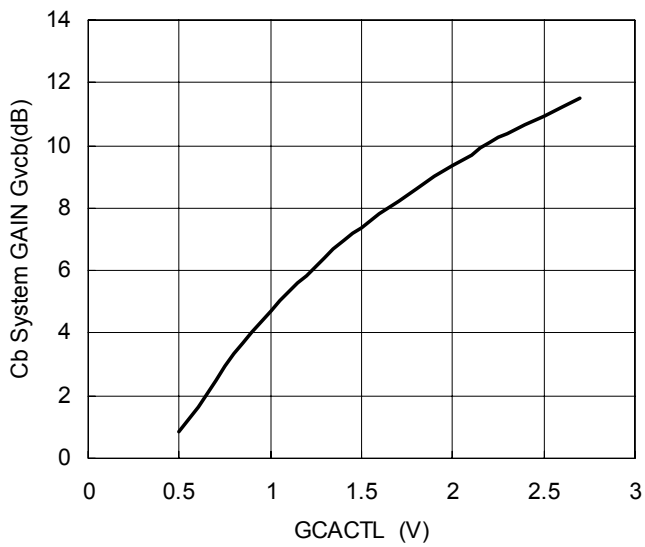

Cr System GAIN vs. GCACTL
(Vcc=4.8V)

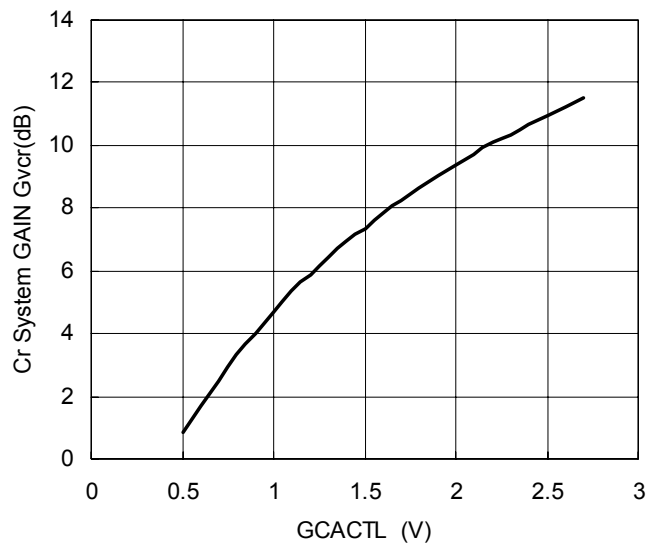

MEMO

[CAUTION]
The specifications on this databook are only given for information , without any guarantee as regards either mistakes or omissions. The application circuits in this databook are described only to show representative usages of the product and not intended for the guarantee or permission of any right including the industrial rights.