

MMA703

DC to 6 GHz Amplifier

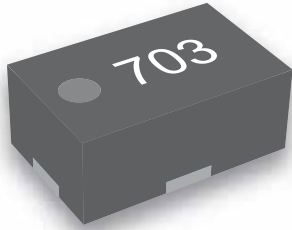

2012 PACKAGE

Description:

The MMA703 is a fully matched amplifier fabricated in Aeroflex / Metelics reliable InGaP HBT technology. The economical, low parasitic molded package provides state-of-the-art wideband performance.

Features:

- DC - 6 GHz Broadband Gain Block
- ± 0.5 dB Typical Gain Flatness
- 50 Ohms Input/Output Impedances

RF Specifications:

Parameter	Term	Minimum	Typical	Maximum	Units
3dB Bandwidth	BW	DC	- - -	9	GHz
Frequency Range	f_0	DC	- - -	6	GHz
Gain	G_p	17	18	- - -	dB
Output Power	P_{1dB}	+16	+17	- - -	dBm
Standing Wave Ratio	VSWR	1.5:1	2.0:1	- - -	- - -
3 rd Order Intercept Point	IP3	+23	+25	- - -	dBm
Noise Figure	NF	- - -	3.8	4.2	dB
Device current	I_c	42	48	55	mA

- NOTES:
1. $T_A = +25$ °C.
 2. $V_S = 6.0$ Vdc, $R_{BIAS} = 22$ Ω
 3. IP3 measured with two tones offset 10 MHz at 0 dBm per tone.

Absolute Maximum Ratings:

Parameters	Rating
Device Current (I_c)	80 mA
RF Input Power, continuous	+10 dBm
Operating Temperature	-40 to +85 °C
Storage Temperature	-55 to +125 °C
Thermal Resistance (θ_{JC})	125 °C/W

Typical RF Performance:

Figure 1.

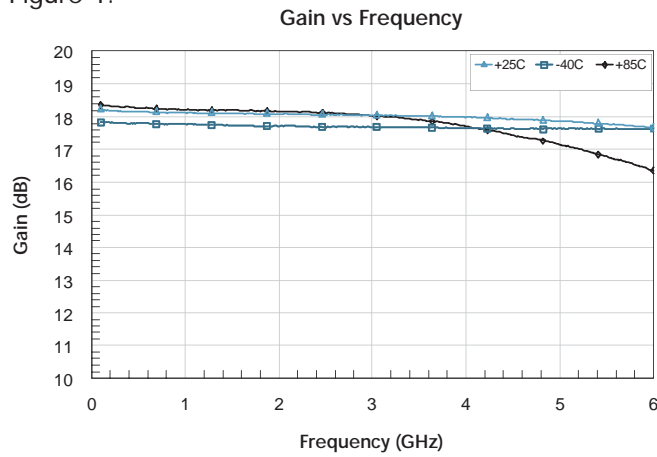

Figure 2.

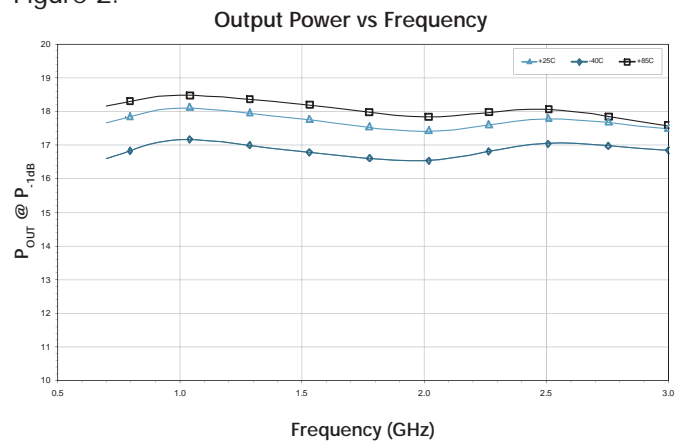

Figure 3.

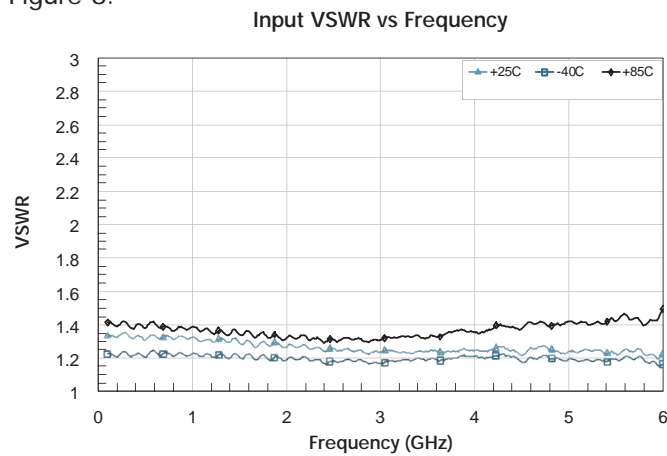

Figure 4.

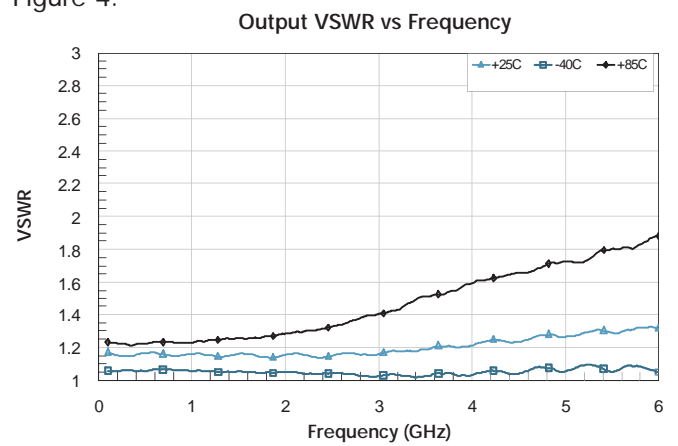

Figure 5.

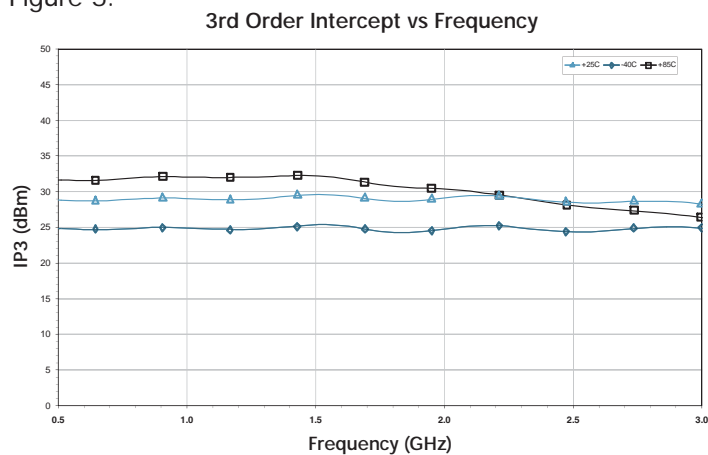
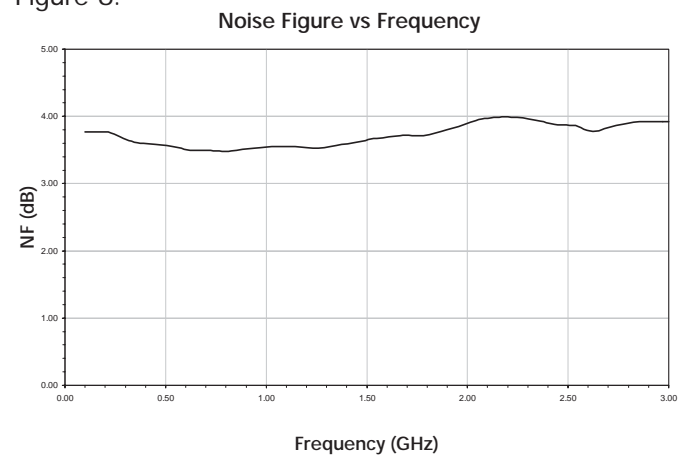

Figure 6.



MMA703 DC to 6 GHz Amplifier



2012 Package Dimensions:

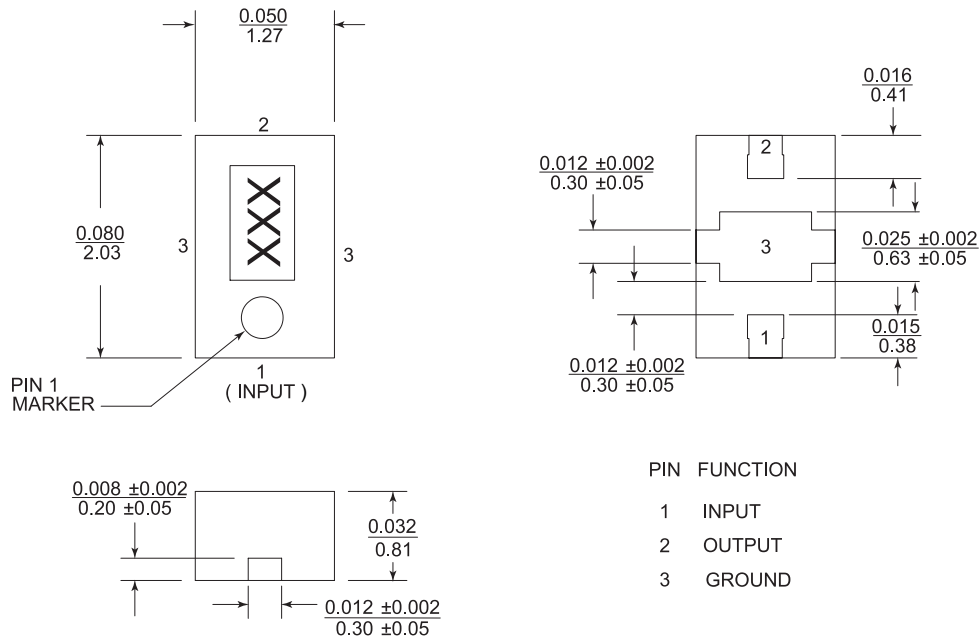

ALL DIMENSIONS ±0.003 INCH
0.07 MM

Recommended PCB Layout:

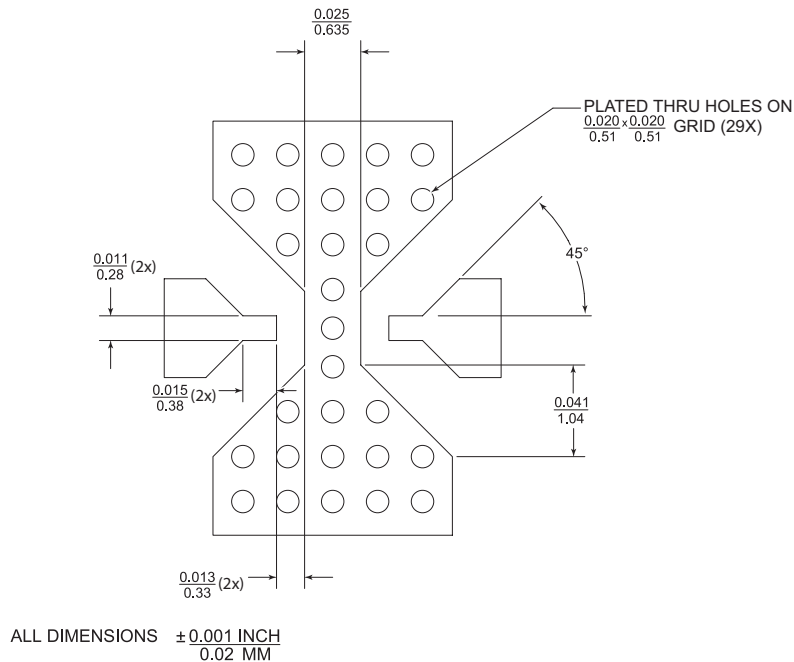

Application Circuit:

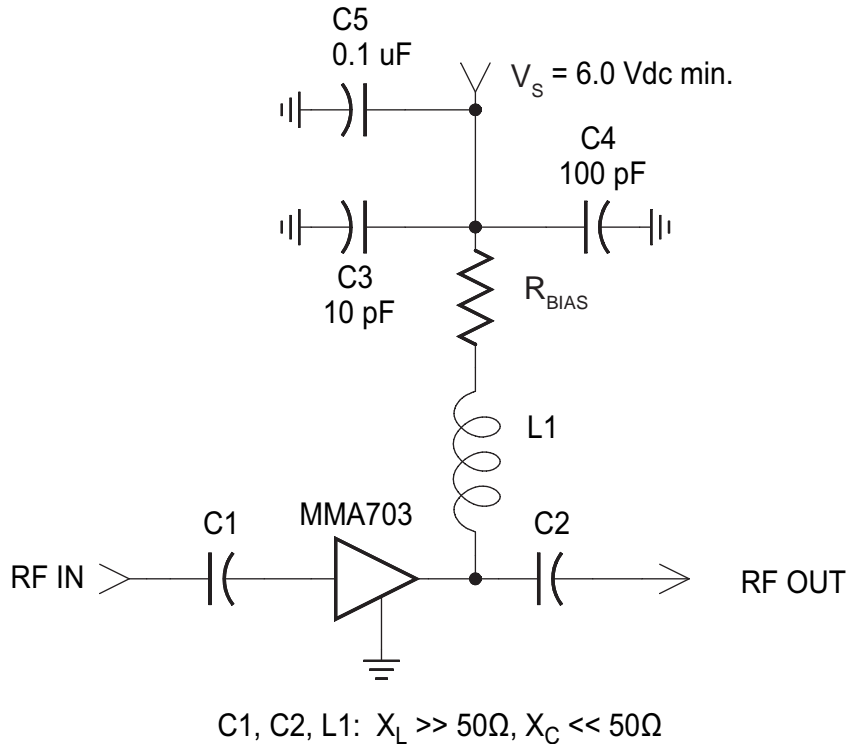

R_{BIAS} vs. V_S

V_S (V)	6.0	8.0	10.0	12.0	15.0
R_{BIAS} (Ω)	22	43	86	130	200
Power Dissipation (W)	0.10	0.2	0.5	1	2

Aeroflex / Metelics Inc.
 Aeroflex Microelectronic Solutions
 975 Stewart Drive, Sunnyvale, CA 94085
 TEL: 408-737-8181
 Fax: 408-733-7645

www.aeroflex-metelics.com sales@eroflex-metelics.com

Aeroflex / Metelics, Inc. reserves the right to make changes to any products and services herein at any time without notice. Consult Aeroflex or an authorized sales representative to verify that the information in this data sheet is current before using this product. Aeroflex does not assume any responsibility or liability arising out of the application or use of any product or service described herein, except as expressly agreed to in writing by Aeroflex; nor does the purchase, lease, or use of a product or service from Aeroflex convey a license under any patent rights, copyrights, trademark rights, or any other of the intellectual rights of Aeroflex or of third parties.

Copyright 2003 Aeroflex / Metelics. All rights reserved.



Our passion for performance is defined by three attributes represented by these three icons: solution-minded, performance-driven and customer-focused.