



# QST108

## Capacitive touch sensor device 8 keys with individual key state outputs or I<sup>2</sup>C interface

Not For New Design

### Features

- Patented charge-transfer design
- Up to 8 independent QTouch™ keys supported
- Individual key state outputs or I<sup>2</sup>C interface
- Fully “debounced” results
- Patented AKS™ Adjacent Key Suppression
- Self-calibration and auto drift compensation
- Spread-spectrum bursts to reduce EMI
- Up to 5 general-purpose outputs
- ECOPACK® (RoHS compliant) package

### Applications

This device specifically targets human interfaces and front panels for a wide range of applications such as PC peripherals, home entertainment systems, gaming devices, lighting and appliance controls, remote controls, etc.

QST devices are designed to replace mechanical switching/control devices and the reduced number of moving parts in the end product provides the following advantages:

- Lower customer service costs
- Reduced manufacturing costs
- Increased product lifetime

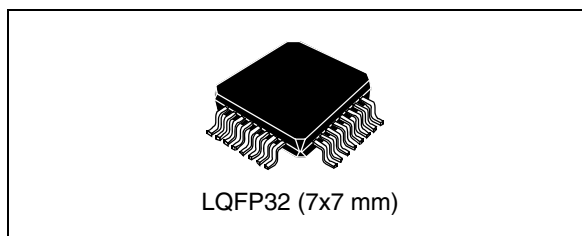

### Description

The QST108 is the ideal solution for the design of capacitive touch sensing user interfaces.

Touch-sensitive controls are increasingly replacing electromechanical switches in home appliances, consumer and mobile electronics, and in computers and peripherals. Capacitive touch controls allow designers to create stylish, functional, and economical designs which are highly valued by consumers, often at lower cost than the electromechanical solutions they replace.

The QST108 QTouch™ sensor IC is a pure digital solution based on Quantum's patented charge-transfer (QProx™) capacitive technology.

QTouch™ and QProx™ are trademarks of the Quantum Research Group.

**Table 1. Device summary**

Feature	Order codes
	QST108KT6
Operating supply voltage	2.4 to 5.5 V
Supported interfaces	Individual key state outputs or I <sup>2</sup> C Interface
Operating temperature	-40° to +85° C
Package	LQFP32 (7x7 mm)

# Contents

<b>1</b>	<b>Device overview</b>	<b>5</b>
<b>2</b>	<b>Pin description</b>	<b>6</b>
<b>3</b>	<b>QST touch sensing technology</b>	<b>8</b>
3.1	Functional description	8
3.2	Spread-spectrum operation	8
3.3	Faulty and unused keys	9
3.4	Detection threshold levels	9
3.5	Detection integrator filter	9
3.6	Self-calibration	10
3.7	Fast positive recalibration	10
3.8	Forced key recalibration	10
3.9	Max On-Duration	11
3.10	Drift compensation	11
3.11	Adjacent key suppression (AKS™)	12
<b>4</b>	<b>Device operating modes</b>	<b>13</b>
4.1	Reset and power-up	13
4.2	Burst operation	13
4.3	Low power mode	13
4.4	Mode selection	14
4.5	Stand-alone mode	15
4.5.1	Main features	15
4.5.2	KOUT outputs	16
4.5.3	Option descriptions	17
4.6	I2C mode	19
4.6.1	Main features	19
4.6.2	General-purpose outputs	20
4.6.3	IRQ pin	20
4.6.4	Communication packet	20
4.6.5	I2C address selection	21
4.7	Supported commands	21

<b>5</b>	<b>Design guidelines</b>	<b>27</b>
5.1	C <sub>S</sub> sense capacitor	27
5.2	Sensitivity tuning	27
5.2.1	Increasing sensitivity	27
5.2.2	Decreasing sensitivity	27
5.2.3	Key balance	27
5.3	Power supply	28
5.4	ESD protection	28
5.5	Crosstalk precautions	28
5.6	PCB layout and construction	28
<b>6</b>	<b>Electrical characteristics</b>	<b>30</b>
6.1	Parameter conditions	30
6.1.1	Minimum and maximum values	30
6.1.2	Typical values	30
6.1.3	Typical curves	30
6.1.4	Loading capacitor	30
6.1.5	Pin input voltage	30
6.2	Absolute maximum ratings	31
6.3	EMC characteristics	32
6.3.1	Functional EMS (electro magnetic susceptibility)	32
6.3.2	Electro magnetic interference (EMI)	32
6.3.3	Absolute maximum ratings (electrical sensitivity)	33
6.4	Operating conditions	34
6.5	Supply current characteristics	34
6.6	Capacitive sensing characteristics	35
6.7	KOUTn/OPTn/GPON pin characteristics	36
6.7.1	General characteristics	36
6.7.2	Output pin characteristics	36
6.8	RESET pin	39
6.9	I2C control interface	40
<b>7</b>	<b>Package mechanical data</b>	<b>42</b>
7.1	Soldering information	45
<b>8</b>	<b>Part numbering</b>	<b>46</b>
<b>9</b>	<b>Device revision information</b>	<b>47</b>

---

9.1	Device revision identification .....	47
9.2	Device revision history .....	47
9.2.1	Revision 2.1 .....	47
9.2.2	Revision 2.3 .....	48
<b>10</b>	<b>Revision history .....</b>	<b>49</b>

# 1 Device overview

The QST108 capacitive touch sensor IC is a pure digital solution based on Quantum's patented charge-transfer (QProx™) capacitive technology.

This technology allows users to create simple touch panel sensing electrode interfaces for conventional or flexible printed circuit boards (PCB/FPCB). Sensing electrodes are part of the PCB layout (copper pattern or printed conductive ink) and may be used in various shapes (circle, rectangular, etc.).

By implementing the QProx™ charge-transfer algorithm, the QST108 detects finger presence (human touch) near electrodes behind a dielectric (glass, plastic, wood, etc.). Only one external sampling capacitor by channel is used in the measuring circuitry to control the detection.

QST technology also incorporates advanced processing techniques such as drift compensation, auto-calibration, noise filtering, and Quantum's patented Adjacent Key Suppression™ (AKS™) to ensure maximum usability and control integrity.

In order to meet environmental requirements, ST offers this device in ECOPACK® packages. These packages have a lead-free second level interconnect. The category of second level interconnect is marked on the package and on the inner box label, in compliance with JEDEC Standard JESD97.

The maximum ratings related to soldering conditions are also marked on the inner box label. ECOPACK is an ST trademark. ECOPACK specifications are available at: [www.st.com](http://www.st.com).

## 2 Pin description

Figure 1. 32-pin package pinout

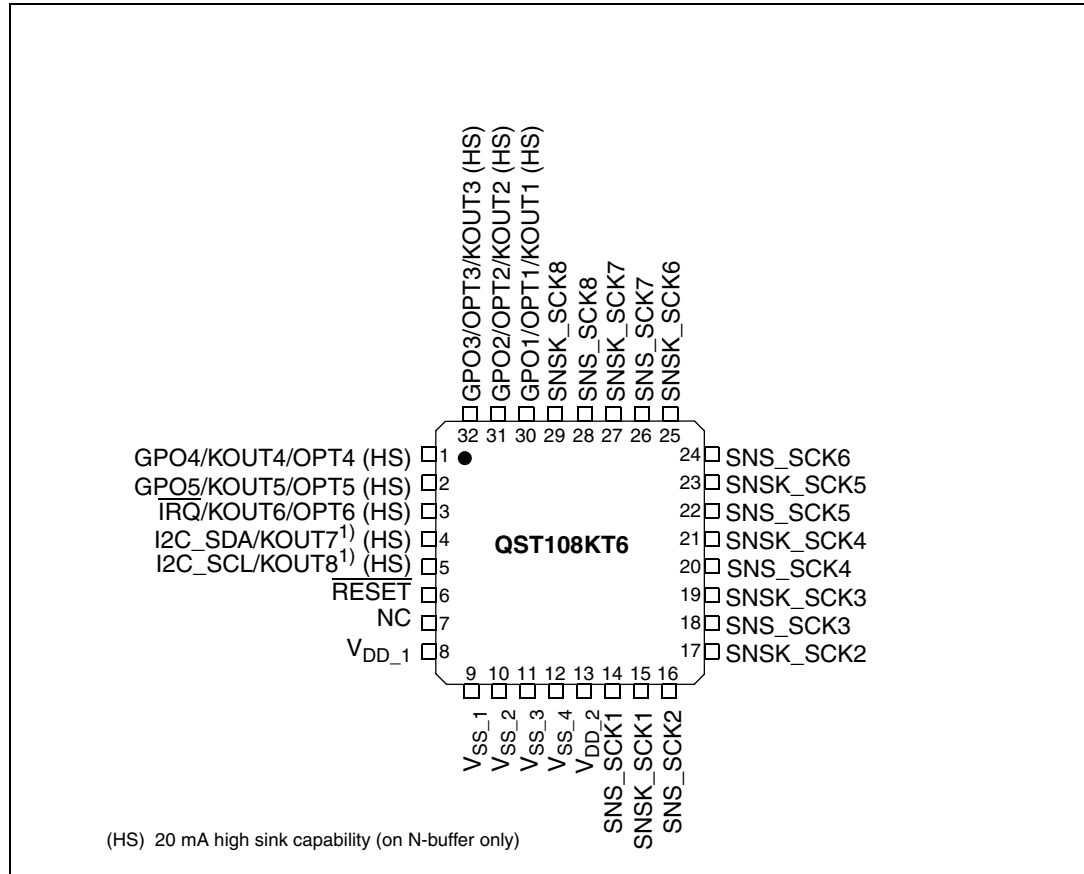

1. An external pull-up is required on these pins.

Table 2. Device pin description

Pin	Pin name	Type <sup>(1)</sup>	Stand-alone mode function	I <sup>2</sup> C mode function	If unused
1	GPO4/OPT4/KOUT4 <sup>(2)</sup>	PP (HS)	Key 4 output / BCD output 4 and MOD_0 option resistor	General purpose output 4 and I <sup>2</sup> C address bit 2 option resistor	Option resistor
2	GPO5/OPT5/KOUT5 <sup>(2)</sup>	PP (HS)	Key 5 output and MOD_1 option resistor	General purpose output 5	Open or option resistor
3	OPT6/KOUT6/ $\overline{\text{IRQ}}$ <sup>(2)</sup>	PP/OD (HS)	Key 6 output and OM_0 option resistor	Interrupt line (active low)	Open or option resistor
4	KOUT7/I2C_SDA <sup>(3)</sup>	TOD (HS)	Key 7 output	I <sup>2</sup> C serial data	Open
5	KOUT8/I2C_SCL <sup>(3)</sup>	TOD (HS)	Key 8 output	I <sup>2</sup> C serial clock	Open

Table 2. Device pin description (continued)

Pin	Pin name	Type <sup>(1)</sup>	Stand-alone mode function	I <sup>2</sup> C mode function	If unused
6	$\overline{\text{RESET}}$	BD	Reset (active low)		10nF capacitor to ground
7	NC		Not connected		
8	V <sub>DD_1</sub>	S	Supply voltage		
9	V <sub>SS_1</sub>	S	Ground voltage		
10	V <sub>SS_2</sub>	S	Ground voltage		
11	V <sub>SS_3</sub>	S	Ground voltage		
12	V <sub>SS_4</sub>	S	Ground voltage		
13	V <sub>DD_2</sub>	S	Supply voltage		
14	SNS_SCK1	SNS	Key 1 sense pin to Cs		Open
15	SNSK_SCK1	SNS	Key 1 sense pin to Cs/Rs		Open
16	SNS_SCK2	SNS	Key 2 sense pin to Cs		Open
17	SNSK_SCK2	SNS	Key 2 sense pin to Cs/Rs		Open
18	SNS_SCK3	SNS	Key 3 sense pin to Cs		Open
19	SNSK_SCK3	SNS	Key 3 sense pin to Cs/Rs		Open
20	SNS_SCK4	SNS	Key 4 sense pin to Cs		Open
21	SNSK_SCK4	SNS	Key 4 sense pin to Cs/Rs		Open
22	SNS_SCK5	SNS	Key 5 sense pin to Cs		Open
23	SNSK_SCK5	SNS	Key 5 sense pin to Cs/Rs		Open
24	SNS_SCK6	SNS	Key 6 sense pin to Cs		Open
25	SNSK_SCK6	SNS	Key 6 sense pin to Cs/Rs		Open
26	SNS_SCK7	SNS	Key 7 sense pin to Cs		Open
27	SNSK_SCK7	SNS	Key 7 sense pin to Cs/Rs		Open
28	SNS_SCK8	SNS	Key 8 sense pin to Cs		Open
29	SNSK_SCK8	SNS	Key 8 sense pin to Cs/Rs		Open
30	GPO1/OPT1/KOUT1 <sup>(2)</sup>	PP (HS)	Key 1 output / BCD output 1 and MODE option resistor	General purpose output 1 and MODE option resistor	Option resistor
31	GPO2/OPT2/KOUT2 <sup>(2)</sup>	PP (HS)	Key 2 output / BCD output 2 and AKS option resistor	General purpose output 2 and I <sup>2</sup> C address bit 0 option resistor	Option resistor
32	GPO3/OPT3/KOUT3 <sup>(2)</sup>	PP (HS)	Key 3 output / BCD output 3 and LP option resistor	General purpose output 3 and I <sup>2</sup> C address bit 1 option resistor	Option resistor

1. S: supply pin, BD: bidirectional pin, SNS: capacitive sensing pin, PP: Output push-pull, OD: Output open-drain, TOD: Output true open-drain and HS: 20mA high sink capability (on N-buffer only)
2. During the reset phase, these pins are floating and their state depends on the option resistor.
3. An external pull-up is required on these pins.

### 3 QST touch sensing technology

#### 3.1 Functional description

QST devices employ bursts of charge-transfer cycles to acquire signals. Burst mode permits low power operation, dramatically reduces RF emissions, lowers susceptibility to RF fields, and yet permits excellent speed. Signals are processed using algorithms pioneered by Quantum which are specifically designed to provide reliable, trouble-free operation over the life of the product.

The QST switches and charge measurement hardware functions are all internal to the device. An external  $C_S$  capacitor accumulates the charge from sense-plate  $C_X$ , which is then measured. Larger values of  $C_X$  cause the charge transferred into  $C_S$  to rise more rapidly, reducing available resolution. As a minimum resolution is required for proper operation, this can result in dramatically reduced gain. Larger values of  $C_S$  reduce the rise of differential voltage across it, increasing available resolution by permitting longer QST bursts. The value of  $C_S$  can thus be increased to allow larger values of  $C_X$  to be tolerated. The device is responsive to both  $C_X$  and  $C_S$ , and changes in either can result in substantial changes in sensor gain.

**Figure 2. QTouch™ measuring circuitry**

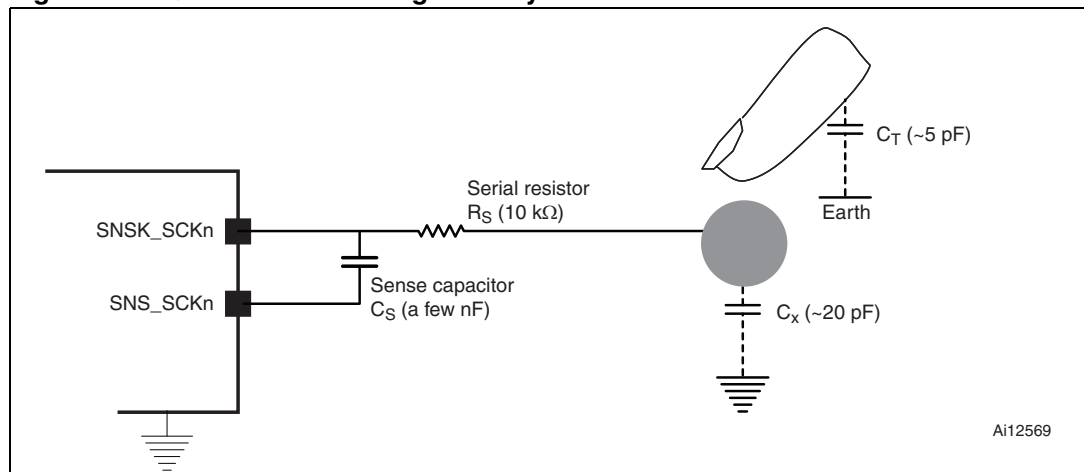

#### 3.2 Spread-spectrum operation

The bursts operate over a spread of frequencies, so that external fields will have minimal effect on key operation and emissions are very weak. Spread-spectrum operation works with the Detection Integrator mechanism (DI) to dramatically reduce the probability of false detection due to noise.



### 3.3 Faulty and unused keys

Any sensing channel that does not have its sense capacitor ( $C_S$ ) fitted is assumed to be either faulty or unused. This channel takes no further part in operation unless a Master-commanded recalibration operation shows it to have an in-range burst count again. Faulty, unused or disabled keys are still bursted but not processed to avoid modifying the sensitivity of active keys.

This is important for sensing channels that have an open or short circuit fault across  $C_S$ . Such channels would otherwise cause very long acquire bursts, and in consequence would slow the operation of the entire QST device.

To optimize touch response time and device power consumption, if some keys are not used, we recommend to try suppressing the ones which belong to the same burst. Bursts which do not have any keys implemented will then not be processed.

### 3.4 Detection threshold levels

The key capacitance change induced by the presence of a finger is sensed by the variation in the number of charge transfer pulses to load the capacitor. The difference in the pulse count number is compared to a threshold in order to detect the key as pressed or not.

Two different thresholds, one for detection and one for the end of detection, create an hysteresis in order to prevent erratic behavior.

The default threshold levels and hysteresis values are described in [Section 6.6: Capacitive sensing characteristics on page 35](#).

### 3.5 Detection integrator filter

The Detection Integrator (DI) filter mechanism works together with spread spectrum operation to dramatically reduce the effects of noise on key states. The DI mechanism requires a specified number of measurements that qualify as detections (and these must occur in a row) or the detection will not be reported.

In a similar manner, the end of a touch (loss of signal) also has to be confirmed over several measurements. It is called the End of Detection Integrator (EDI).

This process acts as a type of “debounce” mechanism against noise.

The default DI and EDI values for confirming start of touch and end of touch are described in [Section 6.6: Capacitive sensing characteristics on page 35](#).

Figure 3 shows an example of detection with DI=2 and EDI=2 meaning 3 consecutive samples are necessary to trigger the key detection or end of detection

**Figure 3. Detection signals**

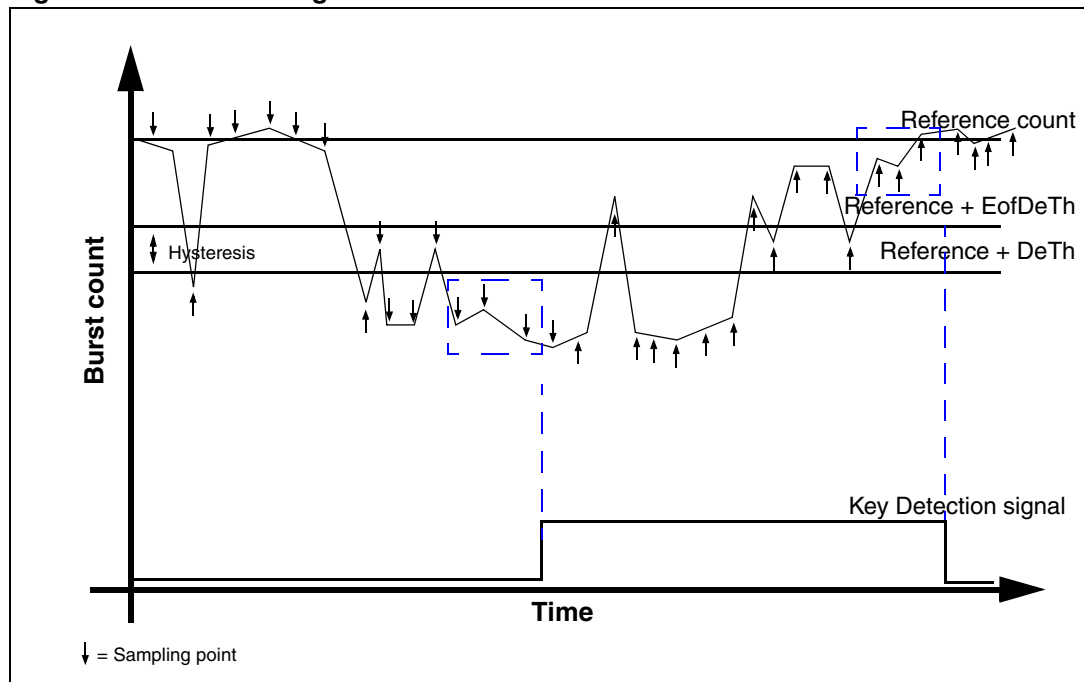

### 3.6 Self-calibration

On power-up, all keys are self-calibrated to provide reliable operation under almost any conditions. The calibration phase is used to compute a reference value per key which is then used by the process determining if a key is touched or not. The reference is an average of 8 single acquisitions. As a result, the calibration time of the system can be simply calculated using the following formula:  $t_{CAL} = 8 * Burst\_Period$ . The methodology used to measure the burst period is described in application note AN2547. For a maximum calibration duration ( $t_{CAL}$ ), please refer to [Section 6.6: Capacitive sensing characteristics on page 35](#).

### 3.7 Fast positive recalibration

The device autorecalibrates a key when its signal reflects a decrease in capacitance higher than a fixed threshold (PosRecalTh) for a defined number of acquisitions (PosRecall).

### 3.8 Forced key recalibration

A recalibration of the device may be issued at any time by sending to the QST device the appropriate I<sup>2</sup>C command or by tying the **RESET** pin to ground.

It is possible to recalibrate independently any individual key using an I<sup>2</sup>C command.

### 3.9 Max On-Duration

The device can time out and automatically recalibrate each key independently after a fixed duration of continuous touch detection. This prevents the keys from becoming 'stuck on' due to foreign objects or other sudden influences. This is known as the Max On-Duration feature.

After recalibration, the key will continue to operate normally, even if partially or fully obstructed. Max On-Duration works independently per channel: a timeout on one channel has no effect on another channel.

Infinite timeout is useful in applications where a prolonged detection can occur and where the output must reflect the detection no matter how long. In infinite timeout mode, the designer should take care to ensure that drift in  $C_S$ ,  $C_X$ , and  $V_{DD}$  do not cause the device to remain "stuck on" inadvertently even when the touching object is removed from the sense field. Timeout durations are not accurate and can vary substantially depending on  $V_{DD}$  and temperature values, and should not be relied upon for critical functions.

### 3.10 Drift compensation

Signal drift can occur because of changes in  $C_X$ ,  $C_S$ , and  $V_{DD}$  over time. Depending on the  $C_S$  type and quality, the signal may vary substantially with temperature and veiling. If keys are subject to extremes of temperature or humidity, the signal can also drift. It is crucial that drift be compensated, otherwise false detections, non detections, and sensitivity shifts will follow.

Drift compensation slowly corrects the reference level of each key while no detection is in effect. The rate of reference adjustment must be performed slowly or else legitimate detections can also be ignored. The device compensates drift on each channel independently using a maximum compensation rate to the reference level.

Once a touch is sensed, the drift compensation mechanism ceases since the signal is legitimately high, and therefore should not cause the reference level to change.

The signal drift compensation is "asymmetric": the reference level compensates drift in one direction faster than it does in the other. Specifically, it compensates faster for increasing signals than for decreasing signals. Decreasing signals should not be compensated for quickly, since an approaching finger could be compensated for partially or entirely while approaching the sense electrode. However, an obstruction over the sense pad, for which the sensor has already made full allowance, could suddenly be removed leaving the sensor with an artificially elevated reference level and thus become insensitive to touch. In this latter case, the sensor will compensate for the object's removal very quickly, usually in only a few seconds.

**Caution:** When only one key is enabled or if keys are very close together, the common drift compensation must be disabled or its rate must be reduced to ensure correct device operation.

Figure 4 illustrates an example of the drift compensation algorithm following a temperature change.

**Figure 4. Drift compensation example**

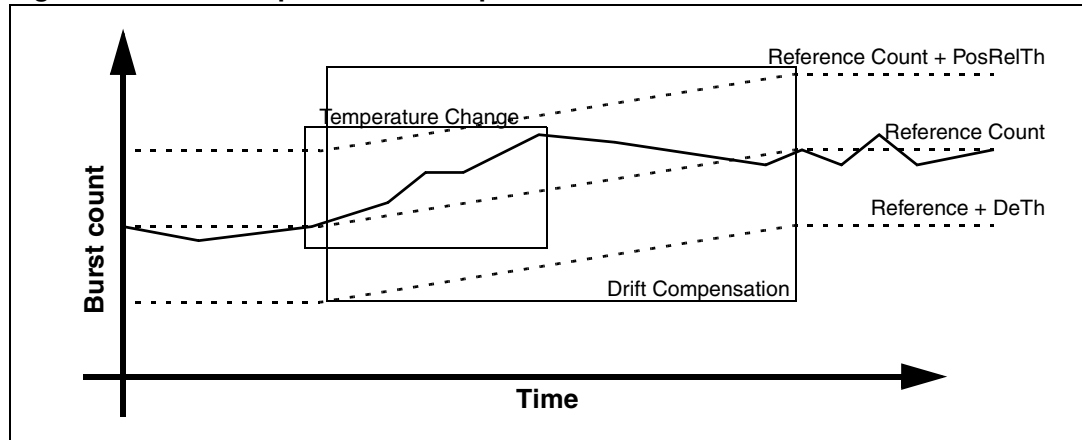

### 3.11 Adjacent key suppression (AKS™)

Adjacent key suppression (AKS™) is a Quantum-patented feature which prevents multiple keys from responding to a single touch. This can happen with closely spaced keys, or a scroll wheel that has buttons very near it.

The QST108 supports two AKS modes:

- **Locking AKS**  
Once a key is considered as “touched”, all other keys are locked in an untouched state. To unlock these keys, the touched key must return to an untouched state. Then, the key having the lowest key ID number is declared as the “touched” one.
- **Unlocking AKS**  
On each acquisition, the signal strengths from each key are compared and the key with the highest signal level is declared as the “touched” one.

In I<sup>2</sup>C mode, up to 8 AKS groups can be specified.

*Note: All keys belonging to the same AKS group must have the same AKS mode.*

## 4 Device operating modes

### 4.1 Reset and power-up

At power-up, the device configures itself according to the pull-up or pull-down option resistors present on pins OPT1 to OPT6. The device start-up and configuration may take up to  $t_{Setup}$ .

When the power is established, it is possible to force a new device configuration by applying a negative pulse on the  $\overline{RESET}$  pin.

The  $\overline{RESET}$  pin is a bidirectional pin with an internal pull-up. The line is forced low when the device resets itself (through an I<sup>2</sup>C command, for example).

A 10nF capacitor is recommended on the  $\overline{RESET}$  pin to ensure reliable start-up and noise immunity.

### 4.2 Burst operation

The device operates in "Burst" mode. Each key touch is acquired using a burst of charge-transfer sensing pulses whose count varies depending on the value of the sense capacitor  $C_S$  and the load capacitance  $C_X$ . Key touches are acquired using two successive bursts of pulses:

- Burst A: Keys 1, 2, 3, and 4
- Burst B: Keys 5, 6, 7, and 8

Bursts always operate in an A-B sequence. If Keys 5 to 8 are not implemented, the QST device will not perform the Burst B to improve the response time and reduce the power consumption when in Low Power (LP) mode.

In Low Power mode, the device sleeps in an ultra-low current state between bursts to conserve power.

### 4.3 Low power mode

In order to reduce the device power consumption, the QST family include scalable low power modes.

- Standard low power mode

When the device is in standard low power mode, a window with very low power consumption is inserted between the acquisition of the last active key and the following acquisition of the first active key.

This window duration is programmable as the 'sleep duration time'.

Note that the sleep window insertion is cancelled in the following conditions:

- If a change is detected on a key, in order to speed up the DI process, the sleep window insertion is skipped until the end of the DI process.
- In I<sup>2</sup>C mode, when a key change is actually detected and reported with a negative pulse on the  $\overline{IRQ}$  pin. In this case, the low power mode is disabled until a command is received from the host.
- Inside an I<sup>2</sup>C command, between the Write and the Read I<sup>2</sup>C frames, the sleep period is skipped.

- Free run in detect  
The behavior in this mode is the same as in the standard low power mode except that the sleep window insertion is always skipped if any of the active keys is detected as touched.  
This is useful to improve the wheel response time.
- Deep Sleep mode  
In Deep Sleep mode, the device enters a very low power mode indefinitely. The device resumes its operations after receiving an I<sup>2</sup>C frame with any address or a reset.

**Caution:** If an I<sup>2</sup>C frame is received while in Sleep or Deep Sleep mode, the device wakes up but does not acknowledge the frame (even if it has an I<sup>2</sup>C frame with the device address). The host must therefore send again the frame until it is taken in account and acknowledged.

### 4.4 Mode selection

The device options are configured by connecting pull-up or pull-down resistors on OPTn pins. The device operating mode is selected using option pin 1 (OPT1) while the device settings are configured using option pins OPT2 to OPT6 (Table 3). Option pins are sampled at power-up and after a reset.

To fit most applications, the QST108 device offers two different operating modes:

- Stand-alone mode  
This mode allows the user to simply replace existing mechanical switches with a capacitive sensing solution. It is designed for maximum flexibility and can accommodate most popular sensing requirements via option resistors (AKS, Low power, Max On-Duration and output modes).  
In this mode, the 8 output pins reflect the status of the 8 sensing channels.
- I<sup>2</sup>C mode  
In this mode, which is the most open one, the device is driven using the I<sup>2</sup>C interface. To avoid polling, the QST device features an output interrupt pin ( $\overline{IRQ}$ ). The  $\overline{IRQ}$  line reports all key changes to the Master device. The QST (Slave) device can drive up to five general-purpose outputs.

**Table 3. Operating modes**

OPT1: Mode selection		Option resistor function				
		OPT2	OPT3	OPT4	OPT5	OPT6
Pin OPT1 is high at start-up	Stand-alone mode	AKS	LP	MOD_0	MOD_1	OM
Pin OPT1 is low at start-up	I <sup>2</sup> C mode	ADD0	ADD1	ADD2	Unused	Unused

## 4.5 Stand-alone mode

This mode allows the user to simply replace existing mechanical switch interface with a capacitive sensing solution. It is designed for maximum flexibility and can accommodate most popular sensing requirements via option resistors (see [Figure 5](#)).

### 4.5.1 Main features

- Pins KOUT1 to KOUT8 directly reflect the state of keys
- Selectable global adjacent key suppression (AKS™)
- Selectable sleep duration
- Selectable Max On-Duration values
- Selectable BCD mode

**Figure 5. Stand-alone mode typical schematic**

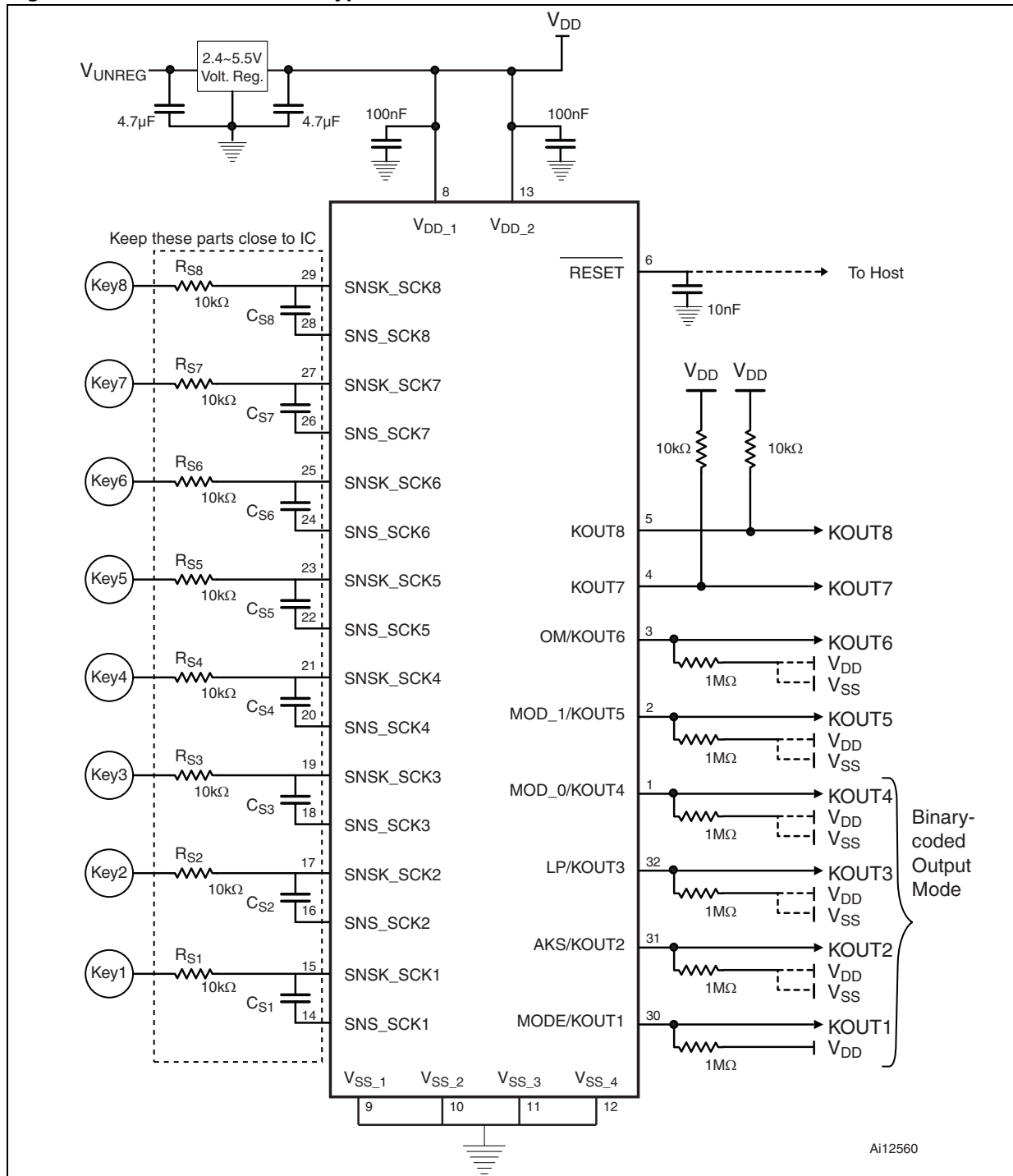

### 4.5.2 KOUT outputs

KOUTn outputs directly reflect the state of keys. These pins are push-pull outputs except for pins KOUT7 and KOUT8 which are true open-drain outputs. Under RESET, these pins are floating and their state depends on the option resistors. Pins KOUTn are active high meaning that when a key is “touched”, the corresponding KOUT pin outputs a ‘1’.



### 4.5.3 Option descriptions

#### Adjacent key suppression (AKS™)

The QST108 features an adjacent key suppression (AKS™) function.

This function is enabled using the AKS option resistor (OPT2) in standard output mode as described in [Table 4](#). In BCD output mode, the AKS function is always enabled, regardless of the option resistor configuration.

**Table 4. AKS truth table**

OPT2/AKS	Description
V <sub>SS</sub>	Disabled
V <sub>DD</sub>	Global locking AKS on all available keys

#### Low Power mode option

This option resistor (OPT3) selects whether the device is always sensing the keys or if a low power consumption phase is introduced between bursts as described in [Table 5](#).

In Low Power mode, a very low consumption (sleep) phase of 100ms is inserted between the Group B burst and the Group A burst. This significantly reduces the overall consumption of the device. Sleep duration is not accurate and can vary substantially depending on V<sub>DD</sub> and temperature values.

*Note:* In Low Power mode, the response time is increased.

**Table 5. Low power (LP) mode truth table**

OPT3/LP	Description
V <sub>SS</sub>	Free running mode
V <sub>DD</sub>	100ms sleep duration

#### Max On-Duration

There are four recalibration timing options (“Max On-Duration”). The recalibration option resistors (OPT4 and OPT5) control how long it takes for a continuous detection to trigger a recalibration on a key as described in [Table 6](#). When such an event occurs, only the “stuck” key is recalibrated.

**Table 6. Max On-Duration (MOD) truth table**

OPT4/MOD_0	OPT5/MOD_1	Description
V <sub>SS</sub>	V <sub>SS</sub>	Infinite
V <sub>SS</sub>	V <sub>DD</sub>	60s
V <sub>DD</sub>	V <sub>SS</sub>	20s
V <sub>DD</sub>	V <sub>DD</sub>	10s

**Output mode option**

The QST108 offers several outputs mode to fit any existing application.

**Table 7. Output mode (OM) truth table**

OPT6/OM	Description
V <sub>SS</sub>	Individual key state output mode: One output per sensing channel
V <sub>DD</sub>	BCD output mode: Binary-coded touched key number (see <a href="#">Table 8</a> ) <sup>(1)</sup>

1. In BCD mode, the AKS function must be enabled.

**Table 8. Binary code truth table**

KOUT4	KOUT3	KOUT2	KOUT1	Description
0	0	0	0	All released
0	0	0	1	Key 1 pressed
0	0	1	0	Key 2 pressed
0	0	1	1	Key 3 pressed
0	1	0	0	Key 4 pressed
0	1	0	1	Key 5 pressed
0	1	1	0	Key 6 pressed
0	1	1	1	Key 7 pressed
1	0	0	0	Key 8 pressed
Other				Not used

## 4.6 I<sup>2</sup>C mode

The I<sup>2</sup>C mode offers the largest configurability and functionality of the QST108.

### 4.6.1 Main features

- 5 general-purpose outputs
- Configuration of up to 8 AKS groups
- Additional low power modes
- Accessible internal capacitive sensing parameters
- Continuous range of Max On-Duration

Figure 6. I<sup>2</sup>C mode typical schematic

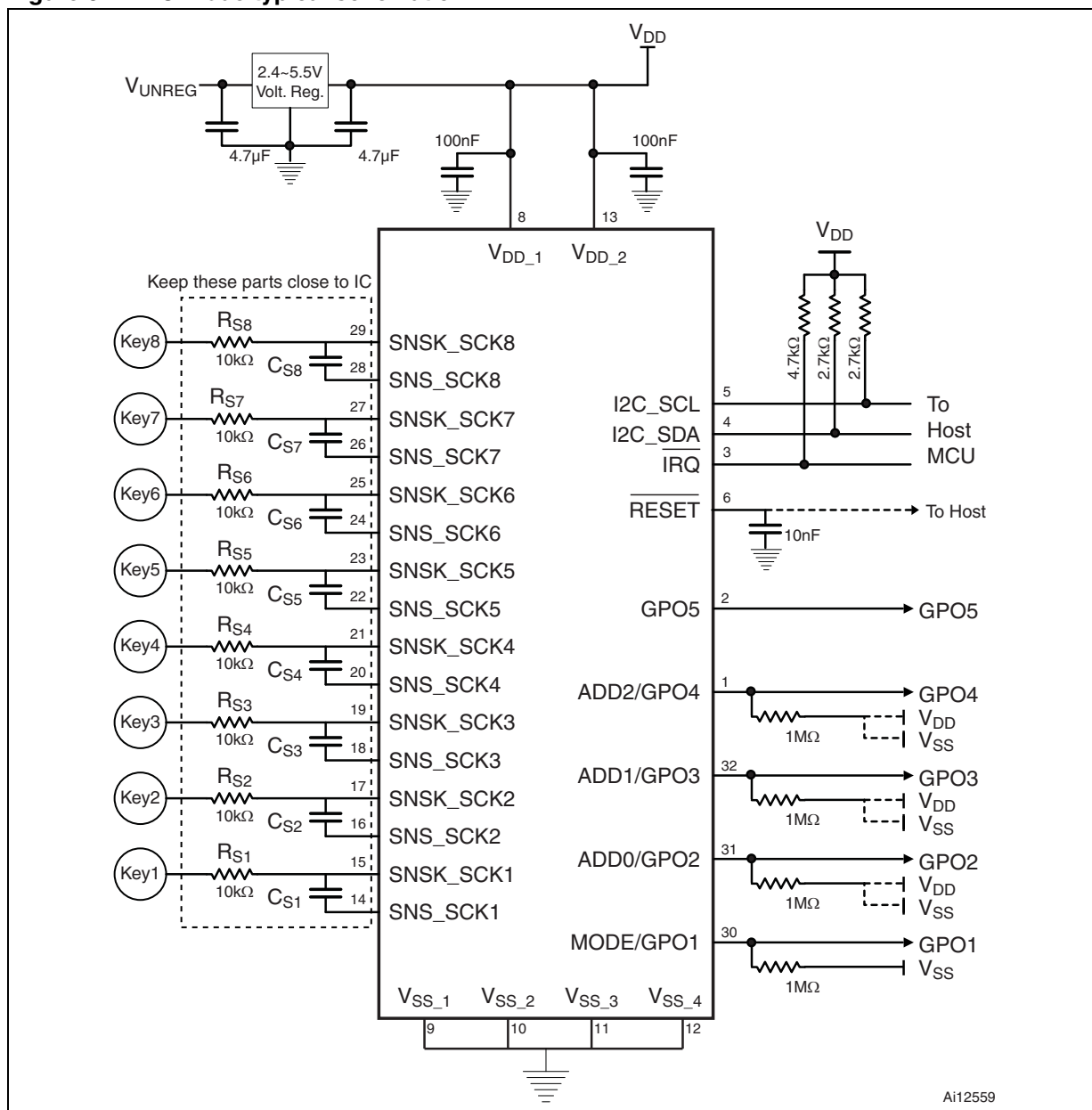

### 4.6.2 General-purpose outputs

I<sup>2</sup>C mode allows to drive up to 5 general-purpose outputs. These output pins are configured in output push pull mode 0 by default. Their state can be changed using the SET\_GPIO\_STATE I<sup>2</sup>C command.

**Figure 7. Optional LED schematic**

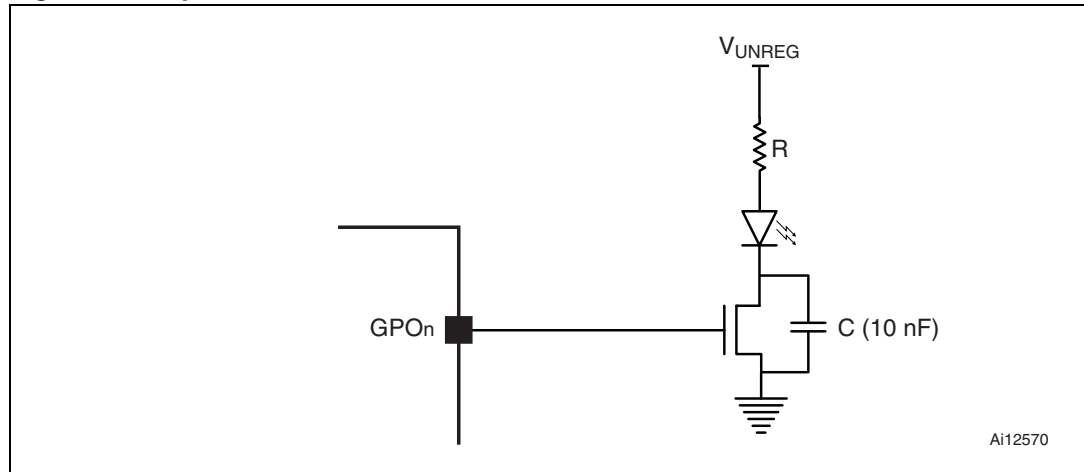

### 4.6.3 $\overline{\text{IRQ}}$ pin

The  $\overline{\text{IRQ}}$  pin is an open drain output with an internal pull-up. It can be used to inform the Master device about any change in the key status. The  $\overline{\text{IRQ}}$  line is pulled low every time the state of any of the enabled keys changes. This includes any change in the touch state of the key, a faulty key or a new calibration of one or more keys. The reported changes may then be accessed by the Master device by using the GET\_KEY\_STATE command.

To improve communication response time, this signal suspends Low Power mode until the Master device has issued a communication with the QST device.

### 4.6.4 Communication packet

The communication between the Master device and the QST108 (Slave) consists of two standard I<sup>2</sup>C frames.

The first frame is sent by the Master device using the QST108 device address with the write bit set. The data bytes consist of the command byte which is eventually followed by the parameters and a checksum byte.

The second one is sent by the Master device using the QST108 device address with the write bit reset. The QST108 completes the frame with data according to the command previously sent by the Master device. The device finishes the frame by sending a checksum byte for communication integrity verification.

If the read frame is omitted, the command may not be taken into account.

To initiate the communicate with the QST108, the Master device must send the GET\_DEVICE\_INFO command in order to unlock access to all the other commands.

## 4.6.5 I<sup>2</sup>C address selection

The QST108 slave address is programmable using the option resistors mapped on pins OPT2 to OPT4 (see [Table 9](#)).

**Table 9. I<sup>2</sup>C address versus option resistor**

Option configuration			I <sup>2</sup> C Address				
OPT4	OPT3	OPT2	ADD[6:3]	ADD2	ADD1	ADD0	Hex value
V <sub>SS</sub>	V <sub>SS</sub>	V <sub>SS</sub>	0101	0	0	0	0x28
V <sub>SS</sub>	V <sub>SS</sub>	V <sub>DD</sub>		0	0	1	0x29
V <sub>SS</sub>	V <sub>DD</sub>	V <sub>SS</sub>		0	1	0	0x2A
V <sub>SS</sub>	V <sub>DD</sub>	V <sub>DD</sub>		0	1	1	0x2B
V <sub>DD</sub>	V <sub>SS</sub>	V <sub>SS</sub>		1	0	0	0x2C
V <sub>DD</sub>	V <sub>SS</sub>	V <sub>DD</sub>		1	0	1	0x2D
V <sub>DD</sub>	V <sub>DD</sub>	V <sub>SS</sub>		1	1	0	0x2E
V <sub>DD</sub>	V <sub>DD</sub>	V <sub>DD</sub>		1	1	1	0x2F

## 4.7 Supported commands

[Table 10](#) lists the supported I<sup>2</sup>C commands and available arguments.

*Note:* For more information on the supported commands and I<sup>2</sup>C protocol, please refer to the QST standard communication protocol reference manual.

**Table 10. Supported commands**

I <sup>2</sup> C commands		Description
<b>CALIBRATE_KEY (All keys)</b>		
Write	0x98	Forces the recalibration of all keys.
Read	ErrCode	<i>ErrCode</i> : Standard Error code (see <a href="#">Table 11</a> )
<b>CALIBRATE_KEY (Single key)</b>		
Write	0x9B KeyID Checksum	Forces the recalibration of a single key.
Read	ErrCode	<i>KeyId</i> : Binary-coded key number (see <a href="#">Table 14</a> ) <i>ErrCode</i> : Standard Error code (see <a href="#">Table 11</a> )
<b>GET_DEBUG_INFO</b>		
Write	0xF7 KeyID Checksum	Returns the debug info of the single KeyID channel.
Read	0x0B KeyDbgState RefMSB RefLSB BCMSB BCLSB Checksum	<i>KeyDbgState</i> : Current Key Debug state (see <a href="#">Table 19</a> ) <i>RefMSB</i> : Reference Count MSB <i>RefLSB</i> : Reference Count LSB <i>BCMSB</i> : Burst Count MSB <i>BCLSB</i> : Burst Count LSB

**Table 10. Supported commands (continued)**

I <sup>2</sup> C commands		Description
<b>GET_DEVICE_INFO</b>		
Write	0x85	Returns the QST108 device version and ASCII-coded device name. This command must be sent first to enable the communication flow. <i>MainVers</i> : Device main version <i>SubVer</i> : Device sub-version <i>NbSCkey</i> : 0x08 single-channel keys <i>NbMCkey</i> : 0x00 multi-channel keys <b>Q S T 1 0 8</b> : ASCII-coded device name
Read	0x15 MainVers SubVers NbSCkey NbMCkey 'Q' 'S' 'T' '1' '0' '8' Checksum	
<b>GET_KEY_ERROR</b>		
Write	0xC4	Returns the error information on each key. <i>KeyErrorN</i> : KeyError byte description (see <a href="#">Table 12</a> )
Read	0x10 KeyError1 KeyError2 ... KeyError8 CheckSum	
<b>GET_KEY_STATE</b>		
Write	0xC1	Returns the state of all keys. <i>AllKeyState</i> : Touched/untouched state for all 8 keys. Refer to <a href="#">Table 13: AllKeyState</a> . <i>KeyError</i> : Refer to <a href="#">Table 12: KeyError byte description</a>
Read	0x04 AllKeyState KeyError Checksum	
<b>GET_PROTOCOL_VERSION</b>		
Write	0x80	Returns the QST108 protocol version. <i>MainVers</i> : Protocol main version <i>SubVer</i> : Protocol sub-version <i>I2CSpeed</i> : 0x00 (100 kHz maximum)
Read	0x07 MainVers SubVer I2CSpeed Checksum	
<b>RESET_DEVICE</b>		
Write	0xFD	Restarts the device (options Read and Calibration) after reading the ErrCode (see <a href="#">Table 11</a> ).
Read	ErrCode	
<b>SET_DETECT_INTEGRATORS</b>		
Write	0x03 0x04 0x00 DI EDI PosRecall CheckSum	Sets the detection, End Of Detection and Positive Recalibration Integrators for all keys. <i>DI</i> : Detection Integrator <sup>1) 3)</sup> <i>EDI</i> : End of Detection Integrator <sup>1) 3)</sup> <i>PosRecall</i> : Positive Recalibration Integrator <sup>1) 3)</sup> <i>ErrCode</i> : Standard Error code (see <a href="#">Table 11</a> )
Read	ErrCode	
<b>SET_GPIO_STATE</b>		
Write	0x08 0x01 GPOState Checksum	Controls the state of the general-purpose outputs. <i>GPOState</i> : State of general-purpose outputs (see <a href="#">Table 16</a> ) <i>ErrCode</i> : Standard Error code (see <a href="#">Table 11</a> )
Read	ErrCode	

Table 10. Supported commands (continued)

I <sup>2</sup> C commands		Description
<b>SET_KEY_ACTIVATION</b> (see Note 4)		
Write	0x97 KeyActivation Checksum	Enables or disables a single key. <i>KeyActivation</i> : Byte containing the key number selection and requested state.
Read	ErrCode	<i>ErrCode</i> : Standard Error code (see Table 11)
<b>SET_KEY_GROUP</b>		
Write	0x00 0x09 AKSGrpMode Key1Grp Key2Grp ...Key8Grp CheckSum	Defines the AKS groups for each key. <i>AKSGrpMode</i> : AKS mode selection of each group (see Table 17) <i>KeynGrp</i> : AKS group selection for key n (see Table 18)
Read	ErrCode	<i>ErrCode</i> : Standard Error code (see Table 11)
<b>SET_LOW_POWER_MODE</b>		
Write	0x92 LowPowerMode Checksum	Selects standard or Low Power mode. <i>LowPowerMode</i> : Configure Low Power mode (see Table 15)
Read	ErrCode	<i>ErrCode</i> : Standard Error code (see Table 11)
<b>SET_MAX_ON_DURATION</b>		
Write	0x8A MaxOnDuration Checksum	Sets the maximum detected ON time before triggering an automatic recalibration.
Read	ErrCode	<i>MaxOnDuration</i> : Time, in second (0 for infinite) <i>ErrCode</i> : Standard Error code (see Table 11)
<b>SET_SCKEY_PARAMETERS</b>		
Write	0x01 0x04 0x00 DeTh EofDeTh PosRecalTh Checksum	Sets the Detection, End Of Detection and Positive Recalibration Thresholds for a single key. <i>DeTh</i> : Detection Threshold <sup>1) 2)</sup> <i>EofDeTh</i> : End of Detection Threshold <sup>1) 2)</sup> <i>PosRecalTh</i> : Positive Recalibration Threshold <sup>1) 2)</sup>
Read	ErrCode	<i>ErrCode</i> : Standard Error code (see Table 11)

- Note:
- 1 See Section 6.6: Capacitive sensing characteristics on page 35 for default values.
  - 2 The value is a signed character (0x80...0x7F <=> -128 ... +128).
  - 3 The value is an unsigned number (0x01..0xFF <=> 1 ... 255).
  - 4 Enabling or disabling keys triggers a new calibration of all enabled keys.

**Error codes**

Table 11 lists the I<sup>2</sup>C error codes.

**Table 11. ErrCode**

ErrCode	Description
0x01	No Error
0x83	Command not supported
0x85	Parameter not supported
0xA1	Parity Error
0xA3	Checksum Error
0xE0	Initialization process (GET_FIRMWARE_INFO command not received)

**KeyError byte description**

**Table 12. KeyError byte description**

Bit 7	Bit 6	Bit 5	Bit 4	Bit 3	Bit 2	Bit 1	Bit 0
Key State	0	0	0	0	Key error codes		

**Key state (Bit 7)**

When set to '1', the corresponding key is touched. This bit is always cleared for the GET\_KEY\_STATE command.

**Key error codes (Bits 2:0)**

When answering the GET\_KEY\_STATE command, the key error code corresponds to the error codes of all the keys ORed together. When answering the GET\_KEY\_ERROR command, each key error code describes the errors of one defined key.

- Bit 0: When set to '1', calibration in progress
- Bit 1: When set to '1', maximum count reached
- Bit 2: When set to '1', minimum count not reached

**All key state description**

**Table 13. AllKeyState**

Bit 7	Bit 6	Bit 5	Bit 4	Bit 3	Bit 2	Bit 1	Bit 0
Key 8 State	Key 7 State	Key 6 State	Key 5 State	Key 4 State	Key 3 State	Key 2 State	Key 1 State

**Key n state**

When set to '1', the corresponding key is touched.



**Key activation description**

**Table 14. KeyActivation**

Bit 7	Bit 6	Bit 5	Bit 4	Bit 3	Bit 2	Bit 1	Bit 0
Key Activation	0	0	0	Key ID (binary coded)			

**Key activation (Bit 7)**

- 0: Key disabled
- 1: Key enabled

**Key identifier (Bits 3:0)**

- 0000: All keys
- 0001: Key 1
- 0010: Key 2
- 0011: Key 3
- 0100: Key 4
- 0101: Key 5
- 0110: Key 6
- 0111: Key 7
- 1000: Key 8

**Low power mode description**

**Table 15. SetLowPower**

Bit 7	Bit 6	Bit 5	Bit 4	Bit 3	Bit 2	Bit 1	Bit 0
0	Free Run in Detect	Sleep Duration Factor					

**Free Run in Detect (Bit 6)**

- 0: Low Power mode is always enabled, whatever the state of the keys.
- 1: Low Power mode is automatically suspended when any key is in Detect state. Low Power mode is automatically resumed when no key is in Detect state.

**Sleep Duration Factor (Bits 5 to 0)**

- 0x00 or 0x1A to 0x3E: Low power mode is disabled.
- 0x01 to 0x19: Low Power mode. The sleep duration is 'Sleep Duration Factor' x 20 milliseconds (20 ms to 500 ms)
- 0x3F: Deep Sleep mode is entered immediately. A reset or any I2C communication can be used to exit Deep Sleep mode.

*Note: When the device is in Sleep or Deep Sleep, any I<sup>2</sup>C bus activity will wake-up the device. The I<sup>2</sup>C QST device address is not acknowledged but forces the QST device to exit from Low Power mode. The Master device will have to repeat the command to ensure that it is taken in account.*

## GPO state description

**Table 16. GPOState**

Bit 7	Bit 6	Bit 5	Bit 4	Bit 3	Bit 2	Bit 1	Bit 0
0	0	0	GPO 5 state	GPO 4 state	GPO 3 state	GPO 2 state	GPO 1 state

### GPOState

Defines the state of the selected general-purpose output pin. For more information, see [Section 4.6.2: General-purpose outputs on page 20](#).

- 0: GPO state is '0'
- 1: GPO state is '1'

## AKS group mode description

**Table 17. AKSGrpnMode**

Bit 7	Bit 6	Bit 5	Bit 4	Bit 3	Bit 2	Bit 1	Bit 0
AKSGrp8 Mode	AKSGrp7 Mode	AKSGrp6 Mode	AKSGrp5 Mode	AKSGrp4 Mode	AKSGrp3 Mode	AKSGrp2 Mode	AKSGrp1 Mode

### AKSGrpnMode

Defines the type of AKS for the Group n:

- 0: Locking AKS: First key pressed within the group locks out all other keys.
- 1: Unlocking AKS: Most heavily pressed key (highest signal level) is selected over all other keys in the group.

## AKS group selection description

**Table 18. KeynGrp**

Bit 7	Bit 6	Bit 5	Bit 4	Bit 3	Bit 2	Bit 1	Bit 0
Grp8	Grp7	Grp6	Grp5	Grp4	Grp3	Grp2	Grp1

### Grpx

The selected key is a member of AKS Group x.

## Key debug state description

**Table 19. KeyDbgState**

Value	Description
0x01	On-going calibration
0x02	Key released
0x04	Key touched
0x08	Key in error
0x11	Key calibration filter triggered (PosRecall)
0x14	Key detection filter triggered (DI)
0x24	Key end of detection filter triggered (EDI)

## 5 Design guidelines

### 5.1 $C_S$ sense capacitor

The  $C_S$  sense capacitors accumulate the charge from the key electrodes and determine sensitivity. Higher values of  $C_S$  make the corresponding sensing channel more sensitive. The values of  $C_S$  can differ for each channel, permitting differences in sensitivity from key to key or to balance unequal sensitivities. Unequal sensitivities can occur due to key size and placement differences and stray wiring capacitances. More stray capacitance on a sense trace will desensitize the corresponding key. Increasing the  $C_S$  for that key will compensate for the loss of sensitivity.

The  $C_S$  capacitors can be virtually any plastic film or low- to medium-K ceramic capacitor. The normal  $C_S$  range is 1nF to 50nF depending on the sensitivity required: larger values of  $C_S$  require better quality to ensure reliable sensing. In certain circumstances the normal  $C_S$  range may be exceeded. Acceptable capacitor types for most uses include PPS film, polypropylene film, and NP0 and X5R / X7R ceramics. Lower grades than X5R or X7R are not recommended.

### 5.2 Sensitivity tuning

Sensitivity can be altered to suit various applications and situations on a channel-by-channel basis. The easiest and most direct way to impact sensitivity is to alter the value of each  $C_S$ : more  $C_S$  yields higher sensitivity. Each channel has its own  $C_S$  value and can therefore be independently adjusted.

#### 5.2.1 Increasing sensitivity

Sensitivity can also be increased by using larger electrode areas, reducing panel thickness, or using a panel material with a higher dielectric constant.

#### 5.2.2 Decreasing sensitivity

In some cases the circuit may be too sensitive. Gain can be lowered further by a number of strategies:

- making the electrode smaller
- making the electrode into a sparse mesh using a high space-to-conductor ratio
- decreasing the  $C_S$  capacitors

#### 5.2.3 Key balance

A number of factors can cause sensitivity imbalances. Notably, SNS wiring to electrodes can have differing stray amounts of capacitance to ground. Increasing load capacitance will cause a decrease in gain. Key size differences, and proximity to other metal surfaces can also impact gain.

The keys may thus require “balancing” to achieve similar sensitivity levels. This can be best accomplished by trimming the values of the  $C_S$  capacitors to achieve equilibrium. The  $R_S$  resistors have no effect on sensitivity and should not be altered. Load capacitances to ground can also be added to overly sensitive channels to reduce their gain.

These should be in the order of a few picofarads.

### 5.3 Power supply

If the power supply fluctuates slowly with temperature, the QST device compensates automatically for these changes with only minor changes in sensitivity. However, if the supply voltage drifts or shifts quickly, the drift compensation mechanism is not able to keep up, causing sensitivity anomalies or false detections.

The power supply should be locally regulated, using a three-terminal regulator. If the supply is shared with another electronic system, care should be taken to ensure that the supply is free of digital spikes, sags and surges which can cause adverse effects. It is not recommended to include a series inductor in the power supply to the QST device.

For proper operation, a 0.1  $\mu\text{F}$  or greater bypass capacitor must be used between  $V_{\text{DD}}$  and  $V_{\text{SS}}$ . The bypass capacitor should be routed with very short tracks to the device's  $V_{\text{DD}}$  and  $V_{\text{SS}}$  pins.

The PCB should, if possible, include a copper pour under and around the device, but not extensively under the SNS lines.

### 5.4 ESD protection

In normal environmental conditions, only one series resistor is required for ESD suppression. A 10 k $\Omega$   $R_{\text{S}}$  resistor in series with the sense trace is sufficient in most cases. The dielectric panel (glass or plastic) usually provides a high degree of isolation to prevent ESD discharge from reaching the circuit.  $R_{\text{S}}$  should be placed close to the chip. If the  $C_{\text{X}}$  load is high,  $R_{\text{S}}$  can prevent total charge and transfer and as a result gain can deteriorate. If a reduction in  $R_{\text{S}}$  increases gain noticeably, the lower value should be used. Conversely, increasing the  $R_{\text{S}}$  can result in added ESD and EMC benefits, provided that the increase does not decrease sensitivity.

### 5.5 Crosstalk precautions

Adjacent sense traces might require intervening ground traces in order to reduce capacitive cross bleed if high sensitivity is required or high values of  $\Delta C_{\text{X}}$  are anticipated (for example, from direct human touch to an electrode connection). In normal touch applications behind plastic panels, this is rarely a problem regardless of how the electrodes are wired.

Higher values of  $R_{\text{S}}$  will make crosstalk problems worse; try to keep  $R_{\text{S}}$  to 22 k $\Omega$  or less if possible. In general try to keep the QST device close to the electrodes and reduce the adjacency of the sense wiring to ground planes and other signal traces; this will reduce the  $C_{\text{X}}$  load, reduce interference effects, and increase signal gain. The one and only valid reason to run ground near SNS traces is to provide crosstalk isolation between traces, and then only on an as-needed basis.

### 5.6 PCB layout and construction

The PCB traces, wiring, and any components associated with or in contact with either SNS pin will become touch sensitive and should be treated with caution to limit the touch area to the desired location.

Multiple touch electrodes connected to any sensing channel can be used, for example, to create control surfaces on both sides of an object.

It is important to limit the amount of stray capacitance on the SNS terminals, for example by minimizing trace lengths and widths to allow for higher gain without requiring higher values of  $C_S$ . Under heavy  $\Delta C_X$  loading of one key, cross coupling to another key's trace can cause the other key to trigger. Therefore, electrode traces from adjacent keys should not be run close to each other over long runs in order to minimize cross-coupling if large values of  $\Delta C_X$  are expected, for example when an electrode is directly touched. This is not a problem when the electrodes are working through a plastic panel with normal touch sensitivity.

For additional information on PCB layout and construction, please contact your local ST Sales Office for a list of available application notes.

## 6 Electrical characteristics

### 6.1 Parameter conditions

Unless otherwise specified, all voltages are referred to  $V_{SS}$ .

#### 6.1.1 Minimum and maximum values

Unless otherwise specified the minimum and maximum values are guaranteed in the worst conditions of ambient temperature, supply voltage and frequencies by tests in production on 100% of the devices with an ambient temperature at  $T_A = 25^\circ\text{C}$  and  $T_A = T_{A\text{max}}$  (given by the selected temperature range).

Data based on characterization results, design simulation and/or technology characteristics are indicated in the table footnotes and are not tested in production. Based on characterization, the minimum and maximum values refer to sample tests and represent the mean value plus or minus three times the standard deviation ( $\text{mean} \pm 3\Sigma$ ).

#### 6.1.2 Typical values

Unless otherwise specified, typical data are based on  $T_A = 25^\circ\text{C}$ ,  $V_{DD} = 5\text{ V}$  (for the  $4.5\text{ V} \leq V_{DD} \leq 5.5\text{ V}$  voltage range) and  $V_{DD} = 3.3\text{ V}$  (for the  $3.0\text{ V} \leq V_{DD} \leq 3.6\text{ V}$  voltage range). They are given only as design guidelines and are not tested.

#### 6.1.3 Typical curves

Unless otherwise specified, all typical curves are given only as design guidelines and are not tested.

#### 6.1.4 Loading capacitor

The loading conditions used for pin parameter measurement are shown in [Figure 8](#).

**Figure 8. Pin loading conditions**

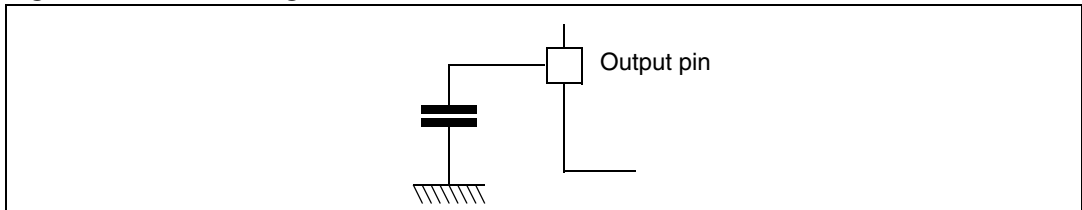

#### 6.1.5 Pin input voltage

The input voltage measurement on a pin of the device is described in [Figure 9](#).

**Figure 9. Pin input voltage**

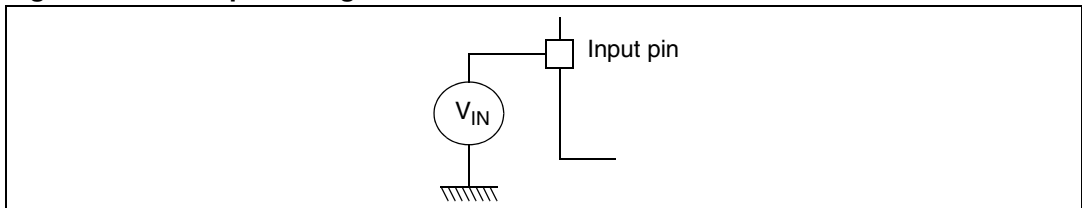

## 6.2 Absolute maximum ratings

Stresses above those listed as “absolute maximum ratings” may cause permanent damage to the device. This is a stress rating only and functional operation of the device under these conditions is not implied. Exposure to maximum rating conditions for extended periods may affect device reliability.

**Table 20. Thermal characteristics**

Symbol	Ratings	Value	Unit
$T_{STG}$	Storage temperature range	-65 to +150	°C
$T_J$	Maximum junction temperature		

**Table 21. Voltage characteristics**

Symbol	Ratings	Maximum value	Unit
$V_{DD} - V_{SS}$	Supply voltage	7.0	V
$V_{IN}$	Input voltage on any pin <sup>(1)(2)</sup>	$V_{SS} - 0.3$ to $V_{DD} + 0.3$	

1. Directly connecting the  $\overline{RESET}$  and I/O pins to  $V_{DD}$  or  $V_{SS}$  could damage the device if an unintentional internal reset is generated or an unexpected change of the I/O configuration occurs. To guarantee safe operation, this connection has to be done through a pull-up or pull-down resistor (typical: 4.7k $\Omega$  for  $\overline{RESET}$ , 10k $\Omega$  for I/Os).
2.  $I_{INJ(PIN)}$  must never be exceeded. This is implicitly insured if  $V_{IN}$  maximum is respected. If  $V_{IN}$  maximum cannot be respected, the injection current must be limited externally to the  $I_{INJ(PIN)}$  value. A positive injection is induced by  $V_{IN} > V_{DD}$  while a negative injection is induced by  $V_{IN} < V_{SS}$ . For true open-drain pads, there is no positive injection current, and the corresponding  $V_{IN}$  maximum must always be respected.

**Table 22. Current characteristics**

Symbol	Ratings	Maximum value	Unit
$I_{VDD}$	Total current into $V_{DD}$ power lines (source) <sup>(1)</sup>	75	mA
$I_{VSS}$	Total current out of $V_{SS}$ ground lines (sink) <sup>(1)</sup>	150	
$I_{IO}$	Output current sunk by $\overline{RESET}$ pin	20	
	Output current sunk by output pin	40	
	Output current source by output pin	- 25	
$I_{INJ(PIN)}^{(2)(3)}$	Injected current on $\overline{RESET}$ pin	$\pm 5$	
	Injected current output pin	$\pm 5$	
$\Sigma I_{INJ(PIN)}^{(2)}$	Total injected current (sum of all I/O and control pins)	$\pm 20$	

1. All power ( $V_{DD}$ ) and ground ( $V_{SS}$ ) lines must always be connected to the external supply.
2.  $I_{INJ(PIN)}$  must never be exceeded. This is implicitly ensured if  $V_{IN}$  maximum is respected. If  $V_{IN}$  maximum cannot be respected, the injection current must be limited externally to the  $I_{INJ(PIN)}$  value. A positive injection is induced by  $V_{IN} > V_{DD}$  while a negative injection is induced by  $V_{IN} < V_{SS}$ . For true open-drain pads, there is no positive injection current, and the corresponding  $V_{IN}$  maximum must always be respected.
3. When several inputs are submitted to a current injection, the maximum  $\Sigma I_{INJ(PIN)}$  is the absolute sum of the positive and negative injected currents (instantaneous values). These results are based on characterisation with  $\Sigma I_{INJ(PIN)}$  maximum current injection on four KOUT pins of the device.

### 6.3 EMC characteristics

Susceptibility tests are performed on a sample basis during product characterization.

#### 6.3.1 Functional EMS (electro magnetic susceptibility)

The product is stressed by two electro magnetic events until a failure occurs:

- **ESD:** Electro-Static Discharge (positive and negative) is applied on all pins of the device until a functional disturbance occurs. This test conforms with the IEC 1000-4-2 standard.
- **FTB:** A Burst of Fast Transient voltage (positive and negative) is applied to  $V_{DD}$  and  $V_{SS}$  through a 100pF capacitor, until a functional disturbance occurs. This test conforms with the IEC 1000-4-4 standard.

A device reset allows normal operations to be resumed. The test results are given in the table below based on the EMS levels and classes defined in application note AN1709.

**Table 23. Functional EMS**

Symbol	Parameter	Conditions	Level/Class
$V_{FESD}$	Voltage limits to be applied on any I/O pin to induce a functional disturbance	$V_{DD}=5V, T_A=+25^{\circ}C$ , complies with IEC 1000-4-2	3B
$V_{FFTB}$	Fast transient voltage burst limits to be applied through 100pF on $V_{DD}$ and $V_{DD}$ pins to induce a functional disturbance	$V_{DD}=5V, T_A=+25^{\circ}C$ complies with IEC 1000-4-4	4A

#### 6.3.2 Electro magnetic interference (EMI)

The product is monitored in terms of emission. This emission test is in line with the norm SAE J 1752/3 which specifies the board and the loading of each pin.

**Table 24. EM emissions**

Symbol	Parameter	Conditions	Monitored Frequency Band	$f_{DEVICE} = 4 \text{ MHz}^{(1)}$	Unit
$S_{EMI}$	Peak level	$V_{DD}=5V, T_A=+25^{\circ}C$ , complies with SAE J 1752/3	0.1 MHz to 30 MHz	20	dB $\mu$ V
			30 MHz to 130 MHz	20	
			130 MHz to 1 GHz	13	
			SAE EMI Level	2.5	-

1. Data based on characterization results, not tested in production.



### 6.3.3 Absolute maximum ratings (electrical sensitivity)

Based on three different tests (ESD, LU and DLU) using specific measurement methods, the product is stressed in order to determine its performance in terms of electrical sensitivity. For more details, refer to the application note AN1181.

#### Electro-static discharge (ESD)

Electro-Static Discharges (a positive then a negative pulse separated by 1 second) are applied to the pins of each sample according to each pin combination. The sample size depends on the number of supply pins in the device (3 parts\*(n+1) supply pin). Two models can be simulated: Human Body Model and Charge Device Model. These tests comply with JESD22-A114A/A115A specifications.

**Table 25. Absolute maximum ratings**

Symbol	Ratings	Conditions	Maximum value <sup>(1)</sup>	Unit
V <sub>ESD(HBM)</sub>	Electro-static discharge voltage (Human Body Model)	T <sub>A</sub> =+25°C	4000	V
V <sub>ESD(CDM)</sub>	Electro-static discharge voltage (Charge Device Model)	T <sub>A</sub> =+25°C	500	V

1. Data based on characterization results, not tested in production.

#### Static and dynamic latch-up

- **LU:** 3 complementary static tests are required on 10 parts to assess the latch-up performance. A supply overvoltage (applied to each power supply pin) and a current injection (applied to each I/O pin) are performed on each sample. This test complies with EIA/JESD 78 IC latch-up specifications.
- **DLU:** Electro-Static Discharges (one positive then one negative test) are applied to each pin of 3 samples when the MCU is running to assess the latch-up performance in Dynamic mode. Power supplies are set to the typical values and the component is put in Reset mode. This test complies with IEC1000-4-2 and SAEJ1752/3 specifications.

For more details, refer to the application note AN1181.

**Table 26. Electrical sensitivities**

Symbol	Parameter	Conditions	Class <sup>(1)</sup>
LU	Static latch-up class	T <sub>A</sub> =+125°C	A
DLU	Dynamic latch-up class	V <sub>DD</sub> =5.5V, f <sub>DEVICE</sub> = 4MHz, T <sub>A</sub> =+25°C	A

1. Class description: A Class is an STMicroelectronics internal specification. All its limits are higher than the JEDEC specifications, that means when a device belongs to Class A it exceeds the JEDEC standard. B Class strictly covers all the JEDEC criteria (international standard).

## 6.4 Operating conditions

**Table 27. Operating conditions**

Symbol	Feature	Value	Unit
$V_{DD}$	Operating supply voltage	2.4 to 5.5	V
$T_A$	Operating temperature	-40° to +85°	C

## 6.5 Supply current characteristics

**Table 28. Supply current characteristics**

Symbol	Parameter	Conditions	Min.	Typ. <sup>(1)</sup>	Max.	Unit
$I_{DD}$ (FR)	Average supply current Free Run mode	$V_{DD} = 2.4\text{ V}$		1.71		mA
		$V_{DD} = 3.3\text{ V}$		2.17		
		$V_{DD} = 5\text{ V}$		3.35		
$I_{DD}$ (Sleep 100ms)	Average supply current 100ms Sleep mode	$V_{DD} = 2.4\text{ V}$		276		$\mu\text{A}$
		$V_{DD} = 3.3\text{ V}$		389		
		$V_{DD} = 5\text{ V}$		637		
$I_{DD}$ (Sleep 500ms)	Average supply current 500ms Sleep mode	$V_{DD} = 2.4\text{ V}$		108		$\mu\text{A}$
		$V_{DD} = 3.3\text{ V}$		144		
		$V_{DD} = 5\text{ V}$		246		
$I_{DD}$ Deep Sleep	Average supply current Deep Sleep mode				5	$\mu\text{A}$

1. The results are based on  $C_S = 2.7\text{nF}$  and  $C_X = 12.5\text{pF}$

**Figure 10.  $I_{DD}$  Sleep mode current characteristics**

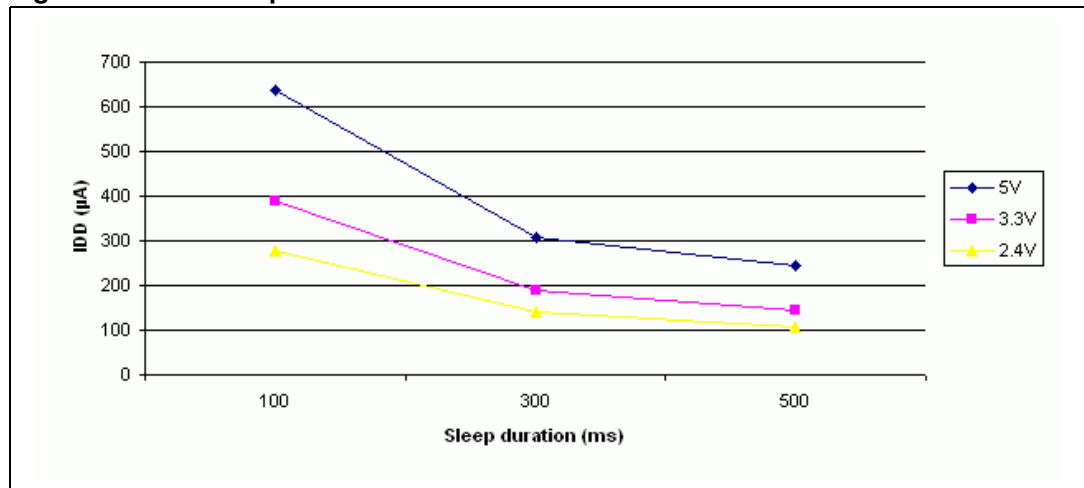

## 6.6 Capacitive sensing characteristics

**Table 29. External sensing components**

Symbol	Parameter	Min.	Typ.	Max.	Unit
C <sub>S</sub>	Sense capacitor			100	nF
C <sub>X</sub>	Equivalent electrode capacitor			100	pF
C <sub>T</sub>	Equivalent touch capacitor		5		pF
R <sub>S</sub>	Serial resistor		10	22	kOhm

**Table 30. Capacitive sensing parameters**

Symbol	Parameter	Min.	Default	Max.	Unit
t <sub>CAL</sub>	Calibration duration			2	s
t <sub>Setup</sub>	Setup duration		100		ms
DI	Detection integrator	1	2	255	Samples
DeTh	Detection threshold	-128	-10	-1	Counts
EDI	End of detection integrator	1	2	255	Samples
EofDeTh	End of detection threshold	-128	-6	-1	Counts
PosRecall	Positive recalibration integrator	1	2	255	Samples
PosRecalTh	Positive recalibration threshold	1	15	127	Counts
MaxOnDuration	Max on-duration delay	1	Infinite	255	s
PosDiffDrift	Positive differential drift compensation rate	0.1	1	25.5	s/level
NegDiffDrift	Negative differential drift compensation rate	0.1	1	25.5	s/level
PosComDrift	Positive common drift compensation rate	0.1	0.2	25.5	s/level
NegComDrift	Negative common drift compensation rate	0.1	0.2	25.5	s/level
PosDriftI	Positive drift integrator	0	10	255	
NegDriftI	Negative drift integrator	0	10	255	
ComFact	Common time step factor	0	2	255	
DiffFact	Differential time step factor	0	10	255	
BurstCount	Burst length	20		2000	Counts

## 6.7 KOUTn/OPTn/GPOn pin characteristics

### 6.7.1 General characteristics

Subject to general operating conditions for  $V_{DD}$  and  $T_A$  unless otherwise specified.

**Table 31. General characteristics**

Symbol	Parameter	Conditions	Min.	Typ.	Max.	Unit
$V_{IL}$	Input low level voltage <sup>(1)</sup>		$V_{SS} - 0.3$		$0.3 \times V_{DD}$	V
$V_{IH}$	Input high level voltage <sup>(1)</sup>		$0.7 \times V_{DD}$		$V_{DD} + 0.3$	
$V_{Hys}$	Schmitt trigger voltage hysteresis <sup>(2)</sup>			400		mV
$I_L$	Input leakage current	$V_{SS} \leq V_{IN} \leq V_{DD}$			$\pm 1$	$\mu A$
$C_{IO}$	I/O pin capacitance			5		pF
$t_{f(I/O)out}$	Output high to low level fall time <sup>(2)</sup>	$C_L = 50 \text{ pF}$ Between 10% and 90%		25		ns
$t_{r(I/O)out}$	Output low to high level rise time <sup>(2)</sup>			25		

1. Not tested in production, guaranteed by characterization.
2. Data based on validation/design results.

### 6.7.2 Output pin characteristics

Subject to general operating conditions for  $V_{DD}$ ,  $f_{CPU}$ , and  $T_A$  unless otherwise specified.

**Table 32. Output pin current**

Symbol	Parameter	Conditions	Min.	Max.	Unit
$V_{OL}^{(1)}$	Output low level voltage for a high sink I/O pin when 4 pins are sunk at same time <i>(Figure 16)</i>	$V_{DD} = 5V$ $I_{IO} = +20mA$		1.3	V
		$I_{IO} = +8mA$		0.75	
$V_{OH}^{(2)}$	Output high level voltage for an I/O pin when 4 pins are sourced at same time <i>(Figure 21)</i>	$V_{DD} = 5V$ $I_{IO} = -5mA$	$V_{DD} - 1.5$		
		$I_{IO} = -2mA$	$V_{DD} - 0.8$		
$V_{OL}^{(1)(3)}$	Output low level voltage for a high sink I/O pin when 4 pins are sunk at same time	$V_{DD} = 3.3V$ $I_{IO} = +8mA$		0.5	
$V_{OH}^{(2)(3)}$	Output high level voltage for an I/O pin when 4 pins are sourced at same time <i>(Figure 19)</i>	$V_{DD} = 3.3V$ $I_{IO} = -2mA$	$V_{DD} - 0.8$		
$V_{OL}^{(1)(3)}$	Output low level voltage for a high sink I/O pin when 4 pins are sunk at same time	$V_{DD} = 2.4V$ $I_{IO} = +8mA$		0.6	
$V_{OH}^{(2)(3)}$	Output high level voltage for an I/O pin when 4 pins are sourced at same time	$V_{DD} = 2.4V$ $I_{IO} = -2mA$	$V_{DD} - 0.9$		

1. The  $I_{IO}$  current sunk must always respect the absolute maximum rating specified in [Table 22](#) and the sum of  $I_{IO}$  (I/O ports and control pins) must not exceed  $I_{VSS}$ .
2. The  $I_{IO}$  current sourced must always respect the absolute maximum rating specified in [Table 22](#) and the sum of  $I_{IO}$  (output and RESET pins) must not exceed  $I_{VDD}$ .
3. Not tested in production, based on characterization results.

Figure 11. Typical  $V_{OL}$  at  $V_{DD} = 2.4\text{ V}$

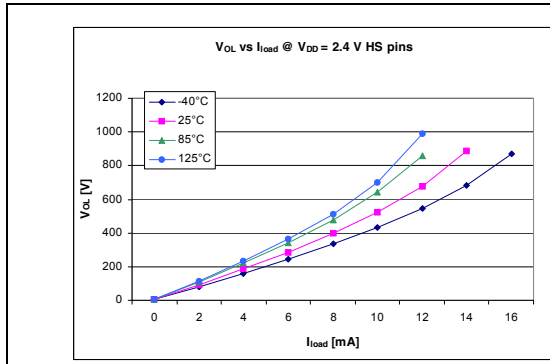

Figure 12. Typical  $V_{OL}$  vs  $V_{DD}$  at  $I_{load} = 2\text{ mA}$

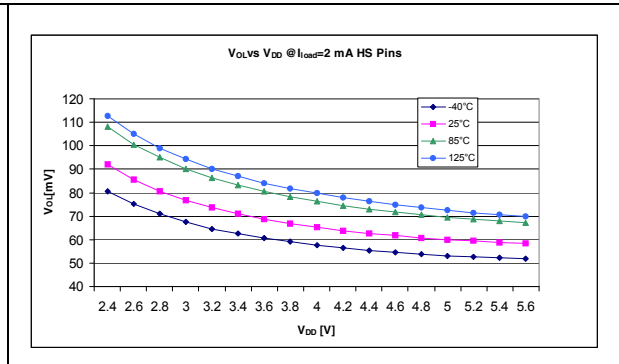

Figure 13. Typical  $V_{OL}$  at  $V_{DD} = 3\text{ V}$

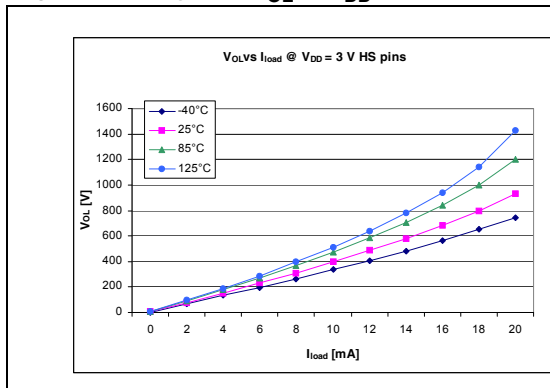

Figure 14. Typical  $V_{OL}$  vs  $V_{DD}$  at  $I_{load} = 8\text{ mA}$

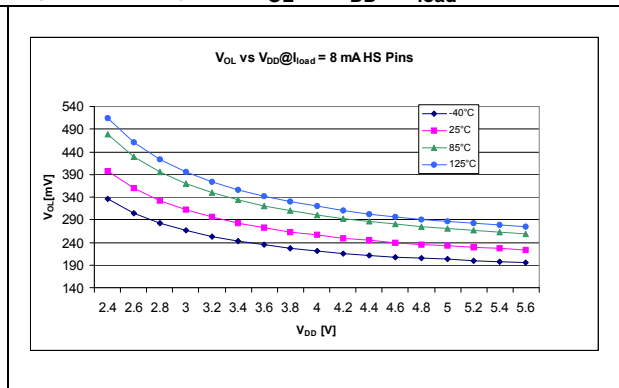

Figure 15. Typical  $V_{OL}$  at  $V_{DD} = 5\text{ V}$

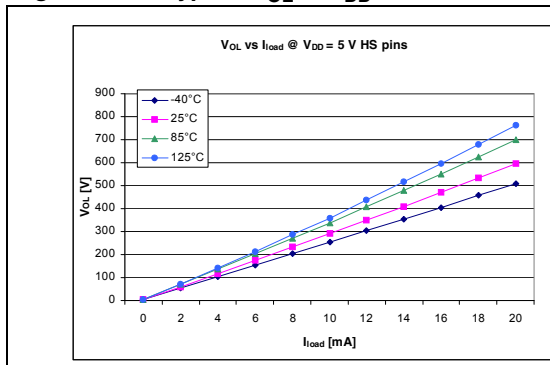

Figure 16. Typical  $V_{OL}$  vs  $V_{DD}$  at  $I_{load} = 12\text{ mA}$

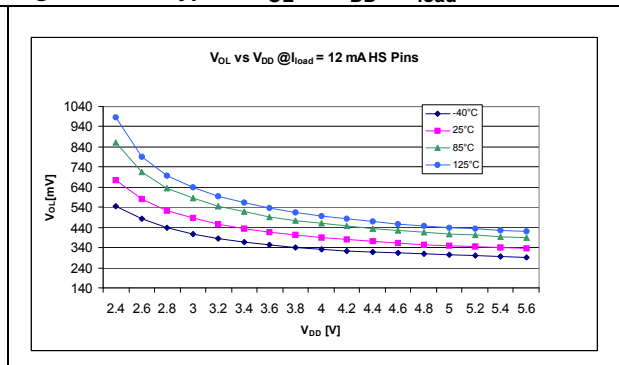

Figure 17. Typical  $V_{DD}-V_{OH}$  vs.  $I_{load}$  at  $V_{DD} = 2.4\text{ V}$

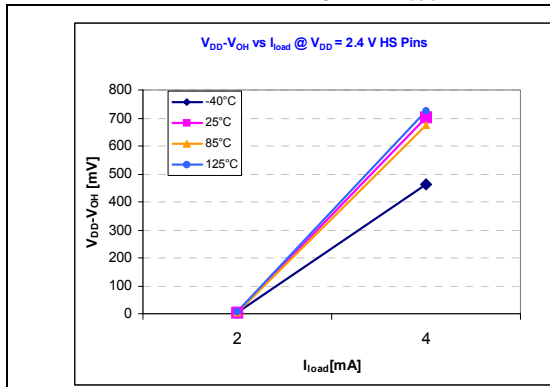

Figure 18. Typical  $V_{DD}-V_{OH}$  vs.  $V_{DD}$  at  $I_{load} = 2\text{ mA}$

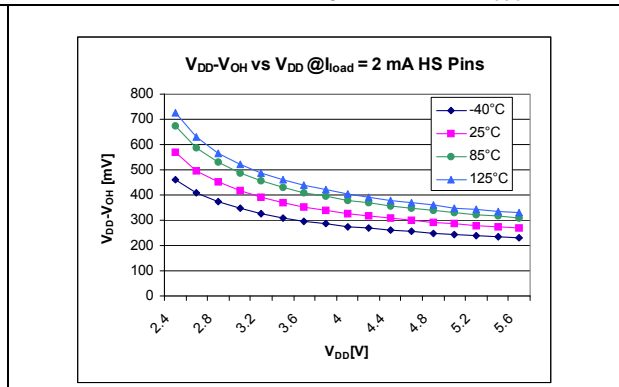

Figure 19. Typical  $V_{DD}-V_{OH}$  vs.  $I_{load}$  at  $V_{DD} = 3\text{ V}$

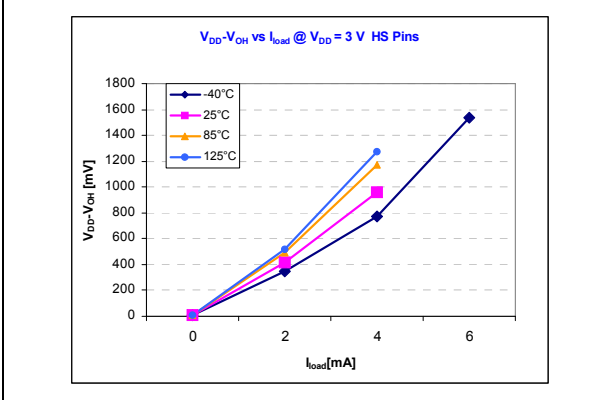

Figure 20. Typical  $V_{DD}-V_{OH}$  vs.  $V_{DD}$  at  $I_{load} = 4\text{ mA}$

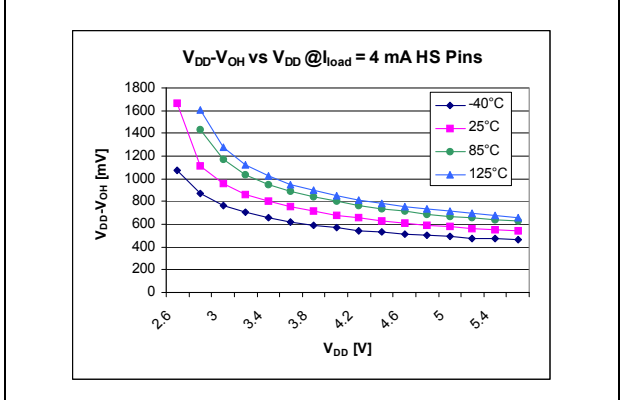
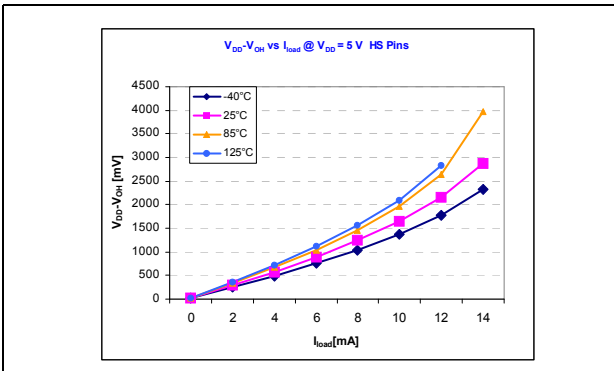

Figure 21. Typical  $V_{DD}-V_{OH}$  vs.  $I_{load}$  at  $V_{DD} = 5\text{ V}$



## 6.8 $\overline{\text{RESET}}$ pin

$T_A = -40^\circ\text{C}$  to  $125^\circ\text{C}$ , unless otherwise specified.

**Table 33.  $\overline{\text{RESET}}$  pin characteristics**

Symbol	Parameter	Conditions		Min.	Typ.	Max.	Unit
$V_{IL}$	Input low level voltage			$V_{SS} - 0.3$		$0.3 \times V_{DD}$	V
$V_{IH}$	Input high level voltage			$0.7 \times V_{DD}$		$V_{DD} + 0.3$	
$V_{hys}$	Schmitt trigger voltage hysteresis <sup>(1)</sup>				2		V
$V_{OL}$	Output low level voltage <sup>(2)</sup>	$V_{DD} = 5\text{V}$	$I_{IO} = +2\text{mA}$		200		mV
$R_{ON}$	Pull-up equivalent resistor <sup>(3)</sup>	$V_{IN} = V_{SS}$	$V_{DD} = 5\text{V}$	30	50	70	k $\Omega$
			$V_{DD} = 3\text{V}$		90 <sup>(1)</sup>		
$t_{w(\text{RSTL})\text{out}}$	Generated reset pulse duration	Internal reset sources			90 <sup>(1)</sup>		$\mu\text{s}$
$t_{h(\text{RSTL})\text{in}}$	External reset pulse hold time <sup>(4)</sup>			20			$\mu\text{s}$
$t_{g(\text{RSTL})\text{in}}$	Filtered glitch duration				200		ns

1. Data based on characterization results, not tested in production.
2. The  $I_{IO}$  current sunk must always respect the absolute maximum rating specified in [Table 22: Current characteristics on page 31](#) and the sum of  $I_{IO}$  (I/O ports and control pins) must not exceed  $I_{VSS}$ .
3. The  $R_{ON}$  pull-up equivalent resistor is based on a resistive transistor. Specified for voltages on  $\overline{\text{RESET}}$  pin between  $V_{IL\text{max}}$  and  $V_{DD}$ .
4. To guarantee the reset of the device, a minimum pulse has to be applied to the  $\overline{\text{RESET}}$  pin. All short pulses applied on  $\overline{\text{RESET}}$  pin with a duration below  $t_{h(\text{RSTL})\text{in}}$  can be ignored.

## 6.9 I<sup>2</sup>C control interface

Subject to general operating conditions for V<sub>DD</sub>, and T<sub>A</sub> unless otherwise specified.

The QST108 I<sup>2</sup>C interface meets the requirements of the Standard I<sup>2</sup>C communication protocol described in the following table with the restriction mentioned below:

Refer to I/O port characteristics for more details on the input/output alternate function characteristics (SDA and SCL).

**Table 34. I<sup>2</sup>C characteristics (100 kHz speed)**

Symbol	Parameter	Min. (1)	Max. (1)	Unit
t <sub>w(SCLL)</sub>	SCL clock low time	4.7		μs
t <sub>w(SCLH)</sub>	SCL clock high time	4.0		
t <sub>su(SDA)</sub>	SDA setup time	250		ns
t <sub>h(SDA)</sub>	SDA data hold time	0 (2)		
t <sub>r(SDA)</sub> t <sub>r(SCL)</sub>	SDA and SCL rise time		1000	ns
t <sub>f(SDA)</sub> t <sub>f(SCL)</sub>	SDA and SCL fall time		300	
t <sub>h(STA)</sub>	START condition hold time	4.0		μs
t <sub>su(STA)</sub>	Repeated START condition setup time	4.7		
t <sub>su(STO)</sub>	STOP condition setup time	4.0		μs
t <sub>w(STO:STA)</sub>	STOP to START condition time (bus free)	4.7		μs
C <sub>b</sub>	Capacitive load for each bus line		400	pF

1. Data based on standard I2C protocol requirement, not tested in production.
2. The maximum hold time of the START condition has only to be met if the interface does not stretch the low period of the SCL signal.

**Table 35.  $\overline{\text{IRQ}}$  specific pin characteristics (1)**

Symbol	Parameter	Conditions	Min.	Typ.	Max.	Unit
t <sub>w(IRQ)</sub>	$\overline{\text{IRQ}}$ pulse width		10		15	μs
R <sub>IRQ</sub>	$\overline{\text{IRQ}}$ internal pull-up (2)	V <sub>DD</sub> = 5V	100	120	140	kΩ
		V <sub>DD</sub> = 3V		300		

1. For additional pin parameters, please use the pin description in [Section 6.7: KOUTn/OPTn/GPON pin characteristics on page 36](#).
2. The  $\overline{\text{IRQ}}$  pull-up equivalent resistor is based on a resistive transistor.



Figure 22. Typical application with I<sup>2</sup>C bus and timing diagram

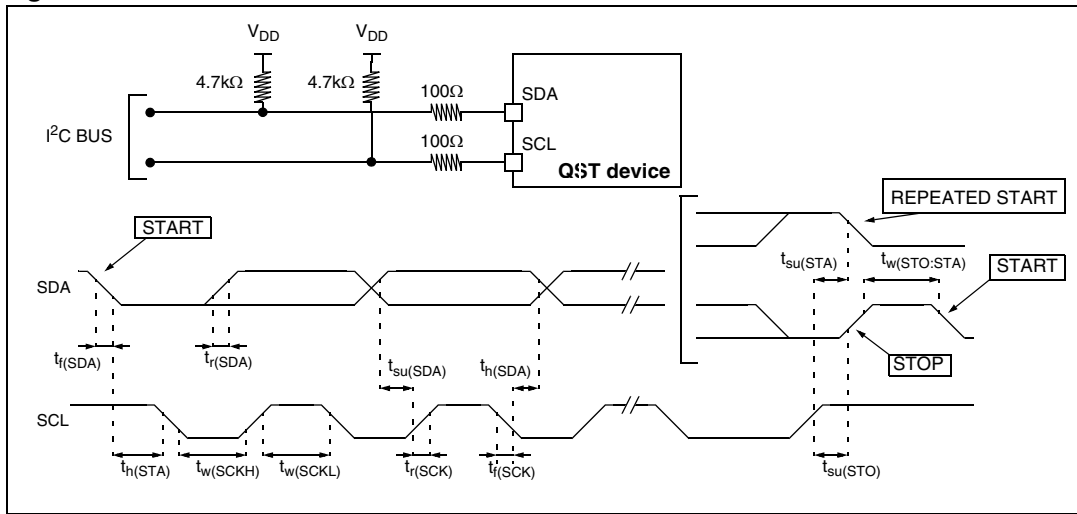

# 7 Package mechanical data

Figure 23. 32-pin low profile quad flat package (7x7) outline

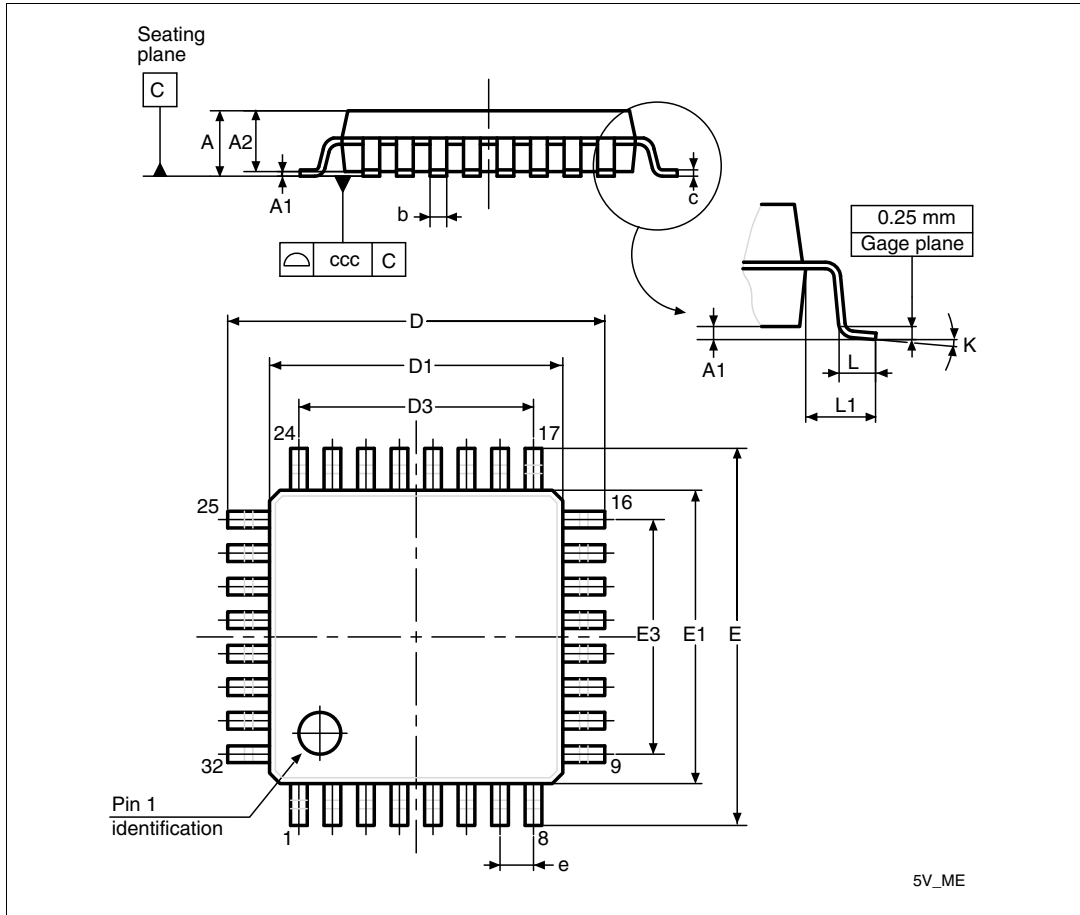
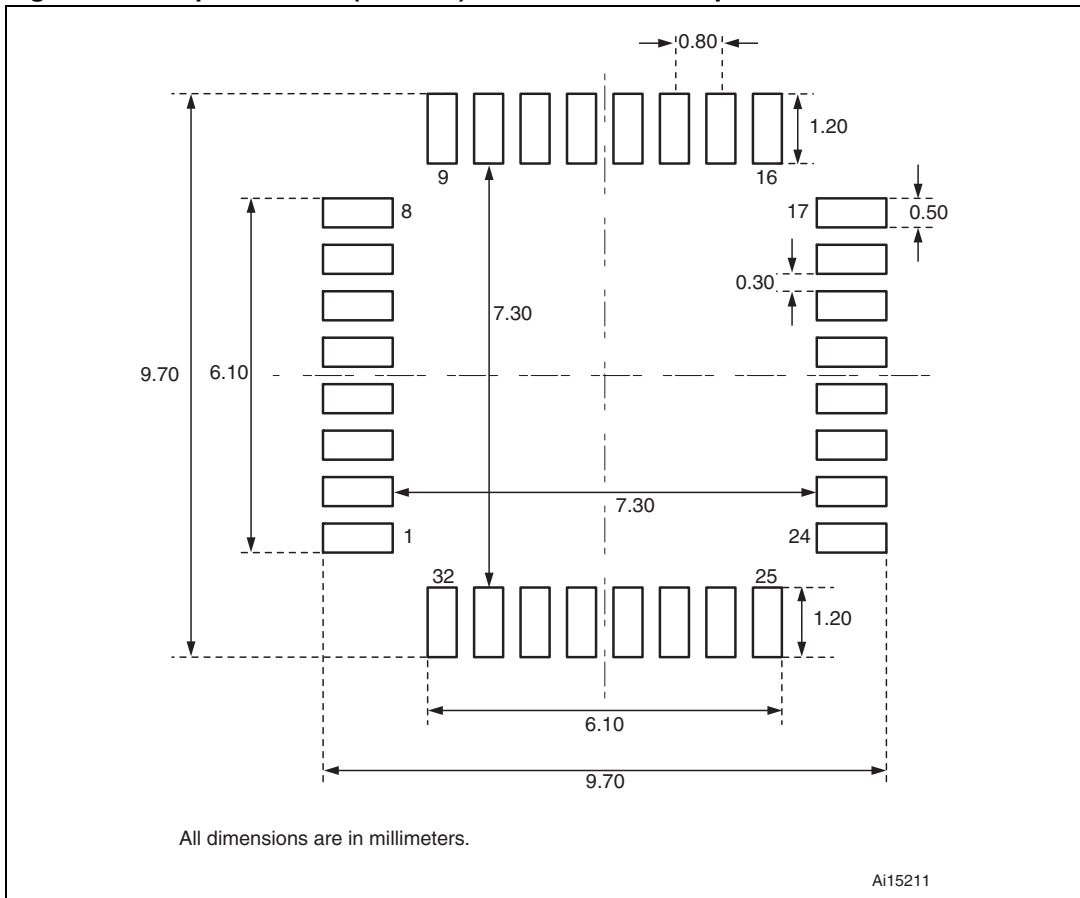

Table 36. 32-pin low profile quad flat package mechanical data

Dim.	mm			inches <sup>(1)</sup>		
	Min.	Typ.	Max.	Min.	Typ.	Max.
<b>A</b>			1.600			0.0630
<b>A1</b>	0.050		0.150	0.0020		0.0059
<b>A2</b>	1.350	1.400	1.450	0.0531	0.0551	0.0571
<b>b</b>	0.300	0.370	0.450	0.0118	0.0146	0.0177
<b>c</b>	0.090		0.200	0.0035		0.0079
<b>D</b>	8.800	9.000	9.200	0.3465	0.3543	0.3622
<b>D1</b>	6.800	7.000	7.200	0.2677	0.2756	0.2835
<b>D3</b>		5.600			0.2205	
<b>E</b>	8.800	9.000	9.200	0.3465	0.3543	0.3622
<b>E1</b>	6.800	7.000	7.200	0.2677	0.2756	0.2835
<b>E3</b>		5.600			0.2205	
<b>e</b>		0.800			0.0315	
<b>L</b>	0.450	0.600	0.750	0.0177	0.0236	0.0295
<b>L1</b>		1.000			0.0394	
<b>K</b>	0.0°	3.5°	7.0°	0.0°	3.5°	7.0°
	Tolerance (mm)			Tolerance (inches)		
<b>ccc</b>	0.10			0.0039		

1. Values in inches are converted from mm and rounded to 4 decimal digits.

Figure 24. 32-pin LQFP32 (7x7 mm) recommended footprint



## 7.1 Soldering information

In accordance with the RoHS European directive, all STMicroelectronics packages have been converted to lead-free technology, named ECOPACK™.

- ECOPACK™ packages are qualified according to the JEDEC STD-020C compliant soldering profile.
- Detailed information on the STMicroelectronics ECOPACK™ transition program is available on [www.st.com/stonline/leadfree/](http://www.st.com/stonline/leadfree/), with specific technical Application notes covering the main technical aspects related to lead-free conversion (AN2033, AN2034, AN2035, and AN2036).

### Backward and forward compatibility

The main difference between Pb and Pb-free soldering process is the temperature range.

- ECOPACK™ LQFP, SDIP, SO and DFN8 packages are fully compatible with Lead (Pb) containing soldering process (see application note AN2034).
- LQFP, SDIP and SO Pb-packages are compatible with Lead-free soldering process, nevertheless it's the customer's duty to verify that the Pb-packages maximum temperature (mentioned on the Inner box label) is compatible with their Lead-free soldering temperature.

**Table 37. Soldering Compatibility (wave and reflow soldering process)**

Package	Plating material devices	Pb solder paste	Pb-free solder paste <sup>(1)</sup>
SDIP & PDIP	Sn (pure Tin)	Yes	Yes
DFN8	Sn (pure Tin)	Yes	Yes
TQFP and SO	NiPdAu (Nickel-palladium-Gold)	Yes	Yes

1. Assemblers must verify that the Pb-package maximum temperature (mentioned on the Inner box label) is compatible with their Lead-free soldering process.

# 8 Part numbering

**Table 38. Ordering information scheme**

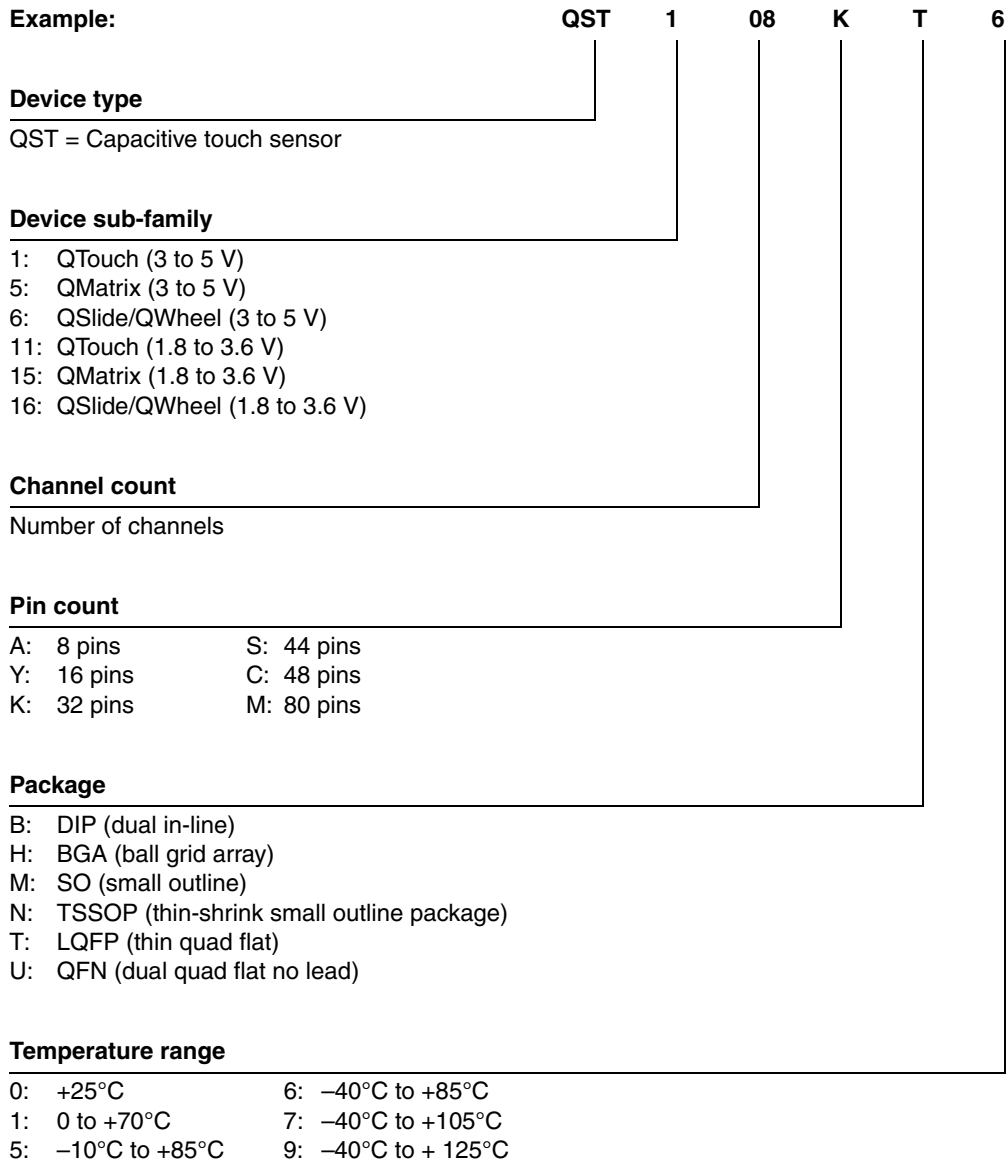

For a list of available options (speed, package, etc.) or for further information on any aspect of this device, please contact your nearest ST Sales Office.

The category of second Level Interconnect is marked on the package and on the inner box label, in compliance with JEDEC Standard JESD97. The maximum ratings related to soldering conditions are also marked on the inner box label.

## 9 Device revision information

### 9.1 Device revision identification

The marking on the right side of the second line (Line B) of the package top face identifies the device revision.

**Figure 25. Device revision identification (TQFP package)**

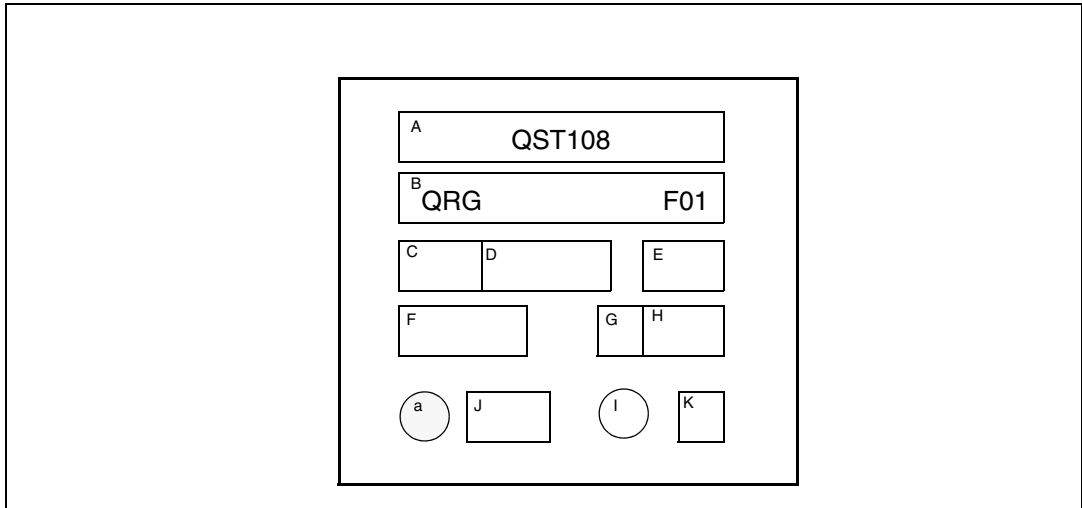

**Table 39. Device revision identification**

Marking	Device revision
F00	V 2.1
F01	V 2.3

The device revision can also be obtained using the GET\_DEVICE\_INFO I<sup>2</sup>C command. For more information, refer to [Section 4.9: Supported commands on page 16](#).

### 9.2 Device revision history

This section identifies the device deviations from the present specification for each device revision.

#### 9.2.1 Revision 2.1

Engineering samples. For more information regarding this revision, please contact your local ST sales office.

## 9.2.2 Revision 2.3

- When the device enters Low Power mode, an additional sleep time is inserted after each burst, instead of once after every complete burst cycle. As a result, if only one burst is required, the sleep duration during Low Power mode is doubled. And if two bursts are required, the sleep duration is tripled.  
In Standalone mode, the 100ms sleep duration low power becomes either a 200ms or 300ms sleep duration depending on the number of bursts required.  
In I2C mode, it is required to program a sleep duration for one half or a third of the desired sleep duration depending on the number of bursts required.
- GET\_PROTOCOL\_VERSION returns 0x01 as I2CSpeed byte when it should return 0x00 (maximum speed is 100 kHz).
- If a command is sent with an incorrect parity bit, the device reports an unsupported command instead of a parity error.
- In I2C mode, it is recommended to set the fast positive recalibration threshold to 5 using the SET\_SCKEY\_PARAMETERS command in order to ensure a reliable behavior on low sensitivity keys.
- AKS should be always enabled in BCD mode. The AKS pull-up option resistor should be connected to pin KOUT2.



## 10 Revision history

**Table 40. Document revision history**

Date	Revision	Changes
8-Jun-2007	1	Initial release.
15-Jun-2007	2	Datasheet status changed to Preliminary Data.
26-Sep-2007	3	<p>Removed Beeper function.</p> <p>Changed LED output pins to GPO pins.</p> <p>Updated pin names and functions in <a href="#">Section 2: Pin description on page 5</a> and added <a href="#">Figure 2: QTouch™ measuring circuitry on page 7</a>.</p> <p>Changed order of chapters in Section 3 for better comprehension.</p> <p>Removed Simplified independent output mode from <a href="#">Section 4: Device operating modes on page 11</a>. Independent output mode renamed Stand-alone mode.</p> <p>Added <a href="#">Section 4.2: Reset and power-up on page 11</a> and removed <a href="#">Power supply option</a> chapter from <a href="#">Section 4.4.2: Option descriptions on page 14</a>.</p> <p>Updated <a href="#">Table 6: Max On-Duration (MOD) truth table on page 14</a> and <a href="#">Table 7: Output mode (OM) truth table on page 15</a>.</p> <p>Updated <a href="#">Figure 3: Stand-alone mode typical schematic on page 13</a> and <a href="#">Figure 4: I2C mode typical schematic on page 16</a>.</p> <p>Updated <a href="#">Table 9: I<sup>2</sup>C address versus option resistor on page 18</a>.</p> <p>Added <a href="#">Figure 5: Optional LED schematic on page 17</a>.</p> <p>Updated <a href="#">Section 4.5: I2C mode on page 15</a>.</p> <p>Added <a href="#">Section 5.2.3: Key balance on page 25</a>.</p> <p>Updated <a href="#">Section 6.4: Supply current characteristics on page 31</a>.</p> <p>Added <a href="#">Section 6.5: Capacitive sensing characteristics on page 32</a> and <a href="#">Section 6.7: RESET pin on page 36</a>.</p> <p>Updated <a href="#">Table 30: I<sup>2</sup>C characteristics on page 37</a>.</p>
22-Nov-2007	4	<p>Document status promoted from Preliminary Data to Datasheet.</p> <p>Added ECOPACK® information.</p> <p>Updated C<sub>x</sub> value in <a href="#">Figure 2: QTouch™ measuring circuitry on page 7</a>.</p> <p>Added Caution note in <a href="#">Section 3.10: Drift compensation on page 11</a>.</p> <p>Added <a href="#">Section 4.3: Low power mode on page 13</a>.</p> <p>Updated hex values in <a href="#">Table 9: I<sup>2</sup>C address versus option resistor on page 21</a>.</p> <p>Updated <a href="#">Table 28: Supply current characteristics on page 34</a>, <a href="#">Table 30: Capacitive sensing parameters on page 35</a> and added <a href="#">Figure 10: IDD Sleep mode current characteristics on page 34</a>.</p> <p>Added <a href="#">Table 35: IRQ specific pin characteristics on page 40</a>.</p> <p>Added <a href="#">Section 9: Device revision information on page 47</a>.</p>

Table 40. Document revision history (continued)

Date	Revision	Changes
11-Jul-2008	5	<p>Changed datasheet status to Not for new design.</p> <p>Updated <a href="#">Figure 2: QTouch™ measuring circuitry</a> to add R<sub>S</sub> sense resistor.*</p> <p>Updated <a href="#">Section 3.5: Detection integrator filter on page 9</a> and added <a href="#">Figure 3: Detection signals on page 10</a>.</p> <p>Added <a href="#">Figure 4: Drift compensation example on page 12</a>.</p> <p>GET_KEY_ERROR and GET_KEY_STATE read values updated in <a href="#">Table 10: Supported commands on page 21</a> and updated note 3.</p> <p>Updated bit values for <a href="#">Key activation description on page 25</a>.</p> <p>Added <a href="#">Section 6.3: EMC characteristics on page 32</a>.</p> <p>Updated <a href="#">Table 30: Capacitive sensing parameters on page 35</a>.</p> <p>Added <a href="#">Figure 24: 32-pin LQFP32 (7x7 mm) recommended footprint on page 44</a>.</p> <p>Added <a href="#">Section 7.1: Soldering information on page 45</a>.</p> <p>Added <a href="#">Section 9.2.2: Revision 2.3 on page 48</a>.</p>

**Please Read Carefully:**

Information in this document is provided solely in connection with ST products. STMicroelectronics NV and its subsidiaries ("ST") reserve the right to make changes, corrections, modifications or improvements, to this document, and the products and services described herein at any time, without notice.

All ST products are sold pursuant to ST's terms and conditions of sale.

Purchasers are solely responsible for the choice, selection and use of the ST products and services described herein, and ST assumes no liability whatsoever relating to the choice, selection or use of the ST products and services described herein.

No license, express or implied, by estoppel or otherwise, to any intellectual property rights is granted under this document. If any part of this document refers to any third party products or services it shall not be deemed a license grant by ST for the use of such third party products or services, or any intellectual property contained therein or considered as a warranty covering the use in any manner whatsoever of such third party products or services or any intellectual property contained therein.

**UNLESS OTHERWISE SET FORTH IN ST'S TERMS AND CONDITIONS OF SALE ST DISCLAIMS ANY EXPRESS OR IMPLIED WARRANTY WITH RESPECT TO THE USE AND/OR SALE OF ST PRODUCTS INCLUDING WITHOUT LIMITATION IMPLIED WARRANTIES OF MERCHANTABILITY, FITNESS FOR A PARTICULAR PURPOSE (AND THEIR EQUIVALENTS UNDER THE LAWS OF ANY JURISDICTION), OR INFRINGEMENT OF ANY PATENT, COPYRIGHT OR OTHER INTELLECTUAL PROPERTY RIGHT.**

**UNLESS EXPRESSLY APPROVED IN WRITING BY AN AUTHORIZED ST REPRESENTATIVE, ST PRODUCTS ARE NOT RECOMMENDED, AUTHORIZED OR WARRANTED FOR USE IN MILITARY, AIR CRAFT, SPACE, LIFE SAVING, OR LIFE SUSTAINING APPLICATIONS, NOR IN PRODUCTS OR SYSTEMS WHERE FAILURE OR MALFUNCTION MAY RESULT IN PERSONAL INJURY, DEATH, OR SEVERE PROPERTY OR ENVIRONMENTAL DAMAGE. ST PRODUCTS WHICH ARE NOT SPECIFIED AS "AUTOMOTIVE GRADE" MAY ONLY BE USED IN AUTOMOTIVE APPLICATIONS AT USER'S OWN RISK.**

Resale of ST products with provisions different from the statements and/or technical features set forth in this document shall immediately void any warranty granted by ST for the ST product or service described herein and shall not create or extend in any manner whatsoever, any liability of ST.

ST and the ST logo are trademarks or registered trademarks of ST in various countries.

Information in this document supersedes and replaces all information previously supplied.

The ST logo is a registered trademark of STMicroelectronics. All other names are the property of their respective owners.

© 2008 STMicroelectronics - All rights reserved

STMicroelectronics group of companies

Australia - Belgium - Brazil - Canada - China - Czech Republic - Finland - France - Germany - Hong Kong - India - Israel - Italy - Japan - Malaysia - Malta - Morocco - Singapore - Spain - Sweden - Switzerland - United Kingdom - United States of America

[www.st.com](http://www.st.com)

