

PE94302

**50Ω RF Digital Step Attenuator
Radiation Tolerant for Space
Applications, 6-bit, 31.5 dB, 4.0 GHz**

Product Description

Peregrine's PE94302 is a high linearity, 6-bit UltraCMOS® RF digital step attenuator (DSA). This 50Ω RF DSA covers a 31.5 dB attenuation range in 0.5 dB steps. It provides both parallel and serial CMOS control interface. The PE94302 maintains high attenuation accuracy over frequency and temperature and exhibits very low insertion loss and power consumption.

The PE94302 is optimized for commercial space applications. Single event latch-up (SEL) is physically impossible and single event upset (SEU) is better than 10/9 errors per bit/day. Fabricated in Peregrine's UltraCMOS technology, a patented variation of silicon-on-insulator (SOI) technology on a sapphire substrate, the PE94302 offers excellent RF performance and intrinsic radiation tolerance.

Features

- Attenuation: 0.5 dB steps to 31.5 dB
- Flexible parallel and serial programming interfaces
- 100 kRad (Si) total dose
- Positive CMOS control logic
- High attenuation accuracy and linearity over temperature and frequency
- Low power: 100 μA @ 3.0V
- 50Ω impedance

Figure 1. Functional Diagram

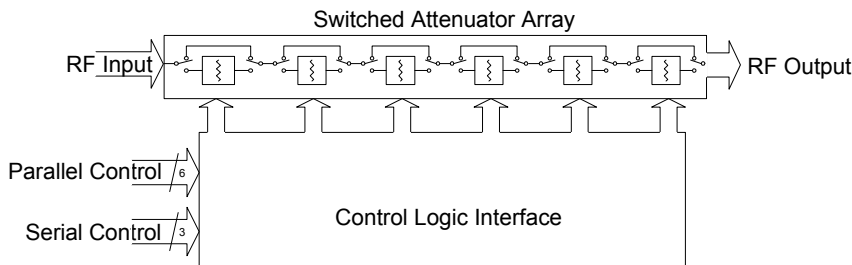

**Figure 2. Package Type
28-lead CQFP**

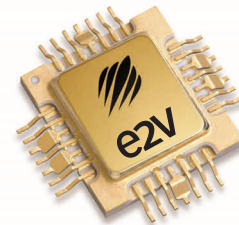

Table 1. Electrical Specifications @ -40 °C ≤ Temp ≤ +85 °C, 2.7V ≤ V_{DD} ≤ 3.30V

| Parameter | Test Conditions | Frequency | Min | Typ | Max | Unit |
|----------------------|------------------------|------------------|---------------------------------|-----|---------------------------------|------|
| Operation frequency | | 250 kHz–4000 MHz | | | | MHz |
| Insertion loss | | 250 kHz–2.2 GHz | | 1.5 | 2.75 | dB |
| Attenuation accuracy | 0.5–8.0 dB atten | 250 kHz–1.0 GHz | -(0.55 + 3.7% of atten setting) | | +(0.55 + 3.7% of atten setting) | dB |
| | 8.5–31.5 dB atten | | | | + 0.9 | |
| | 0.5–4.0 dB atten | 1.0–2.2 GHz | | | +(0.70 + 3.0% of atten setting) | |
| | 4.5–31.5 dB atten | | | | + 0.9 | |
| | 0.5–23.0 dB atten | | | | -(0.7 + 3.0% of atten setting) | |
| | 23.5–31.5 dB atten | | -(0.6 + 9.0% of atten setting) | | | |
| 1dB compression | | 1 MHz–2.2 GHz | | 33 | | dBm |
| Input IP3 | Two-tone inputs | | | 52 | | dBm |
| Return loss | | 250 kHz–2.2 GHz | | 15 | | dB |
| Switching speed | Min to max atten state | | | | 1 | μs |

Notes: 1. Device linearity will begin to degrade below 1 MHz.
2. Electrical specifications guaranteed at maximum input power = +12 dBm.
3. Specs are guaranteed to 2.2 GHz, characterized to 4.0 GHz.

Figure 3. Pin Configuration (Top View)

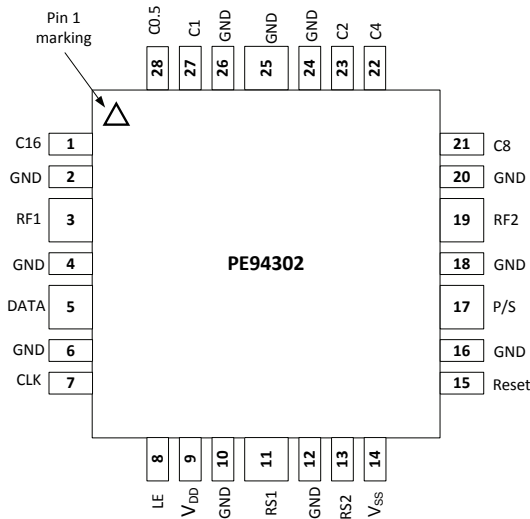

Table 2. Pin Descriptions

| Pin # | Pin Name | Description |
|-------|-----------------|---|
| 1 | C16 | Attenuation control bit, 16 dB. |
| 2 | GND | Ground. |
| 3 | RF1 | RF port (Note 1). |
| 4 | GND | Ground. |
| 5 | DATA | Serial interface data input. |
| 6 | GND | Ground. |
| 7 | CLK | Serial interface clock input. |
| 8 | LE | Latch enable input (Note 2). |
| 9 | V _{DD} | Power supply pin. |
| 10 | GND | Ground. |
| 11 | RS1 | Redundant signal (Note 3). |
| 12 | GND | Ground. |
| 13 | RS2 | Redundant signal (Note 3). |
| 14 | V _{SS} | Negative supply voltage (Note 4). |
| 15 | Reset | Reset (Note 5). |
| 16 | GND | Ground. |
| 17 | P/S | Parallel/serial mode select. |
| 18 | GND | Ground. |
| 19 | RF2 | RF port (Note 1). |
| 20 | GND | Ground. |
| 21 | C8 | Attenuation control bit, 8 dB. |
| 22 | C4 | Attenuation control bit, 4 dB. |
| 23 | C2 | Attenuation control bit, 2 dB. |
| 24 | GND | Ground. |
| 25 | GND | Ground. |
| 26 | GND | Ground. |
| 27 | C1 | Attenuation control bit, 1 dB. |
| 28 | C0.5 | Attenuation control bit, 0.5 dB. |
| Pad | GND | Exposed pad: Ground for proper operation. |

- Notes:
- Both RF ports must be held at 0 VDC or DC blocked with an external series capacitor.
 - Latch enable (LE) has an internal 100 kΩ resistor to V_{DD}.
 - Must be tied to V_{DD} or GND under normal operation.
 - Must be tied to external supply with V_{SS} = -V_{DD}.
 - Must be tied to GND under normal operation.

Table 3. Absolute Maximum Ratings

| Symbol | Parameter/Conditions | Min | Max | Unit |
|------------------|---|------|-----------------------|----------------|
| V _{DD} | Power supply voltage | -0.3 | 4.0 | V |
| V _{SS} | Negative power supply voltage (-V _{DD}) | -4.0 | 0.3 | V |
| V _I | Voltage on any DC input | -0.3 | V _{DD} + 0.3 | V |
| T _{ST} | Storage temperature range | -65 | +150 | °C |
| Θ _{JC} | Theta JC | | 13 | °C/W |
| T _J | Junction temperature maximum | | +125 | °C |
| P _{IN} | Input power (50Ω) 5 MHz-<100 MHz 100 MHz | | 22 24 | dBm dBm |
| V _{ESD} | ESD voltage (human body model) | | 500 | V |

Exceeding absolute maximum ratings may cause permanent damage. Operation should be restricted to the limits in the Operating Ranges table. Operation between operating range maximum and absolute maximum for extended periods may reduce reliability.

Table 4. Operating Ranges

| Parameter | Min | Typ | Max | Unit |
|---|-----------------------|------|-----------------------|------|
| V _{DD} power supply voltage | 2.7 | 3.0 | 3.3 | V |
| V _{SS} power supply voltage | -3.3 | -3.0 | -2.7 | V |
| I _{DD} power supply current | | | 250 | μA |
| I _{SS} power supply current | -500 | | | μA |
| RF input power (50Ω) ≥ 5 MHz | | | 17 | dBm |
| T _{OP} operating temperature range | -40 | | +85 | °C |
| Digital input high | 0.7 × V _{DD} | | | V |
| Digital input low | | | 0.3 × V _{DD} | V |
| Digital input leakage | | | 1 | μA |

Electrostatic Discharge (ESD) Precautions

When handling this UltraCMOS device, observe the same precautions that you would use with other ESD-sensitive devices. Although this device contains circuitry to protect it from damage due to ESD, precautions should be taken to avoid exceeding the rating specified.

Latch-Up Immunity

Unlike conventional CMOS devices, UltraCMOS devices are immune to latch-up.

ELDRS

The UltraCMOS process does not exhibit enhanced low-dose-rate sensitivity (ELDRS) since bipolar minority carrier elements are not used.

Programming Options

Parallel/Serial Selection

Either a Parallel or Serial interface can be used to control the PE94302. The P/S bit provides this selection, with P/S = LOW selecting the Parallel interface and P/S = HIGH selecting the Serial interface.

Parallel Mode Interface

The Parallel interface consists of six CMOS-compatible control lines that select the desired attenuation state, as shown in *Table 5*.

The Parallel interface timing requirements are defined by *Figure 5* (Parallel Interface Timing Diagram), *Table 8* (Parallel Interface AC Characteristics) and switching speed (*Table 1*).

For Latched Parallel programming the latch enable (LE) should be held LOW while changing attenuation state control values, then pulse LE HIGH to LOW (per *Figure 5*) to latch new attenuation state into device.

For Direct Parallel programming, the LE should be either pulled high or floated (see *Table 2, Note 2*). Changing attenuation state control values will change device state to new attenuation. Direct mode is ideal for manual control of the device (using hardware, switches or jumpers).

Serial Interface

The Serial interface is a 6-bit serial-in, parallel-out shift register buffered by a transparent latch. It is controlled by three CMOS-compatible signals: DATA, CLK and LE. The DATA and CLK inputs allow data to be serially entered into the shift register, a process that is independent of the state of the LE input.

The LE input controls the latch. When LE is HIGH, the latch is transparent and the contents of the serial shift register control the attenuator. When LE is brought LOW, data in the shift register is latched.

The shift register should be loaded while LE is held LOW to prevent the attenuator value from changing as data is entered. The LE input should then be toggled HIGH and brought LOW again, latching the new data. The timing for this operation is defined by *Figure 4* (Serial Interface Timing Diagram) and *Table 7* (Serial Interface AC Characteristics).

Table 5. Truth Table*

| P/S | C16 | C8 | C4 | C2 | C1 | C0.5 | Attenuation State |
|-----|-----|----|----|----|----|------|-------------------|
| 0 | 0 | 0 | 0 | 0 | 0 | 0 | Reference loss |
| 0 | 0 | 0 | 0 | 0 | 0 | 1 | 0.5 dB |
| 0 | 0 | 0 | 0 | 0 | 1 | 0 | 1 dB |
| 0 | 0 | 0 | 0 | 1 | 0 | 0 | 2 dB |
| 0 | 0 | 0 | 1 | 0 | 0 | 0 | 4 dB |
| 0 | 0 | 1 | 0 | 0 | 0 | 0 | 8 dB |
| 0 | 1 | 0 | 0 | 0 | 0 | 0 | 16 dB |
| 0 | 1 | 1 | 1 | 1 | 1 | 1 | 31.5 dB |

Note: * Not all 64 possible combinations of C0.5–C16 are shown in table.

Typical Performance Data @ +25 °C, $V_{DD} = -V_{SS} = 3.0V$, unless otherwise specified

Figure 6. Input Return Loss vs Frequency

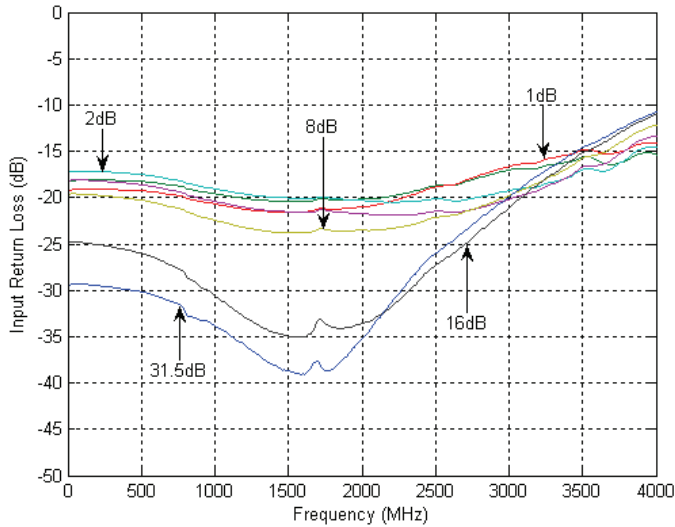

Figure 7. Output Return Loss vs Frequency

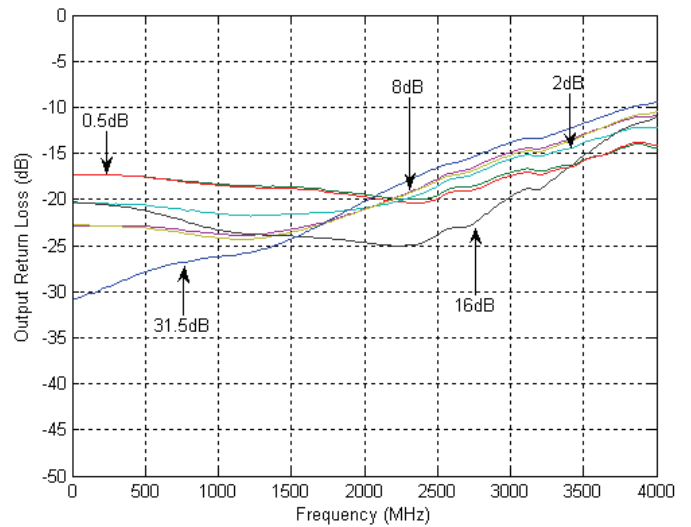

Figure 8. Insertion Loss vs Frequency

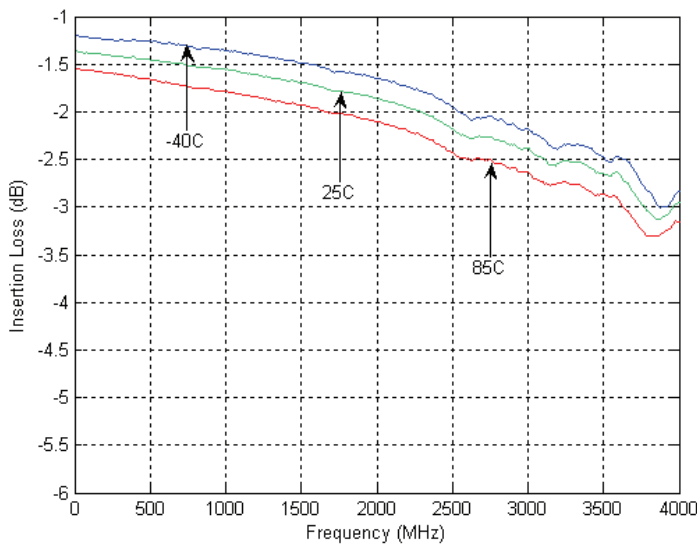
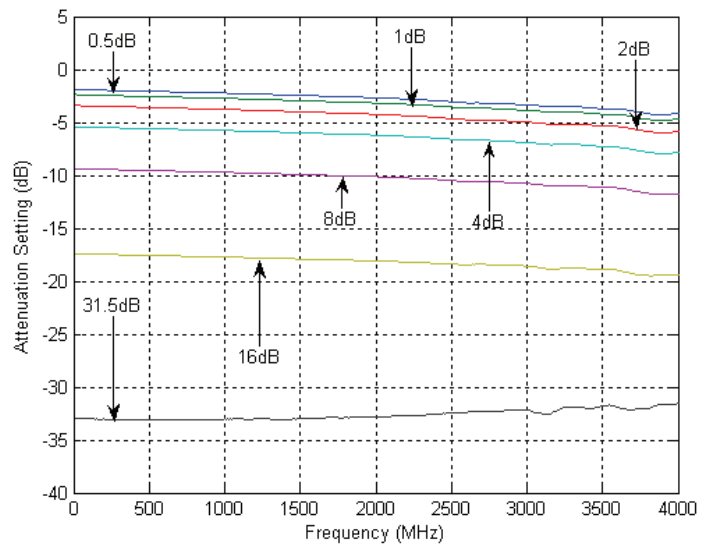

Figure 9. Attenuation Setting vs Frequency



Typical Performance Data @ +25 °C, $V_{DD} = -V_{SS} = 3.0V$, unless otherwise specified (cont.)

Figure 10. Attenuation Error vs Frequency

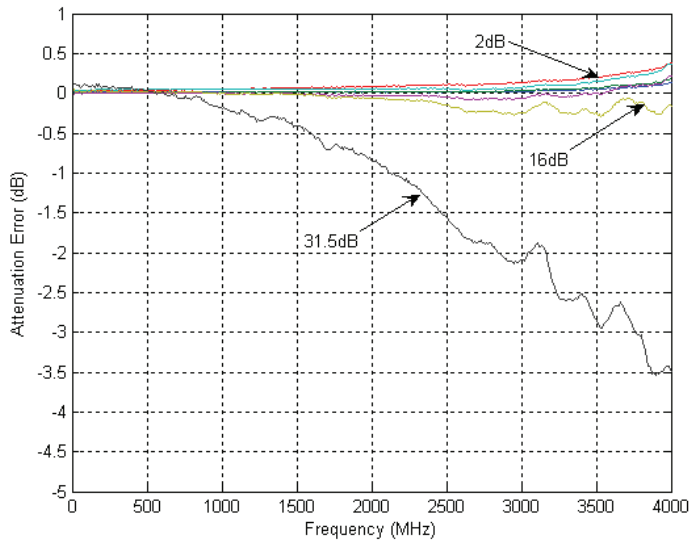

Figure 11. Attenuation Error vs Setting

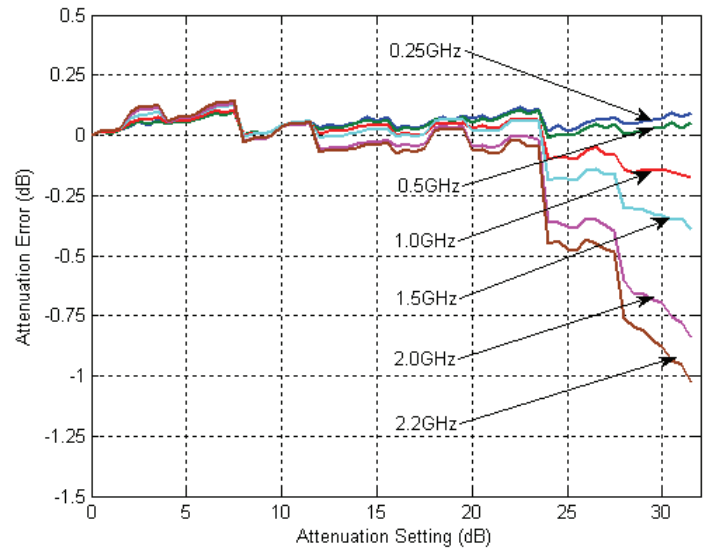

Figure 12. IIP3 vs Frequency

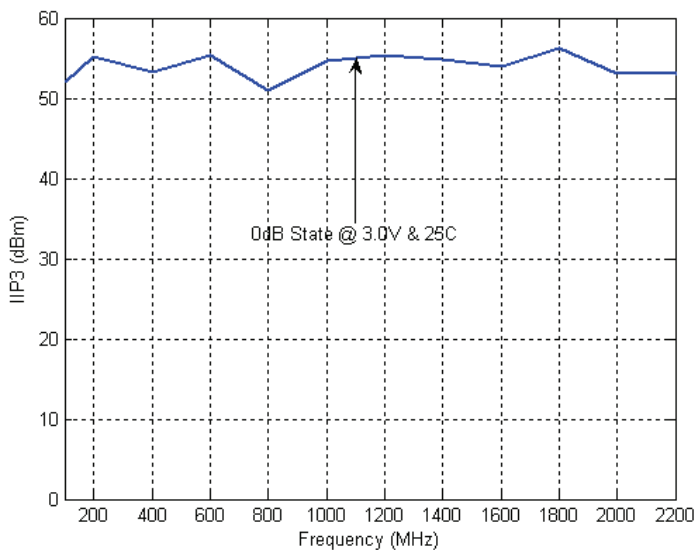

Figure 13. 1dB Compression vs Frequency

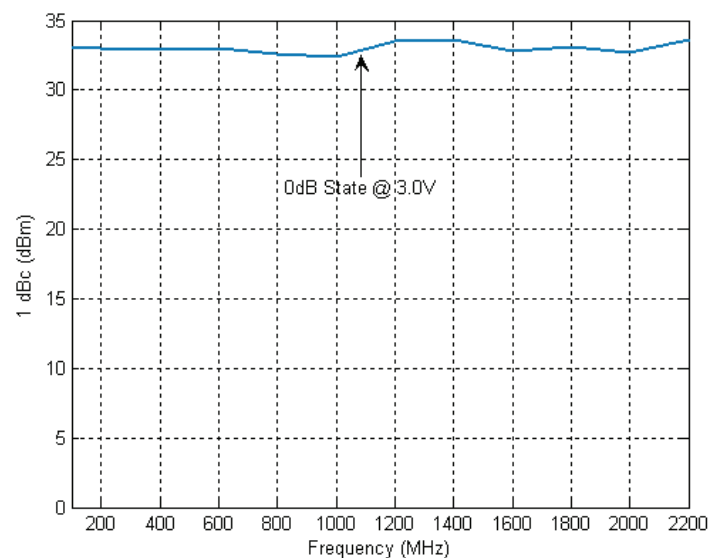
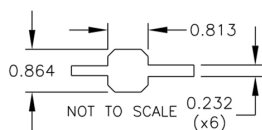
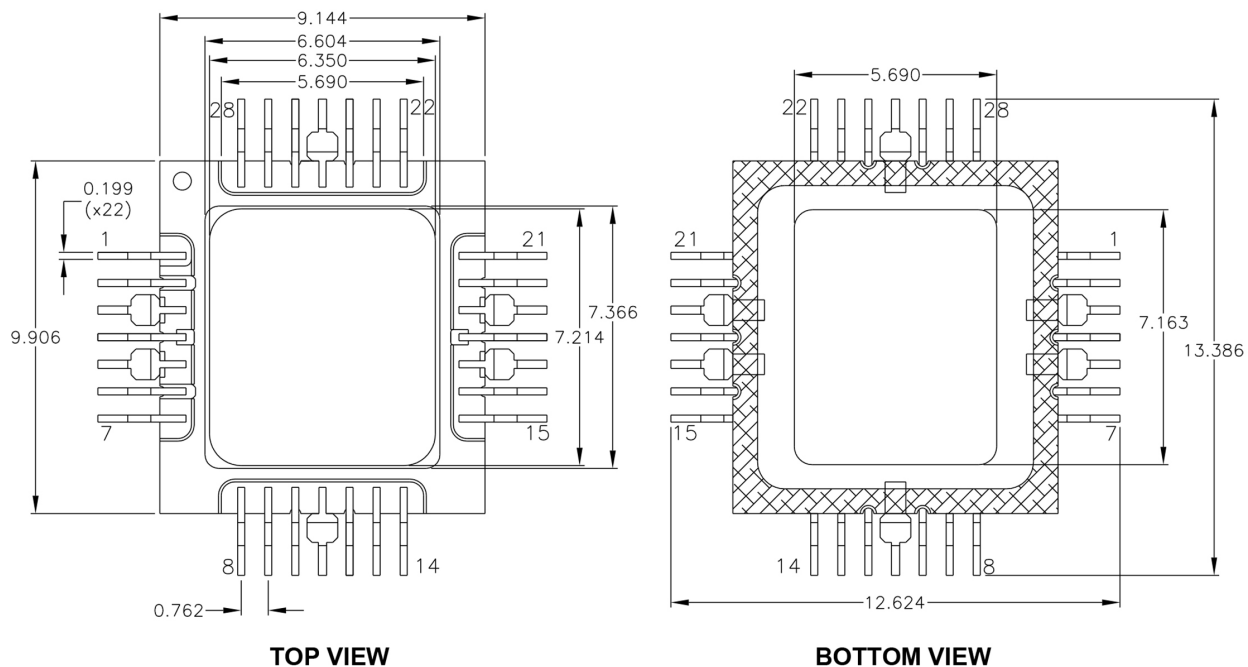
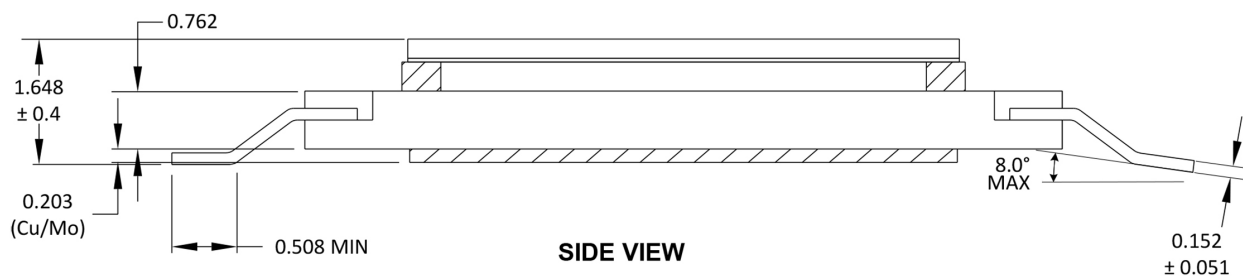

Figure 14. Package Drawing (dimensions in millimeters)
28-lead CQFP



DETAIL OF LEADS # 3, 5, 11, 17, 19 & 25



LEAD TIPS 0.10 MM COPLANARITY
AND PLANAR WITH
BOTTOM OF HEATSPREADER
WITHIN 0.20 MM

DIMS IN MM.
ALL TOLERANCES ARE +/- 0.127
UNLESS OTHERWISE STATED.
NOT TO SCALE

Rev. 98 060717
IIGNALB

Figure 14. Package Drawing (dimensions in millimeters) (cont.)

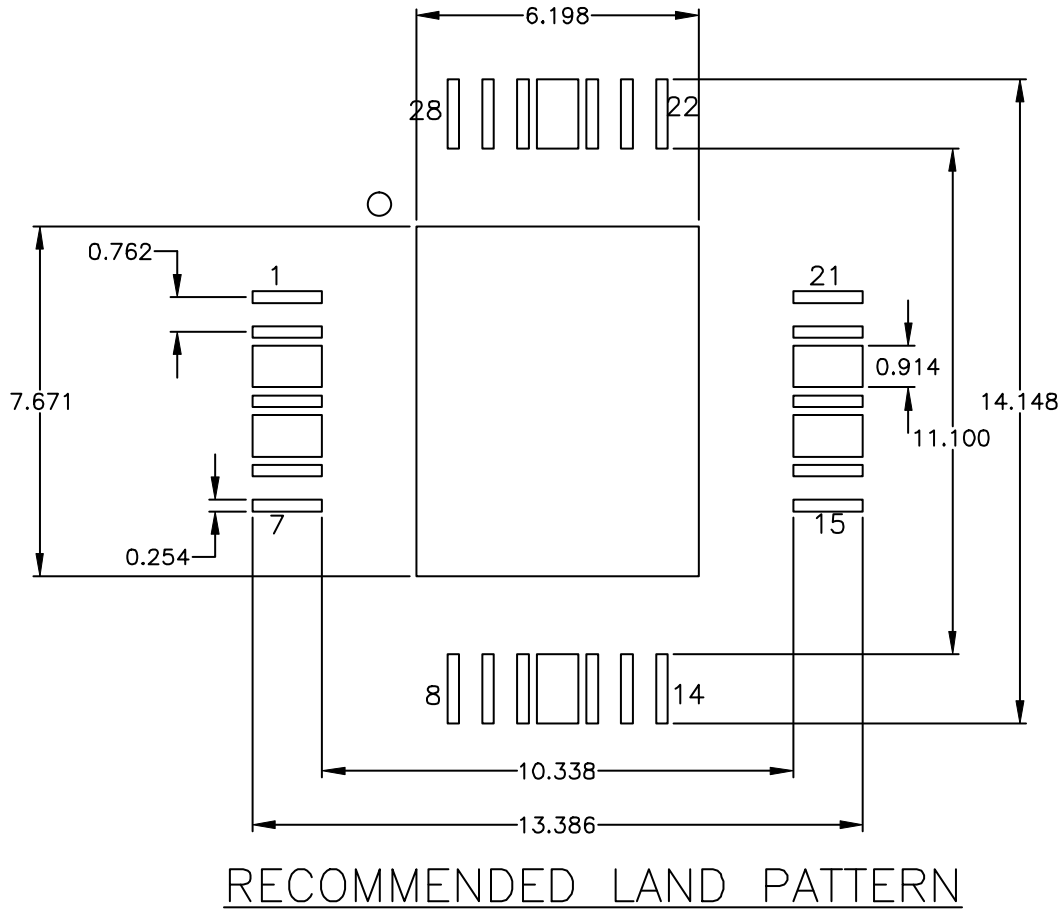
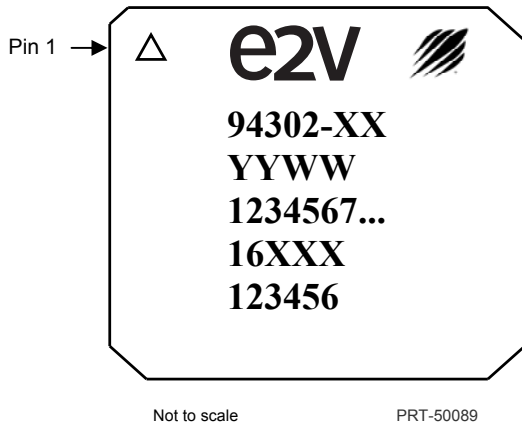

Figure 15. Top Marking Specifications



- Line 1: Pin 1 indicator \triangle , e2v and Peregrine logo
- Line 2: Part number (XX will be specified by the purchase order)
- Line 3: Date code (last two digits of the year and work week)
- Line 4: Wafer lot # (as many characters as room allows)
- Line 5: DOP # (e2v internal / 5 digits / optional, as room allows)
- Line 6: Serial # (5 digits minimum)

Note: There is **NO** backside marking on any of the Peregrine products.

Table 9. Ordering Information

| Order Code | Description | Package | Shipping Method |
|------------|---------------------|------------------|-----------------------|
| 94302-01* | Engineering samples | 28-lead CQFP | 24 units / JEDEC tray |
| 94302-11 | Production units | 28-lead CQFP | 24 units / JEDEC tray |
| 94302-00 | Evaluation kit | Evaluation board | 1 / box |

Note: *The PE94302-01 devices are engineering sample (ES) prototype units intended for use as initial evaluation units for customers of the PE94302-11 flight units. The PE94302-01 device provides the same functionality and footprint as the PE94302-11 space qualified device, and intended for engineering evaluation only. They are tested at +25 °C only and processed to a non-compliant flow (e.g. no burn-in, non-hermetic, etc). These units are non-hermetic and are not suitable for qualification, production, radiation testing or flight use.

Sales Contact and Information

Contact Information:
e2v ~ <http://www.teledyne-e2v.com> ~ inquiries@e2v-us.com

Advance Information: The product is in a formative or design stage. The datasheet contains design target specifications for product development. Specifications and features may change in any manner without notice.
Preliminary Specification: The datasheet contains preliminary data. Additional data may be added at a later date. Peregrine reserves the right to change specifications at any time without notice in order to supply the best possible product.
Product Specification: The datasheet contains final data. In the event Peregrine decides to change the specifications, Peregrine will notify customers of the intended changes by issuing a CNF (Customer Notification Form).

The information in this datasheet is believed to be reliable. However, Peregrine assumes no liability for the use of this information. Use shall be entirely at the user's own risk.
No patent rights or licenses to any circuits described in this datasheet are implied or granted to any third party. Peregrine's products are not designed or intended for use in devices or systems intended for surgical implant, or in other applications intended to support or sustain life, or in any application in which the failure of the Peregrine product could create a situation in which personal injury or death might occur. Peregrine assumes no liability for damages, including consequential or incidental damages, arising out of the use of its products in such applications.
The Peregrine name, logo, UltraCMOS and UTSi are registered trademarks and HaRP, MultiSwitch and DuNE are trademarks of Peregrine Semiconductor Corp. Peregrine products are protected under one or more of the following U.S. Patents: <http://patents.psemi.com>.