

REV.	DESCRIPTION	DRAWN	CHECKED	APPROVED
A	NEW RELEASE	YCH 08/13/07'	~	

www.DataSheet4U.com

NOTES:

- PRODUCTS PERFORMANCE:
  - VOLTAGE RATING: 250V AC.
  - CONTACT CURRENT RATING: 1.5A MAX. PER PIN.
  - CONTACT RESISTANCE: 20mΩ MAX.
  - DIELECTRIC WITHSTANDING VOLTAGE: 500V AC(rms) FOR 1 MINUTE.
  - INSULATION RESISTANCE: 1000MΩ MINI.
  - OPERATING TEMPERATURE: -20°C~+70°C.
- PRODUCT NUMBER CODE:

DS1037-02 - X X X X X X X X

- SCREW DIM. E
  - 4: 4.80mm
  - 5: 5.80mm
- BOARD LOCK DIM. F
  - 4: 4.00mm
  - 7: 3.70mm
- CONTACT PLATING
  - T: SELECTIVE GOLD FLASH
  - Si: FULL GOLD FLASH
  - 6: FULL TIN
- COLOR OF HOUSING
  - K: BLACK
  - B: BLUE
- SCREW TYPE
  - A: WITH SCREW TYPE
  - C: WITH SCREW AND RIVET TYPE
- SHELL PLATING
  - N: Nickel
  - T: Tin
- CONNECTOR TYPE
  - M: MALE
  - F: FEMALE
- No. OF CONTACT
  - 09: 9pos.
  - 15: 15pos.
  - 25: 25pos.
  - 37: 37pos.

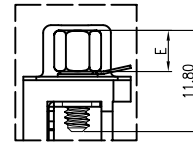
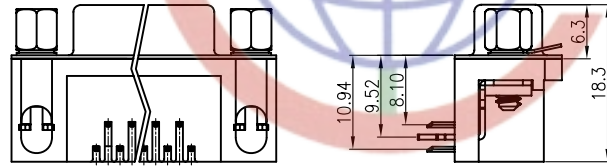
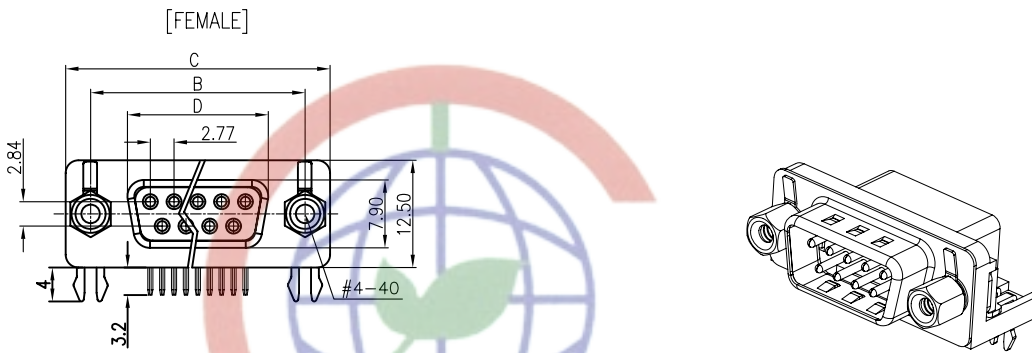

WITH SCREW TYPE

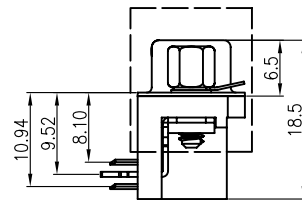
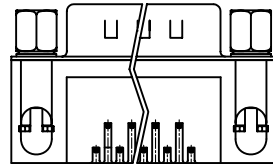
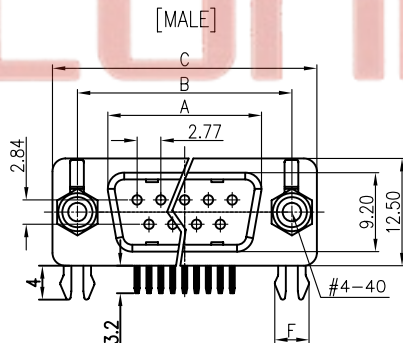

WITH SCREW AND RIVET TYPE

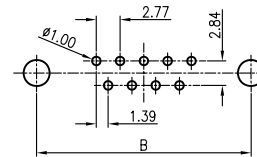

RECOMMEND PCB LAYOUT(TOLERANCE ±0.05)  
(VIEW FROM TOP SIDE)

Dimension

Position	A±0.2	B±0.2	C±0.2	D
9	17.90	24.99	30.84	16.33
15	26.50	33.32	39.14	24.66
25	40.00	47.04	53.04	38.38
37	56.50	63.50	69.32	54.84

www.DataSheet4U.com

GENERAL TOLERANCE		ANGLE TOLERANCE	
X.	±0.60	X.	±5°
.X	±0.38	.X	±3°
.XX	±0.25	.XX	±2°
DRAWING TYPE		CUSTOMER	
SCALE		1:1	SHEET 1 OF 1
DRAWING NO.		C-DS1037-02-XXXXXXX	

PROJECTION	TITLE
	D-SUB RIGHT ANGLE(7.2mm)WITH SHIELDING TYPE
UNITS	mm
SHEET SIZE	A4
SERIES	DS1037-02 SERIES

**晨翔电子有限公司**  
**CONNFLY CONNFLY ELECTRONIC CO. LTD**