

# DIODE MODULE

# DD130F

UL:E76102(M)

Power Diode Module **DD130F** series are designed for various rectifier circuits. **DD130F** has two diode chips connected in series in a package and the mounting base is electrically isolated from elements for simple heatsink construction. Wide voltage rating up to, 1,600V is available for various input voltage.

- Isolated mounting base
- Two elements in a package for simple (single and three phase) bridge connections
- Highly reliable glass passivated chips
- High surge current capability

**(Applications)**

Various rectifiers, Battery chargers, DC motor drives

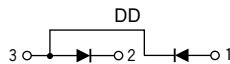
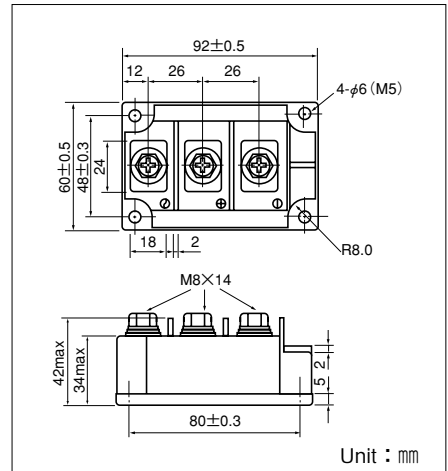

**Maximum Ratings**

(T<sub>j</sub>=25°C unless otherwise specified)

Symbol	Item	Ratings				Unit
		DD130F40	DD130F80	DD130F120	DD130F160	
V <sub>RRM</sub>	Repetitive Peak Reverse Voltage	400	800	1200	1600	V
V <sub>RSM</sub>	Non-Repetitive Peak Reverse Voltage	480	960	1300	1700	V

Symbol	Item	Conditions	Ratings	Unit	
I <sub>F(AV)</sub>	Average Forward Current	Single phase, half wave, 180° conduction, T <sub>c</sub> : 90°C	130	A	
I <sub>F(RMS)</sub>	R.M.S. Forward Current	Single phase, half wave, 180° conduction, T <sub>c</sub> : 90°C	205	A	
I <sub>FSM</sub>	Surge Forward Current	1/2 cycle, 50/60Hz, peak value, non-repetitive	4000/4400	A	
I <sup>2</sup> t	I <sup>2</sup> t	Value for one cycle of surge current	80000	A <sup>2</sup> S	
V <sub>ISO</sub>	Isolation Breakdown Voltage (R.M.S)	A.C.1minute	2500	°C	
T <sub>j</sub>	Junction Temperature		-40 to +125	°C	
T <sub>stg</sub>	Storage Temperature		-40 to +125	V	
	Mounting Torque	Mounting (M5)	Recommended Value 1.5-2.5 (15-25)	2.7 (28)	N·m (kgf·cm)
		Terminal (M8)	Recommended Value 8.8-10 (90-105)	11 (115)	
	Mass			510	g

**Electrical Characteristics**

Symbol	Item	Conditions	Ratings	Unit
I <sub>RRM</sub>	Repetitive Peak Reverse Current, max.	at V <sub>DRM</sub> , single phase, half wave. T <sub>j</sub> =125°C	50	mA
V <sub>FM</sub>	Forward Voltage Drop, max.	Forward current 400A, T <sub>j</sub> =25°C, Inst. measurement	1.40	V
R <sub>th(j-c)</sub>	Thermal Impedance, max.	Junction to case	0.20	°C/W

**Maximum Forward Characteristics**

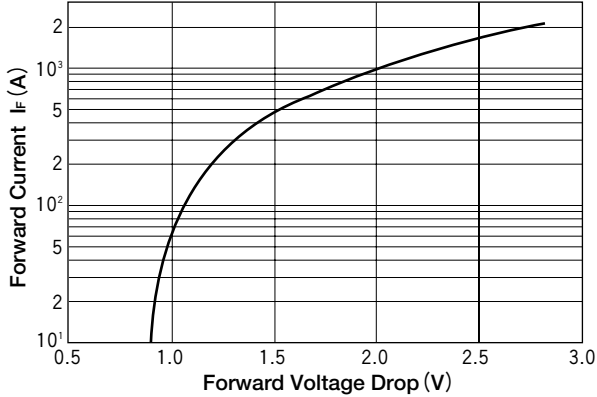

**Average Forward Current vs. Power Dissipation**

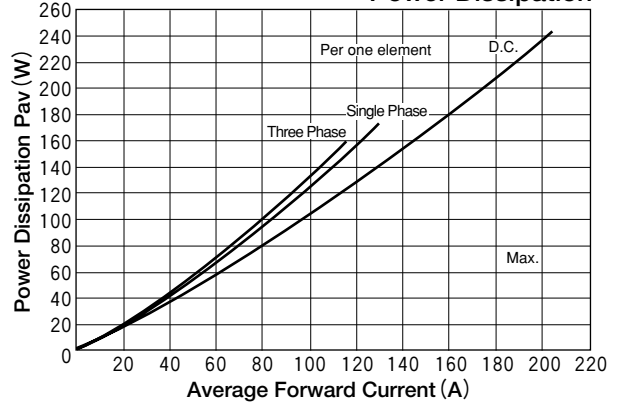

**Average Forward Current vs. Allowable Case Temperature**

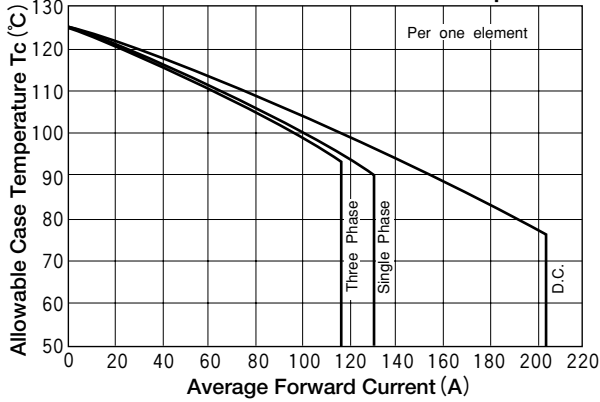

**Cycle Surge Forward Current Rating (Non-Repetitive)**

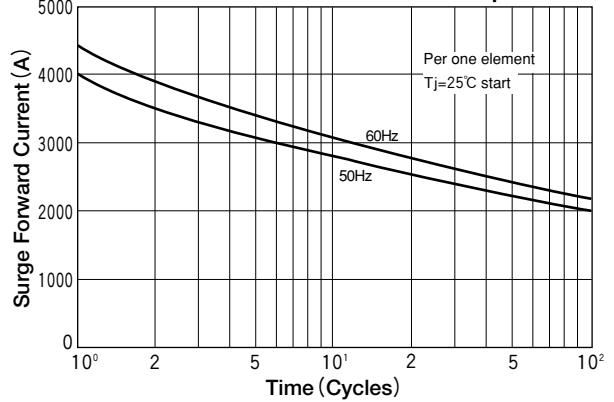

**Transient Thermal Impedance**

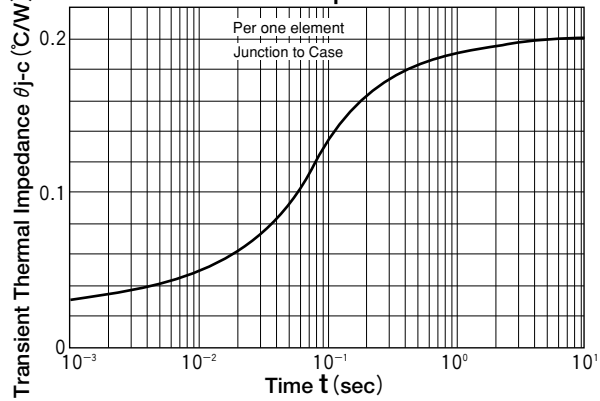

**B2; Two Pulse Bridge connection**

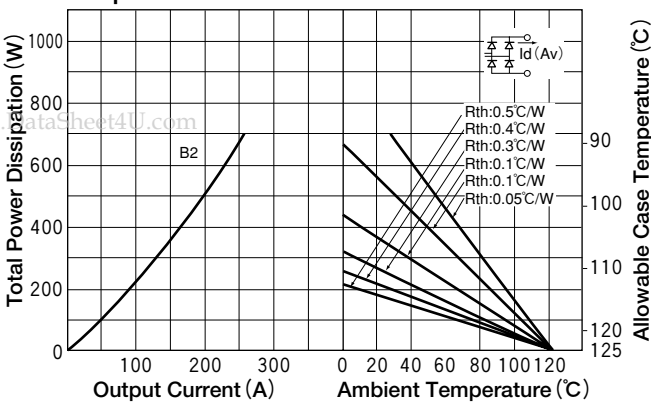

**B6; Six pulse Bridge connection**

