



3DD5310HF

主要参数 MAIN CHARACTERISTICS

BV_{CBO}	1000V
I_C	10 A
$V_{CE(sat)}$	0.5 V(max)
t_f	0.3 μ s(max)

用途

- 彩色电视机开关电源电路

APPLICATIONS

- Switching power supply for color TV.

产品特性

- 3DD5310HF 是 NPN 双极型高反压大功率晶体管，制造中采用的主要工艺技术有：高压平面工艺技术、三重扩散技术等，采用塑料全包封结构。环保（RoHS）产品。

FEATURES

- 3DD5310HF is high breakdown voltage of NPN bipolar transistor. The main process of manufacture: high voltage planar technology, triple diffused process etc., adoption of fully plastic package. RoHS product.

封装 Package

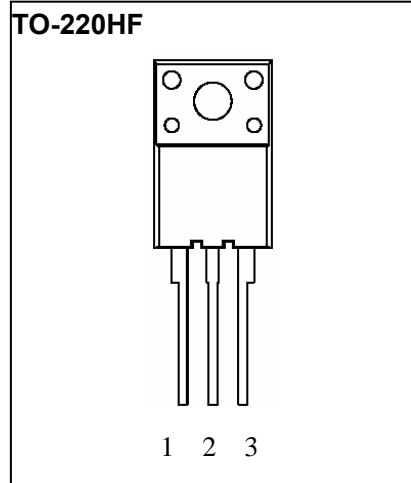

等效电路 EQUIVALENT CIRCUIT

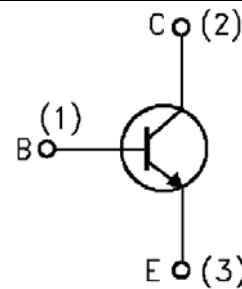

订货信息 ORDER MESSAGE

订货型号 Order codes	印记 Marking	无卤素 Halogen Free	封装 Package	包装 Packaging	器件重量 Device Weight
3DD5010HF-O-A-N-D	D5310HF	含卤素	TO-220HF	条管 Tube	--

印记说明 MARKING

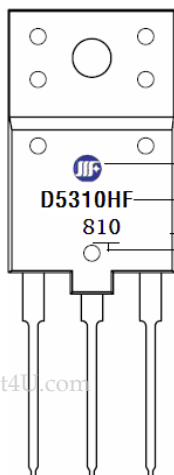

商标 Trademark

型号 Part No.

年月 Year month

举例 For example

“8” — 2008, “10” 10月 October





绝对最大额定值 ABSOLUTE RATINGS (Tc=25°C)

项 目 Parameter	符 号 Symbol	数 值 Value	单 位 Unit
集电极—基极直流电压 Collector-Base Voltage	BV_{CBO}	1000	V
集电极—发射极直流电压 Collector-Emitter Voltage	BV_{CEO}	600	V
发射极—基极直流电压 Emitter-Base Voltage	BV_{EBO}	6	V
最大集电极电流 Collector Current	直流 DC	I_C	10
	脉冲 Pulse	I_{CP}	20
最大基极直流电流 Base Current	I_B	5	A
最大集电极耗散功率 Collector Power Dissipation	P_C	35	W
最高结温 Max. Junction Temperature	T_j	150	°C
储存温度 Storage Temperature Range	T_{STG}	-55~+150	°C

电特性 ELECTRICAL CHARACTERISTICS (Tc=25°C)

项 目 Parameter	测试条件 Tests conditions	最小值 Min	最大值 Max	单 位 Unit
$V(BR)_{CEO}$	$I_C=10mA, I_B=0$	600		V
$V(BR)_{CBO}$	$I_C=1mA, I_E=0$	1000		V
$V(BR)_{EBO}$	$I_E=1mA, I_C=0$	6		V
I_{CBO}	$V_{CB}=900V, I_E=0$		1	mA
I_{EBO}	$V_{EB}=6V, I_C=0$		10	μA
H_{FE}	$V_{CE} = 5V, I_C = 1A$	20	35	
	$V_{CE} = 5V, I_C = 5A$	6		
$V_{CE(sat)}$	$I_C=3A, I_B=0.6A$		0.5	V
$V_{BE(sat)}$	$I_C=3A, I_B=0.6A$		1.3	V
t_f	$I_C=5A, 2I_{B1}=-I_{B2}=2A$		0.3	μs
t_s	$f_H=15.75kHz$		4	μs
f_t	$V_{CE}=10V, I_C=0.1A$	1.7		MHz





特征曲线 ELECTRICAL CHARACTERISTICS CURVES

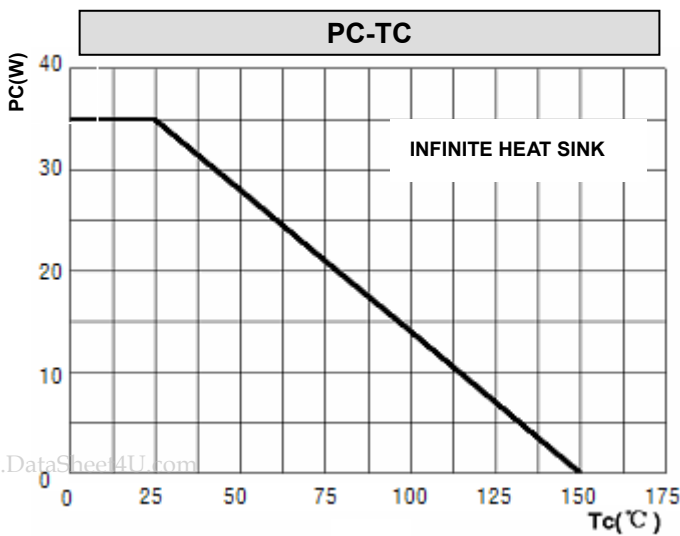
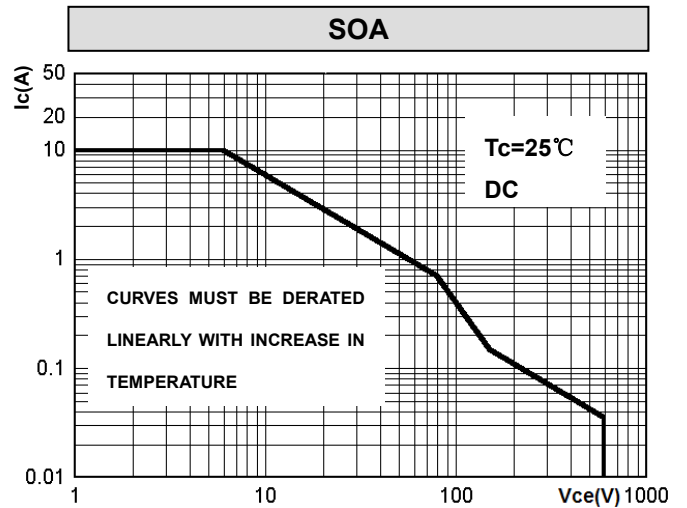
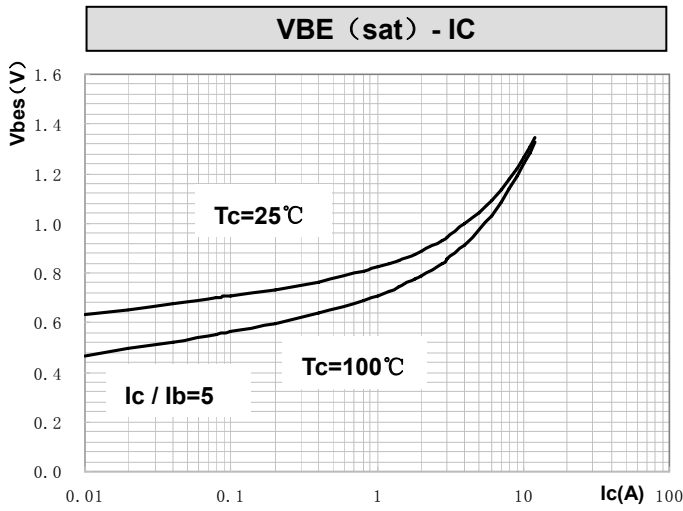
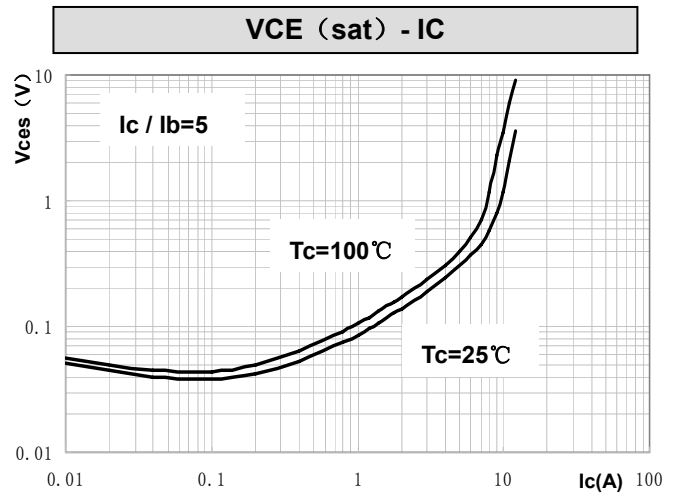
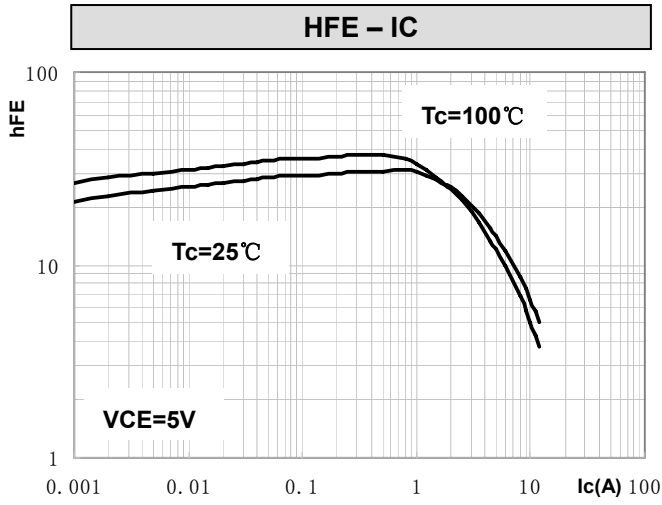

www.DataSheet4U.com





外形尺寸 PACKAGE MECHANICAL DATA
TO-220HF

单位 Unit :mm

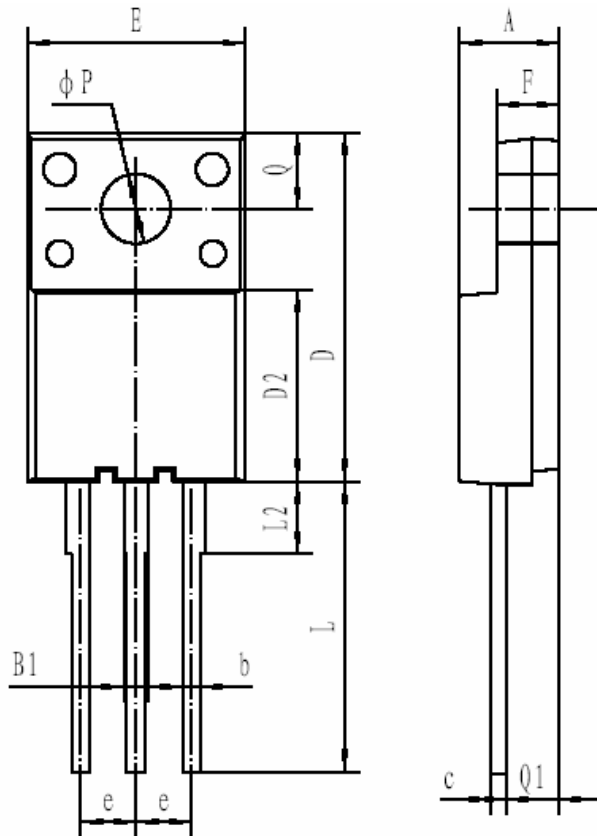

符号 Symbol	Min	Max
A	4.0	5.0
B1	0.87	1.27
b	0.72	0.92
c	0.5	0.70
D	15.0	16.5
D2	7.8	9.4
E	9.62	10.62
e	2.54(typ)	
F	2.3	3.3
L	12.0	14.0
L2	3.1	3.5
ϕP	3.0	3.4
Q	3.15	3.55
Q1	2.2	2.5

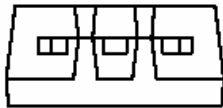

**注意事项**

- 1.吉林华微电子股份有限公司的产品销售分为直销和销售代理，无论哪种方式，订货时请与公司核实。
- 2.购买时请认清公司商标，如有疑问请与公司本部联系。
- 3.在电路设计时请不要超过器件的绝对最大额定值，否则会影响整机的可靠性。
- 4.本说明书如有版本变更不另外告知

NOTE

1. Jilin Sino-microelectronics co., Ltd sales its product either through direct sales or sales agent , thus, for customers, when ordering , please check with our company.
2. We strongly recommend customers check carefully on the trademark when buying our product, if there is any question, please don't be hesitate to contact us.
3. Please do not exceed the absolute maximum ratings of the device when circuit designing.
4. Jilin Sino-microelectronics co., Ltd reserves the right to make changes in this specification sheet and is subject to change without prior notice.

联系方式**吉林华微电子股份有限公司**

公司地址：吉林省吉林市深圳街 99 号

邮编：132013

总机：86-432-64678411

传真：86-432-64665812

网址：www.hwdz.com.cn**市场营销部**

地址：吉林省吉林市深圳街 99 号

邮编：132013

电话：86-432-64675588

64675688

64678411-3098/3099

传真：86-432-64671533

CONTACT**JILIN SINO-MICROELECTRONICS CO., LTD.**

ADD: No.99 Shenzhen Street, Jilin City, Jilin Province, China.

Post Code: 132013

Tel: 86-432-64678411

Fax: 86-432-64665812

Web Site: www.hwdz.com.cn**MARKET DEPARTMENT**

ADD: No.99 Shenzhen Street, Jilin City, Jilin Province, China.

Post Code: 132013

Tel: 86-432-64675588

64675688

64678411-3098/3099

Fax: 86-432-64671533

附录（Appendix）：修订记录（Revision History）

日期 Date	旧版本 Last Rev.	新版本 New Rev.	修订内容 Description of Changes
2010-12-23		012A	

