

Description

The SST3585 provide the designer with best combination of fast switching, low on-resistance and cost effectiveness.

The SOT-26 package is universally used for all commercial-industrial surface mount applications.

Features

- * RoHS Compliant
- * Low Gate Charge
- * Low On-resistance

SOT-26

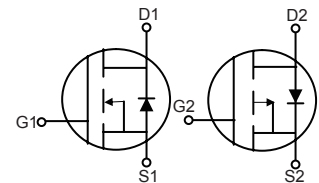
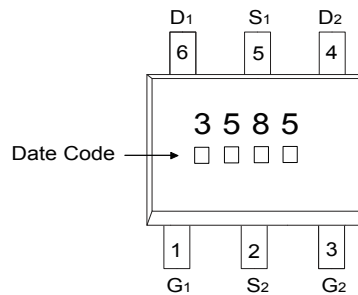
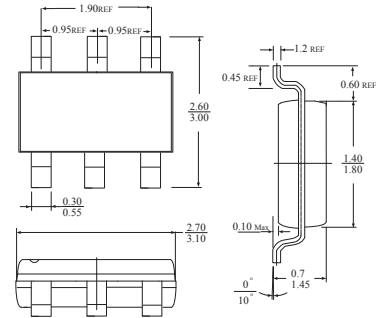

Absolute Maximum Ratings

Parameter	Symbol	Ratings		Unit
Drain-Source Voltage	V_{DS}	20	-20	V
Gate-Source Voltage	V_{GS}	±12	±12	V
Continuous Drain Current ³	$I_D @ T_A=25^\circ C$	3.5	-2.5	A
Continuous Drain Current ³	$I_D @ T_A=70^\circ C$	2.8	-1.97	A
Pulsed Drain Current ¹	I_{DM}	10	-10	A
Total Power Dissipation	$P_D @ T_A=25$	1.14		W
Linear Derating Factor		0.01		W/°C
Operating Junction and Storage Temperature Range	T_j, T_{stg}	-55~+150		°C

Thermal Data

Parameter	Symbol	Ratings	Unit
Thermal Resistance Junction-ambient ³	Rthj-a	110	°C/W

N-Channel Electrical Characteristics(Tj=25 °C Unless otherwise specified)

Parameter	Symbol	Min.	Typ.	Max.	Unit	Test Condition
Drain-Source Breakdown Voltage	BV _{DSS}	20	-	-	V	V _{GS} =0V, I _D =250uA
Breakdown Voltage Temp. Coefficient	ΔBV _{DS} /ΔT _j	-	0.02	-	V/°C	Reference to 25°C, I _D =-1mA
Gate Threshold Voltage	V _{GS(th)}	0.5	-	1.2	V	V _{DS} =V _{GS} , I _D =250uA
Gate-Source Leakage Current	I _{GSS}	-	-	±100	nA	V _{GS} =±12V
Drain-Source Leakage Current (Tj=25°C)	I _{DSS}	-	-	1	uA	V _{DS} =20V, V _{GS} =0
Drain-Source Leakage Current (Tj=70°C)		-	-	10	uA	V _{DS} =16V, V _{GS} =0
Static Drain-Source On-Resistance ²	R _{DS(ON)}	-	-	75	mΩ	V _{GS} =4.5V, I _D =3.5A
		-	-	125		V _{GS} =2.5V, I _D =1.2A
Total Gate Charge ²	Q _g	-	4	7	nC	I _D =3A V _{DS} =16V V _{GS} =4.5V
Gate-Source Charge	Q _{gs}	-	0.7	-		
Gate-Drain ("Miller") Charge	Q _{gd}	-	2	-		
Turn-on Delay Time ²	T _{d(ON)}	-	6	-	nS	V _{DS} =15V I _D =1A V _{GS} =5V R _G =3.3Ω R _D =15Ω
Rise Time	T _r	-	8	-		
Turn-off Delay Time	T _{d(OFF)}	-	10	-		
Fall Time	T _f	-	3	-		
Input Capacitance	C _{iss}	-	230	370	pF	V _{GS} =0V V _{DS} =20V f=1.0MHz
Output Capacitance	C _{oss}	-	55	-		
Reverse Transfer Capacitance	C _{rss}	-	40	-		
Forward Transconductance	G _{fs}	-	7	-	S	V _{DS} =5V, I _D =3A
Gate Resistance	R _g	-	1.1	1.7	Ω	f=1.0MHz

Source-Drain Diode

Parameter	Symbol	Min.	Typ.	Max.	Unit	Test Condition
Forward On Voltage ²	V _{DS}	-	-	1.2	V	I _S =1.2A, V _{GS} =0V.
Reverse Recovery Time	T _{rr}	-	16	-	nS	I _S =3A, V _{GS} =0V di/dt=100A/us
Reverse Recovery Charge	Q _{rr}	-	8	-	nC	

Notes: 1.Pulse width limited by Max. junction temperature.

2.Pulse width ≤300us, dutycycle ≤2%.

3.Surface mounted on 1 in² copper pad of FR4 board; 1 ≤5sec; 180°C/W when mounted on Min. copper pad.

P-Channel Electrical Characteristics(Tj=25 °C Unless otherwise specified)

Parameter	Symbol	Min.	Typ.	Max.	Unit	Test Condition
Drain-Source Breakdown Voltage	BV _{DSS}	-20	-	-	V	V _{GS} =0V, I _D =-250uA
Breakdown Voltage Temp. Coefficient	ΔBV _{DSS} /ΔT _j	-	-0.01	-	V/°C	Reference to 25°C, I _D =-1mA
Gate Threshold Voltage	V _{GS(th)}	-	-	-1.2	V	V _{DS} =V _{GS} , I _D =-250uA
Gate-Source Leakage Current	I _{GSS}	-	-	±100	nA	V _{GS} =±12V
Drain-Source Leakage Current (Tj=25°C)	I _{DSS}	-	-	-1	uA	V _{DS} =-20V, V _{GS} =0
Drain-Source Leakage Current (Tj=70°C)		-	-	-25	uA	V _{DS} =-16V, V _{GS} =0
Static Drain-Source On-Resistance ²	R _{DS(ON)}	-	-	120	mΩ	V _{GS} =-10V, I _D =-2.8A
		-	-	160		V _{GS} =-4.5V, I _D =-2.5A
		-	-	300		V _{GS} =-2.5V, I _D =-2A
Total Gate Charge ²	Q _g	-	5	8	nC	I _D =-2A V _{DS} =-16V V _{GS} =-4.5V
Gate-Source Charge	Q _{gs}	-	1	-		
Gate-Drain ("Miller") Charge	Q _{gd}	-	2	-		
Turn-on Delay Time ²	T _{d(ON)}	-	6	-	nS	V _{DS} =-10V I _D =-1A V _{GS} =-10V R _G =3.3Ω R _D =10Ω
Rise Time	T _r	-	17	-		
Turn-off Delay Time	T _{d(OFF)}	-	16	-		
Fall Time	T _f	-	5	-		
Input Capacitance	C _{iss}	-	270	430	pF	V _{GS} =0V V _{DS} =-20V f=1.0MHz
Output Capacitance	C _{oss}	-	70	-		
Reverse Transfer Capacitance	C _{rss}	-	55	-		
Forward Transconductance	G _{fs}	-	4	-		

Source-Drain Diode

Parameter	Symbol	Min.	Typ.	Max.	Unit	Test Condition
Forward On Voltage ²	V _{DS}	-	-	-1.2	V	I _S =-1.2A, V _{GS} =0V.
Reverse Recovery Time ²	T _{rr}	-	20	-	nS	I _S =-2A, V _{GS} =0V dI/dt=100A/uS
Reverse Recovery Charge	Q _{rr}	-	15	-	nC	

Notes: 1.Pulse width limited by Max. junction temperature.

2.Pulse width ≤300us, dutycycle ≤2%.

3.Surface mounted on 1 in² copper pad of FR4 board; 1 ≤5sec; 180°C/W when mounted on Min. copper pad.

Characteristics Curve N-Channel

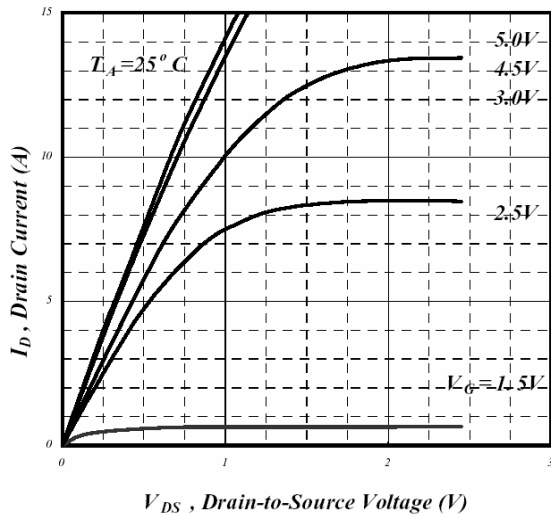

Fig 1. Typical Output Characteristics

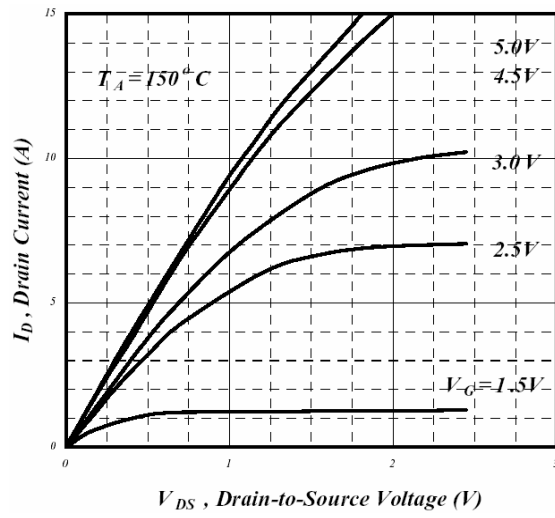

Fig 2. Typical Output Characteristics

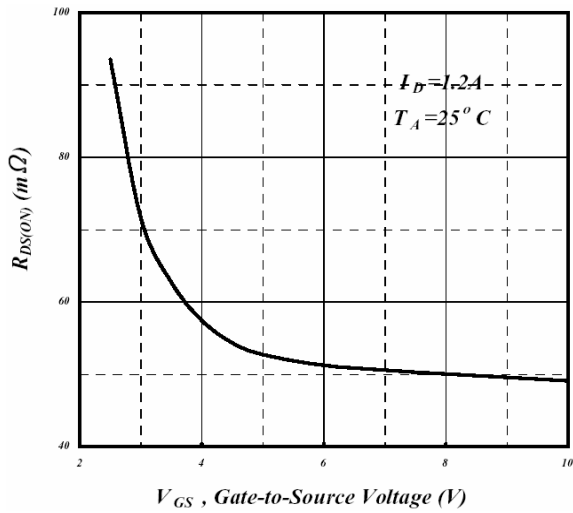

Fig 3. On-Resistance v.s. Gate Voltage

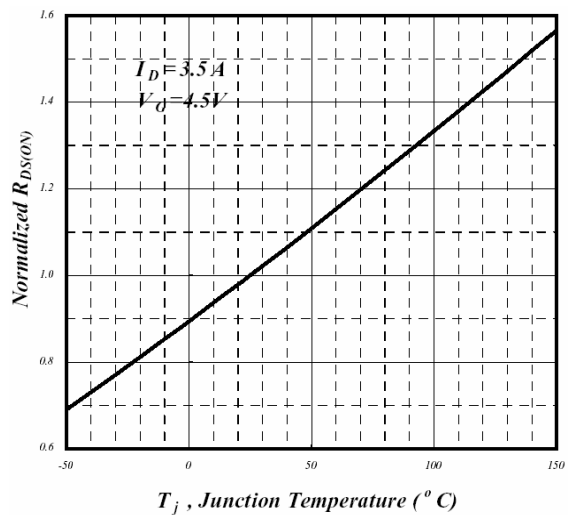

Fig 4. Normalized On-Resistance v.s. Junction Temperature

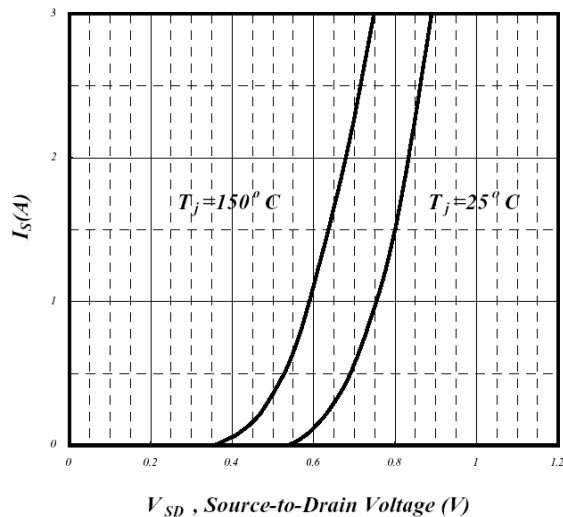

Fig 5. Forward Characteristics of Reverse Diode

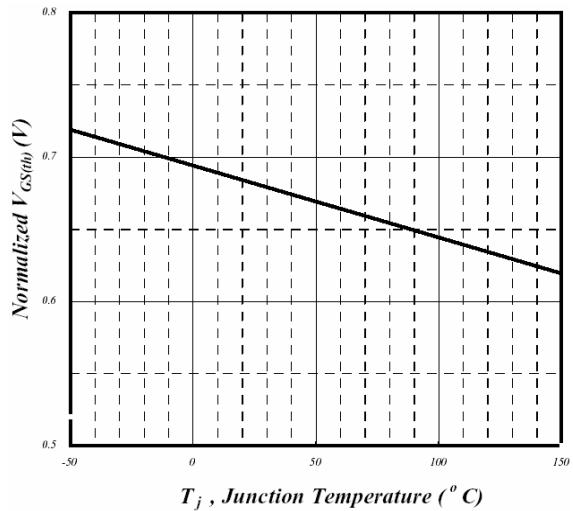

Fig 6. Gate Threshold Voltage v.s. Junction Temperature

N-Channel

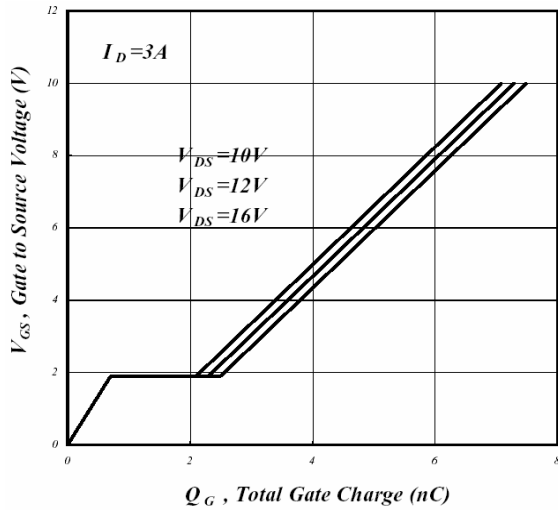

Fig 7. Gate Charge Characteristics

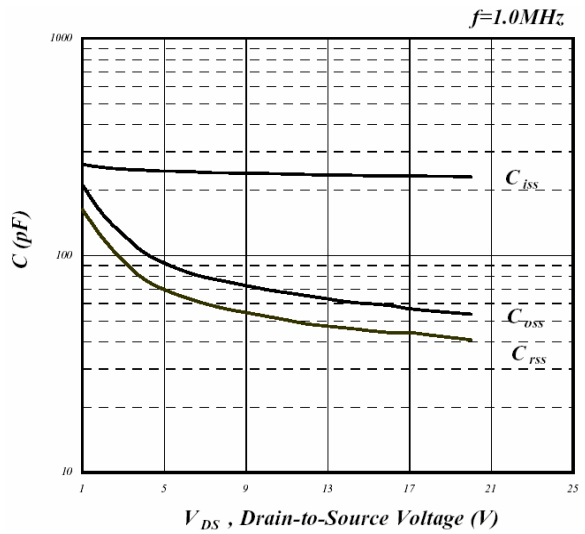

Fig 8. Typical Capacitance Characteristics

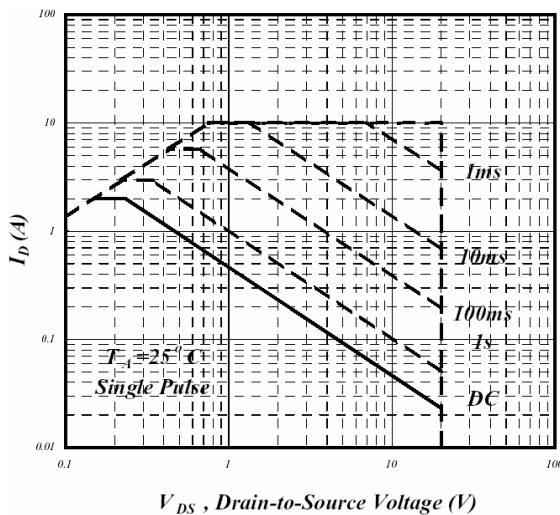

Fig 9. Maximum Safe Operating Area

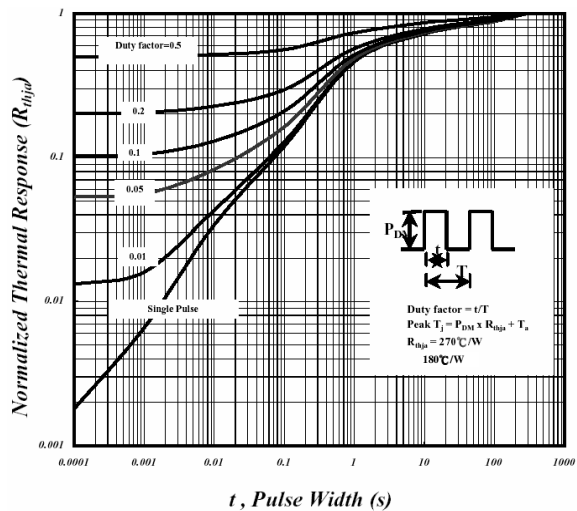

Fig 10. Effective Transient Thermal Impedance

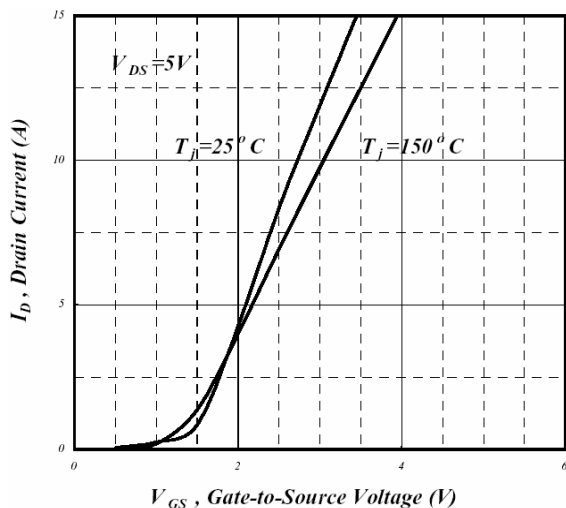

Fig 11. Transfer Characteristics

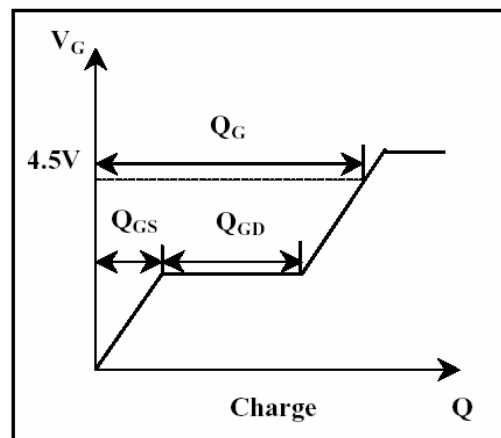

Fig 12. Gate Charge Waveform

P-Channel

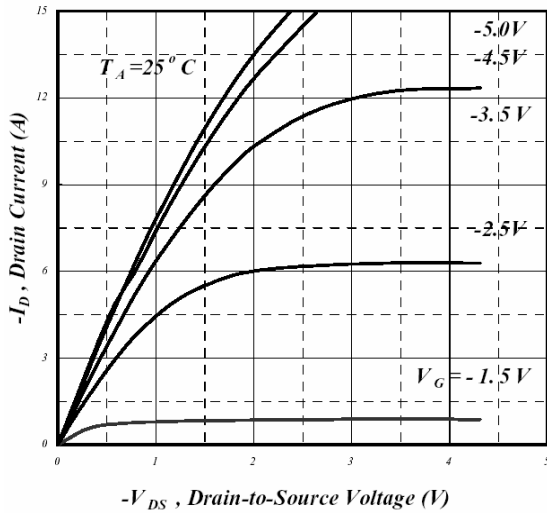

Fig 1. Typical Output Characteristics

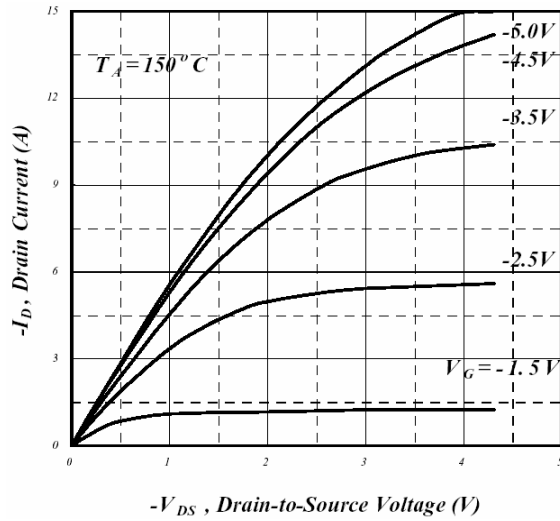

Fig 2. Typical Output Characteristics

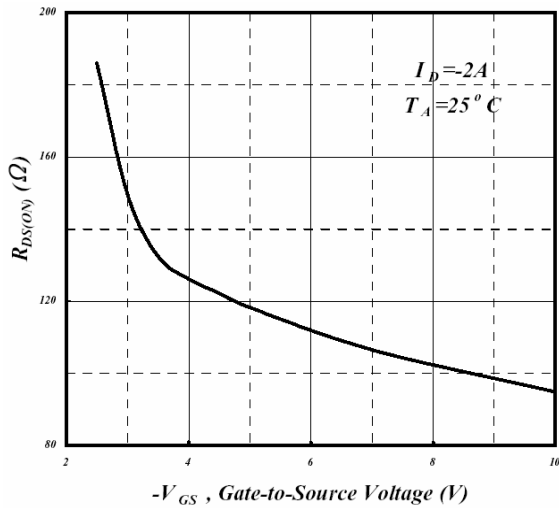

Fig 3. On-Resistance v.s. Gate Voltage

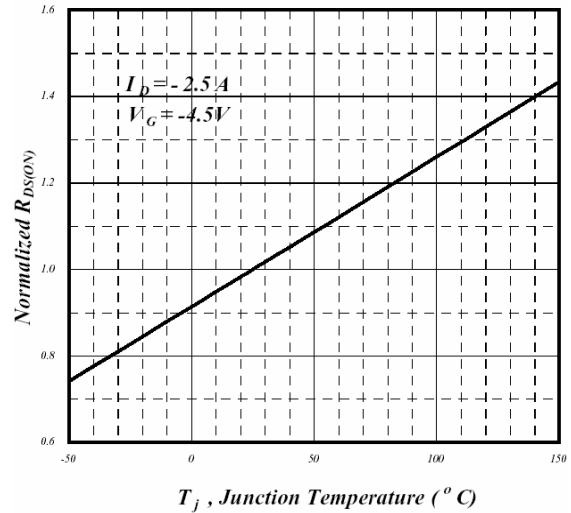

Fig 4. Normalized On-Resistance v.s. Junction Temperature

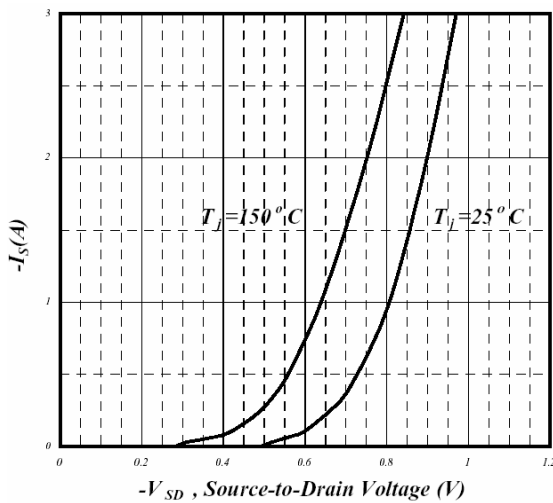

Fig 5. Forward Characteristics of Reverse Diode

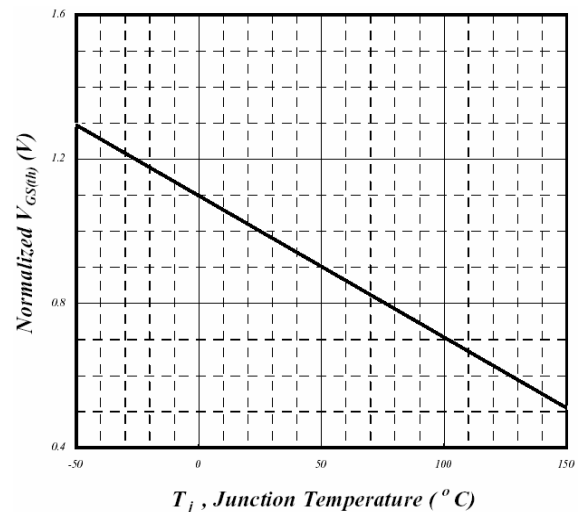

Fig 6. Gate Threshold Voltage v.s. Junction Temperature

P-Channel

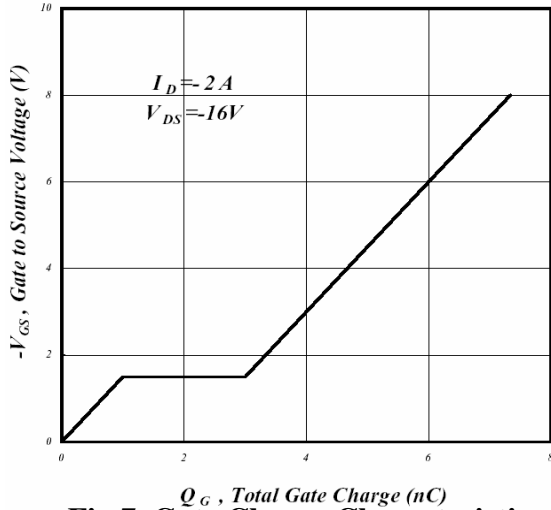

Fig 7. Gate Charge Characteristics

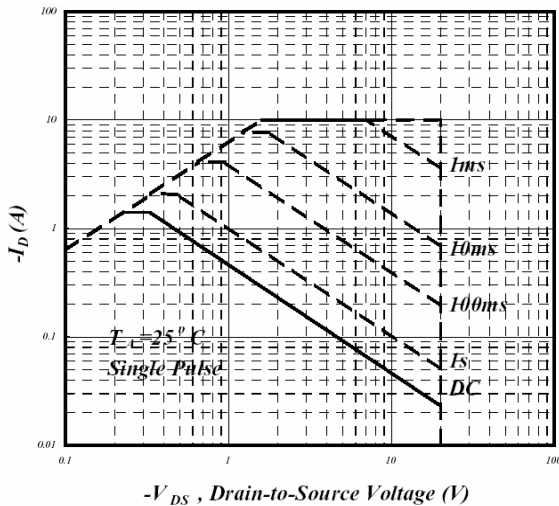

Fig 9. Maximum Safe Operating Area

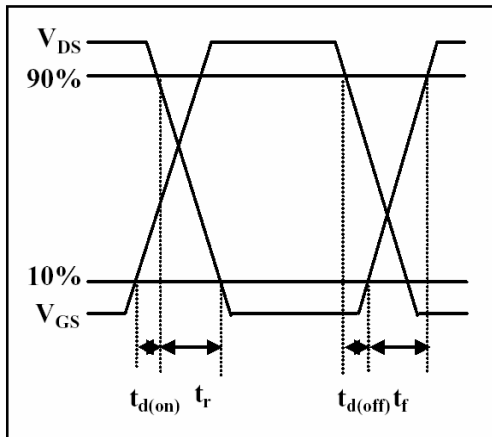

Fig 11. Switching Time Waveform

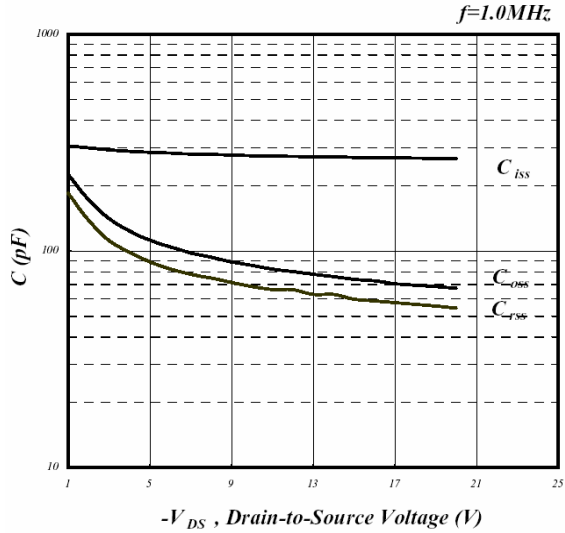

Fig 8. Typical Capacitance Characteristics

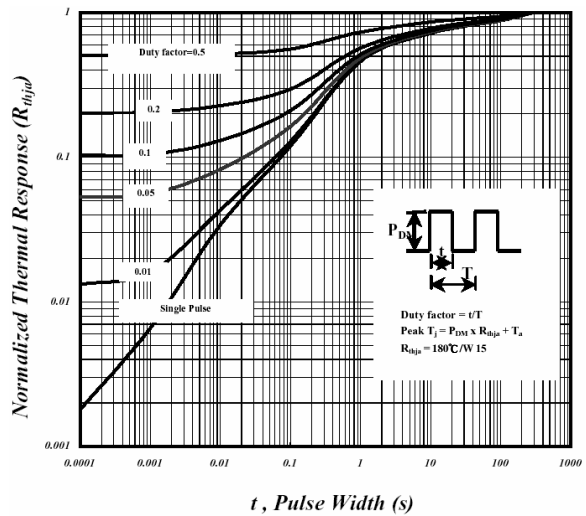

Fig 10. Effective Transient Thermal Impedance

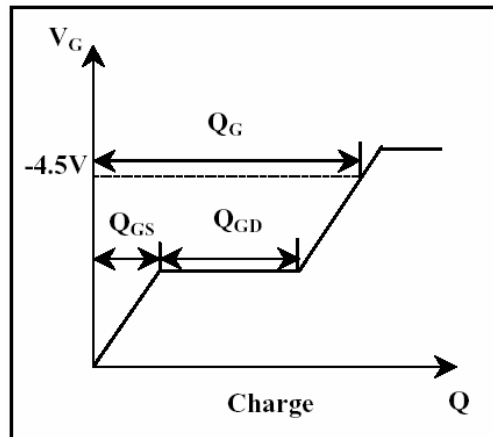

Fig 12. Gate Charge Waveform