

IRFHS9351PbF

HEXFET® Power MOSFET

V_{DS}	-30	V
$V_{GS\ max}$	±20	V
$R_{DS(on)\ max}$ (@ $V_{GS} = -10V$)	170	mΩ
I_D (@ $T_C = 25^\circ C$)	-3.4 ②	A

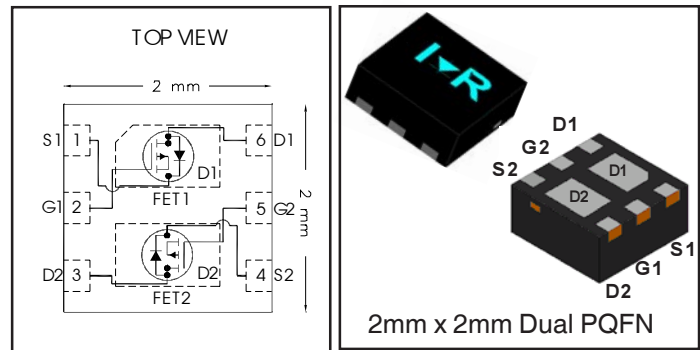

Applications

- Charge and Discharge Switch for Battery Application
- System/load switch

Features and Benefits

Features

Low $R_{DS(on)}$ ($\leq 170m\Omega$)
Low Thermal Resistance to PCB ($\leq 19^\circ C/W$)
Low Profile ($\leq 1.0\ mm$)
Compatible with Existing Surface Mount Techniques
RoHS Compliant Containing no Lead, no Bromide and no Halogen
MSL1, Consumer Qualification

results in

Benefits

Lower Conduction Losses
Enable better thermal dissipation
Increased Power Density
Easier Manufacturing
Environmentally Friendlier
Increased Reliability

Orderable part number	Package Type	Standard Pack		Note
		Form	Quantity	
IRFHS9351TRPBF	PQFN 2mm x 2mm	Tape and Reel	4000	
IRFHS9351TR2PBF	PQFN 2mm x 2mm	Tape and Reel	400	

Absolute Maximum Ratings

	Parameter	Max.	Units
V_{DS}	Drain-to-Source Voltage	-30	V
V_{GS}	Gate-to-Source Voltage	± 20	
I_D @ $T_A = 25^\circ C$	Continuous Drain Current, V_{GS} @ -10V	-2.3	A
I_D @ $T_A = 70^\circ C$	Continuous Drain Current, V_{GS} @ -10V	-1.5	
I_D @ $T_C = 25^\circ C$	Continuous Drain Current, V_{GS} @ -10V	-5.1 ②	
I_D @ $T_C = 70^\circ C$	Continuous Drain Current, V_{GS} @ -10V	-4.1 ②	
I_D @ $T_C = 25^\circ C$	Continuous Drain Current, V_{GS} @ 10V (Package Limited)	-3.4 ②	
I_{DM}	Pulsed Drain Current ①	-20	
P_D @ $T_A = 25^\circ C$	Power Dissipation ④	1.4	W
P_D @ $T_A = 70^\circ C$	Power Dissipation ④	0.9	
	Linear Derating Factor	0.01	W/°C
T_J T_{STG}	Operating Junction and Storage Temperature Range	-55 to + 150	°C

Notes ① through ⑥ are on page 2

Static @ $T_J = 25^\circ\text{C}$ (unless otherwise specified)

	Parameter	Min.	Typ.	Max.	Units	Conditions
BV_{DSS}	Drain-to-Source Breakdown Voltage	-30	—	—	V	$V_{GS} = 0V, I_D = -250\mu A$
V_{DSS}/T_J	Breakdown Voltage Temp. Coefficient	—	0.02	—	V/ $^\circ\text{C}$	Reference to $25^\circ\text{C}, I_D = -1\text{mA}$
$R_{DS(on)}$	Static Drain-to-Source On-Resistance	—	135	170	m	$V_{GS} = -10V, I_D = -3.1A$ ③
		—	235	290		$V_{GS} = -4.5V, I_D = -2.5A$ ③
$V_{GS(th)}$	Gate Threshold Voltage	-1.3	-1.8	-2.4	V	$V_{DS} = V_{GS}, I_D = -10\mu A$
$V_{GS(th)}$	Gate Threshold Voltage Coefficient	—	-4.6	—	mV/ $^\circ\text{C}$	
I_{DSS}	Drain-to-Source Leakage Current	—	—	-1.0	μA	$V_{DS} = -24V, V_{GS} = 0V$
		—	—	-150		$V_{DS} = -24V, V_{GS} = 0V, T_J = 125^\circ\text{C}$
I_{GSS}	Gate-to-Source Forward Leakage	—	—	-100	nA	$V_{GS} = -20V$
	Gate-to-Source Reverse Leakage	—	—	100		$V_{GS} = 20V$
g_{fs}	Forward Transconductance	2.4	—	—	S	$V_{DS} = -10V, I_D = -3.1A$
Q_g	Total Gate Charge ⑥	—	1.9	—	nC	$V_{DS} = -15V, V_{GS} = -4.5V, I_D = -3.1A$
Q_g	Total Gate Charge ⑥	—	3.7	—	nC	$V_{GS} = -10V$
Q_{gs}	Gate-to-Source Charge ⑥	—	0.6	—		$V_{DS} = -15V$
Q_{gd}	Gate-to-Drain Charge ⑥	—	1.1	—		$I_D = -3.1A$
R_G	Gate Resistance ⑥	—	17	—		
$t_{d(on)}$	Turn-On Delay Time	—	8.3	—	ns	$V_{DD} = -15V, V_{GS} = -4.5V$ ③ $I_D = -3.1A$ $R_G = 1.8$ See Figs. 19a & 19b
t_r	Rise Time	—	30	—		
$t_{d(off)}$	Turn-Off Delay Time	—	6.3	—		
t_f	Fall Time	—	7.9	—		
C_{iss}	Input Capacitance	—	160	—	pF	$V_{GS} = 0V$
C_{oss}	Output Capacitance	—	39	—		$V_{DS} = -25V$
C_{rss}	Reverse Transfer Capacitance	—	26	—		$f = 1.0\text{KHz}$

Diode Characteristics

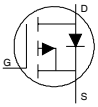
	Parameter	Min.	Typ.	Max.	Units	Conditions
I_S	Continuous Source Current (Body Diode)	—	—	-5.1	A	MOSFET symbol showing the integral reverse p-n junction diode. 
I_{SM}	Pulsed Source Current (Body Diode) ①	—	—	-20		
V_{SD}	Diode Forward Voltage	—	—	-1.2	V	$T_J = 25^\circ\text{C}, I_S = -3.1A, V_{GS} = 0V$ ③
t_{rr}	Reverse Recovery Time	—	20	30	ns	$T_J = 25^\circ\text{C}, I_F = -3.1A, V_{DD} = -15V$
Q_{rr}	Reverse Recovery Charge	—	42	63	nC	$di/dt = 370/\mu s$ ③

Thermal Resistance

	Parameter	Typ.	Max.	Units
R_{JC} (Bottom)	Junction-to-Case ②	—	19	$^\circ\text{C/W}$
R_{JC} (Top)	Junction-to-Case ②	—	170	
R_{JA}	Junction-to-Ambient ④	—	90	
R_{JA}	Junction-to-Ambient ($t < 10s$) ④	—	75	

Notes:

- ① Repetitive rating; pulse width limited by max. junction temperature.
- ② Current limited by package. .
- ③ Pulse width $\leq 400\mu s$; duty cycle $\leq 2\%$.
- ④ When mounted on 1 inch square copper board.
- ⑤ R_{θ} is measured at T_J of approximately 90°C .
- ⑥ For DESIGN AID ONLY, not subject to production testing.

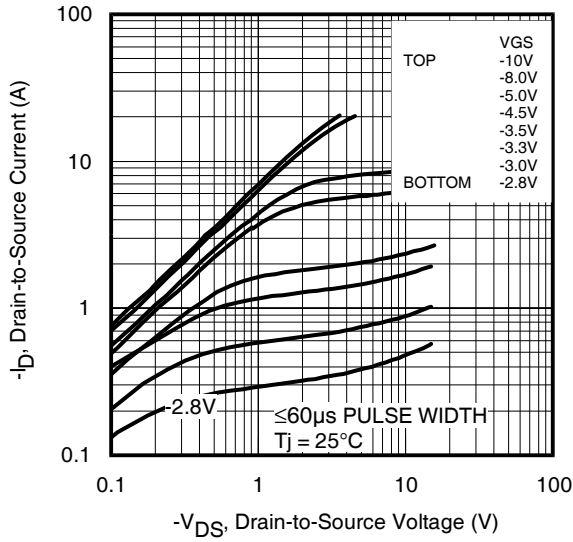

Fig 1. Typical Output Characteristics

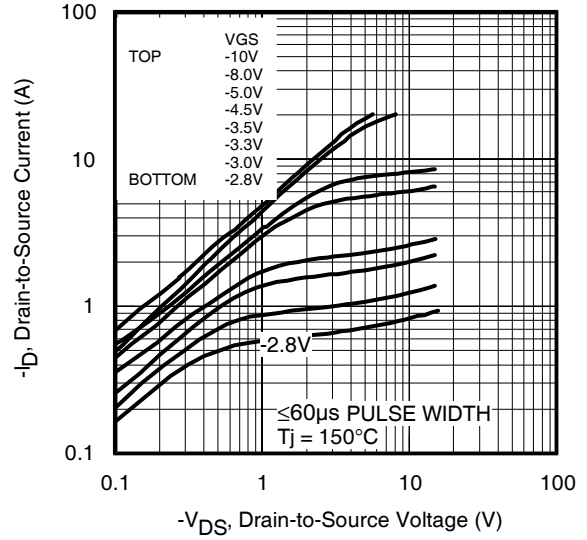

Fig 2. Typical Output Characteristics

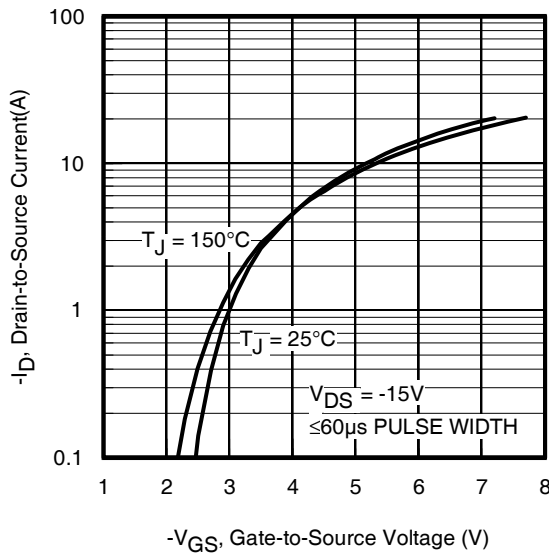

Fig 3. Typical Transfer Characteristics

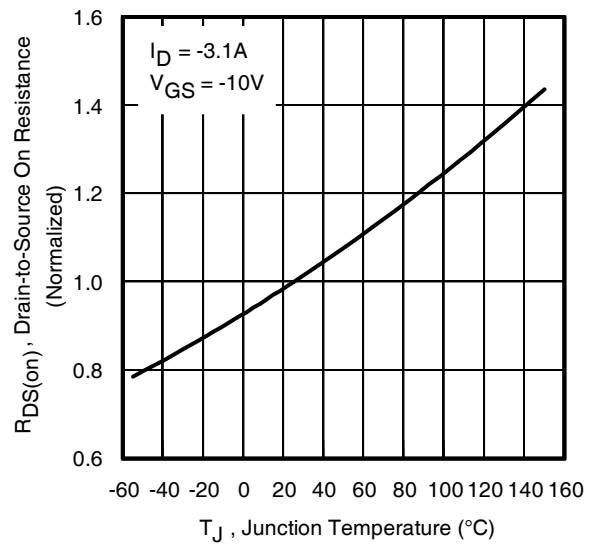

Fig 4. Normalized On-Resistance vs. Temperature

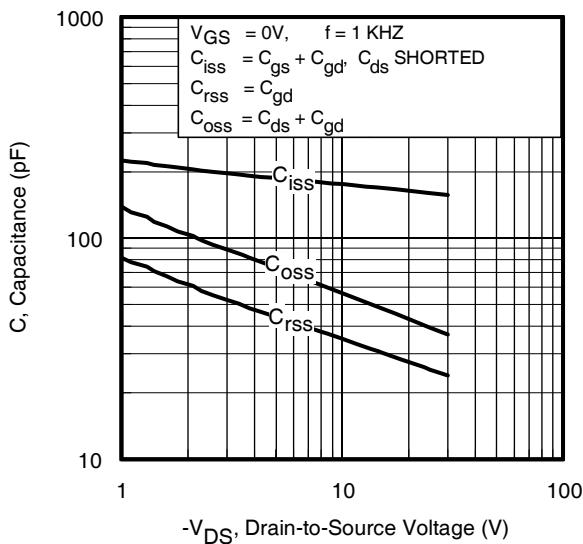

Fig 5. Typical Capacitance vs. Drain-to-Source Voltage
www.irf.com

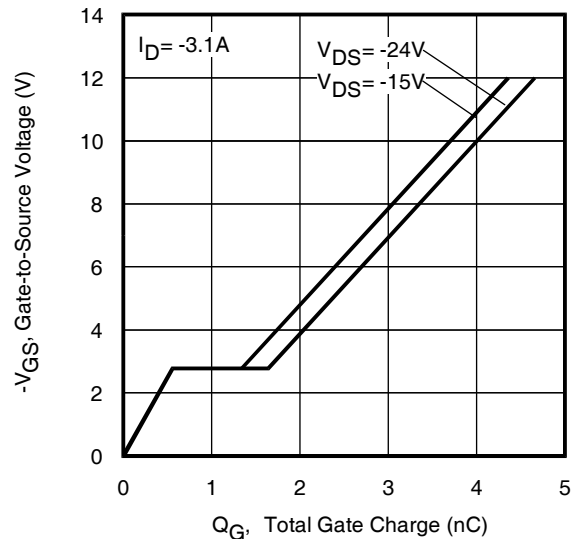

Fig 6. Typical Gate Charge vs. Gate-to-Source Voltage

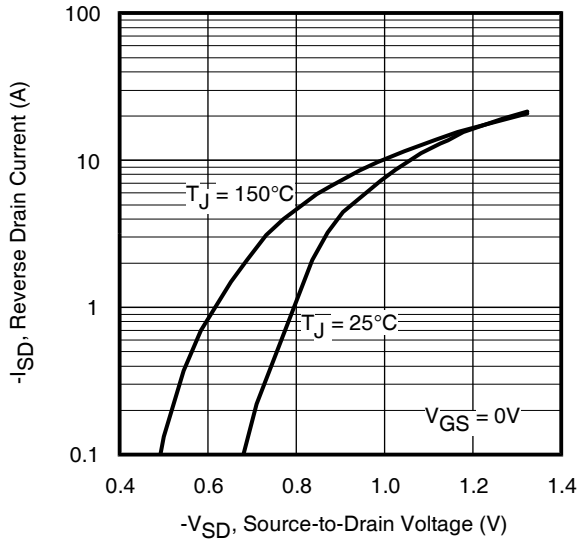

Fig 7. Typical Source-Drain Diode Forward Voltage

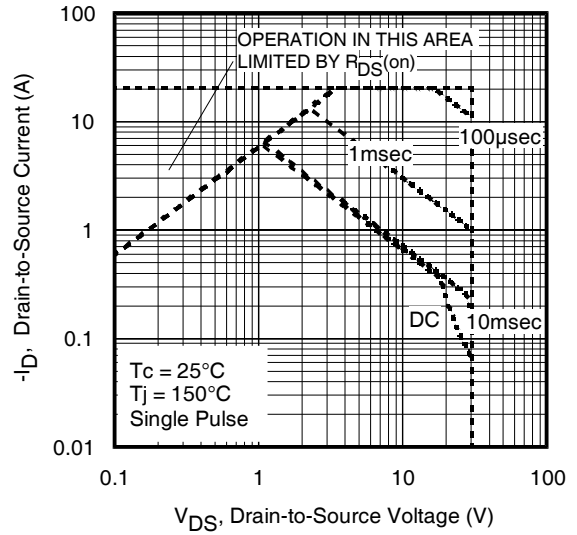

Fig 8. Maximum Safe Operating Area

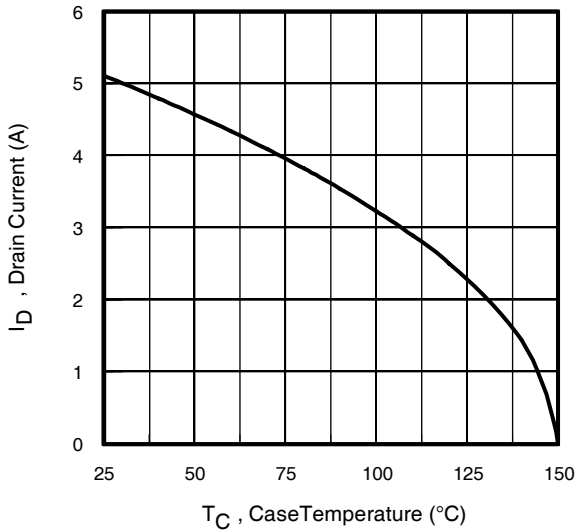

Fig 9. Maximum Drain Current vs. Case Temperature

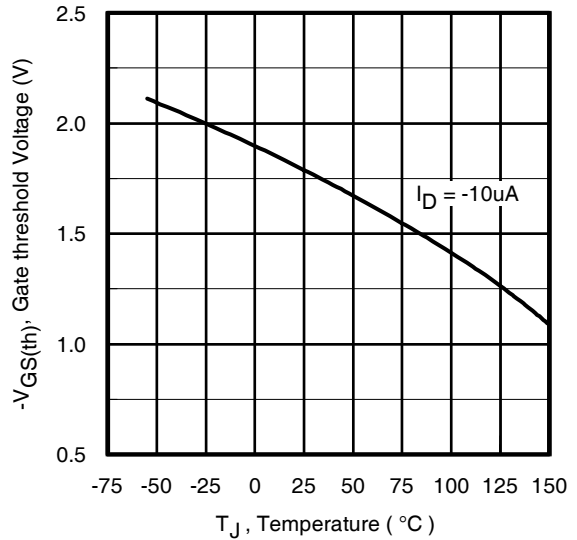

Fig 10. Threshold Voltage vs. Temperature

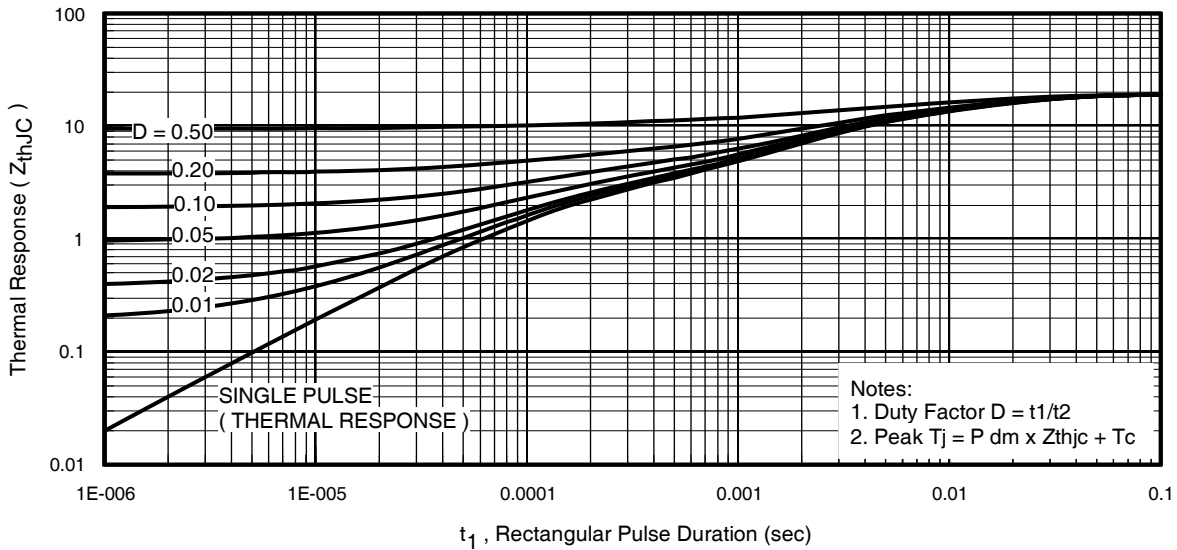

Fig 11. Maximum Effective Transient Thermal Impedance, Junction-to-Case

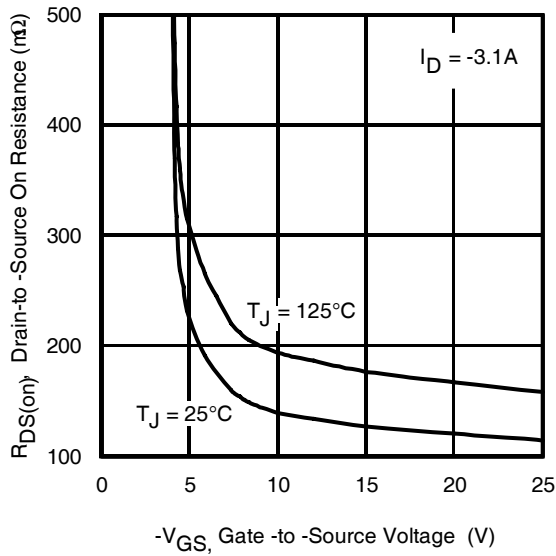

Fig 12. On-Resistance vs. Gate Voltage

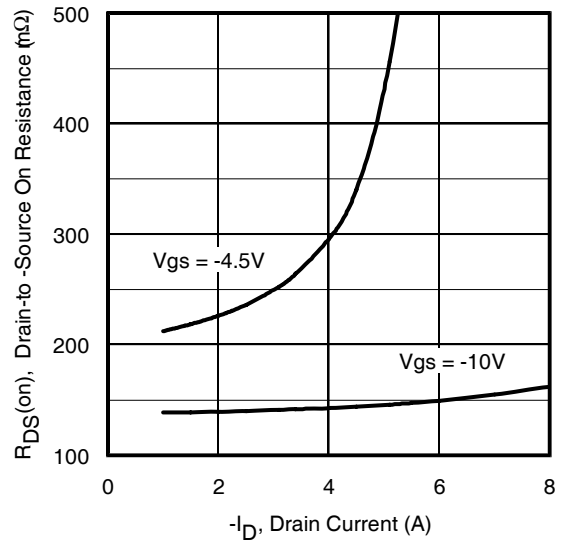

Fig 13. Typical On-Resistance vs. Drain Current

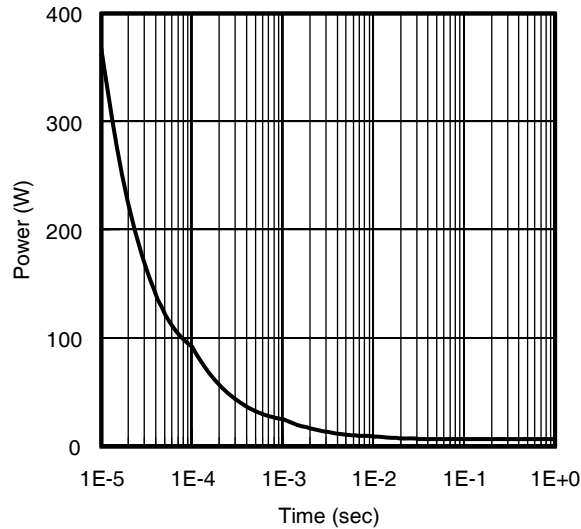
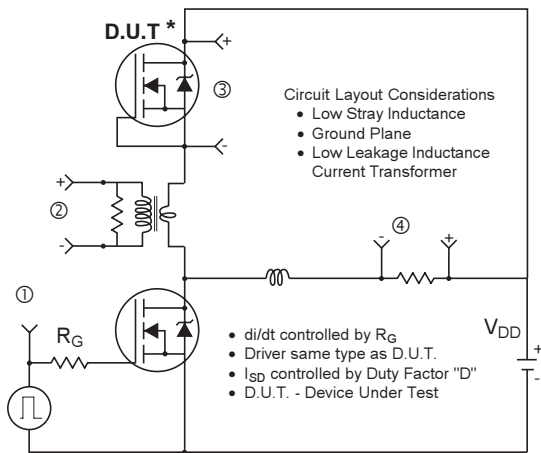
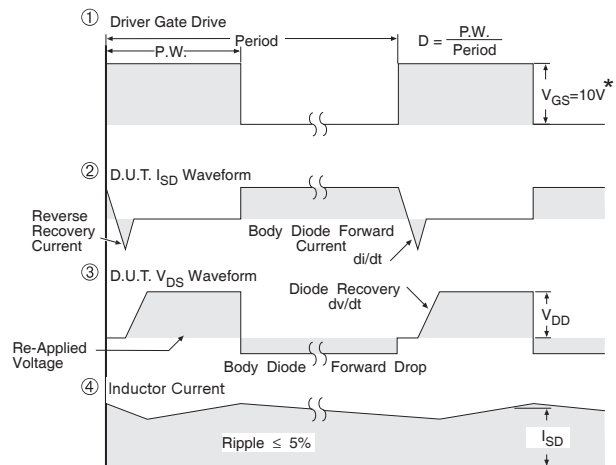

Fig 14. Typical Power vs. Time



* Reverse Polarity of D.U.T. for P-Channel



* $V_{GS} = 5V$ for Logic Level Devices

Fig 15. Diode Reverse Recovery Test Circuit for P-Channel HEXFET® Power MOSFETs

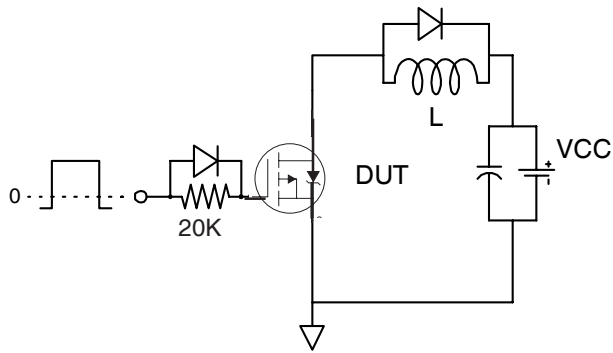

Fig 16a. Gate Charge Test Circuit

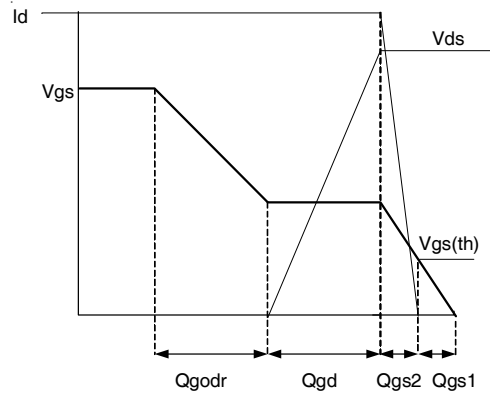

Fig 16b. Gate Charge Waveform

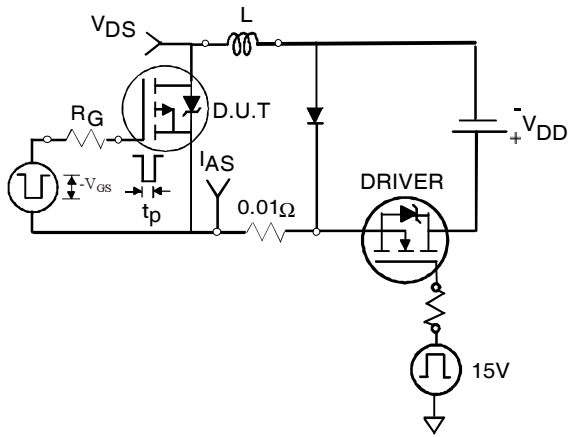

Fig 17a. Unclamped Inductive Test Circuit

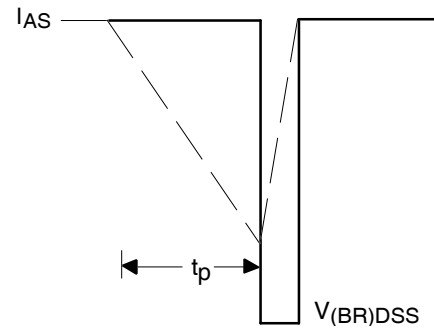

Fig 17b. Unclamped Inductive Waveforms

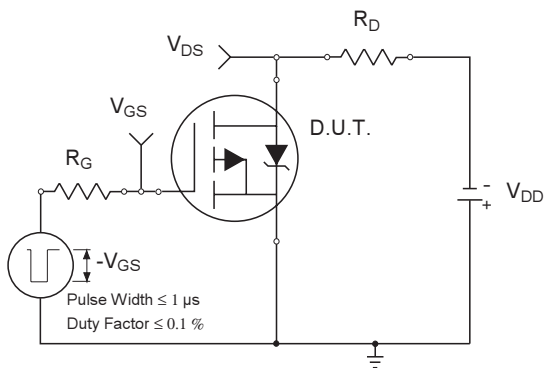

Fig 18a. Switching Time Test Circuit

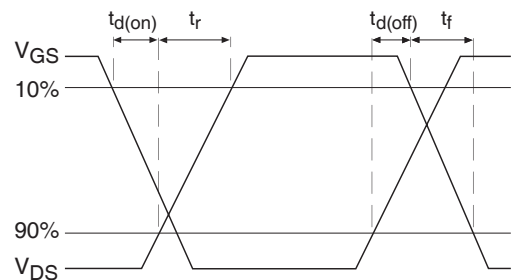
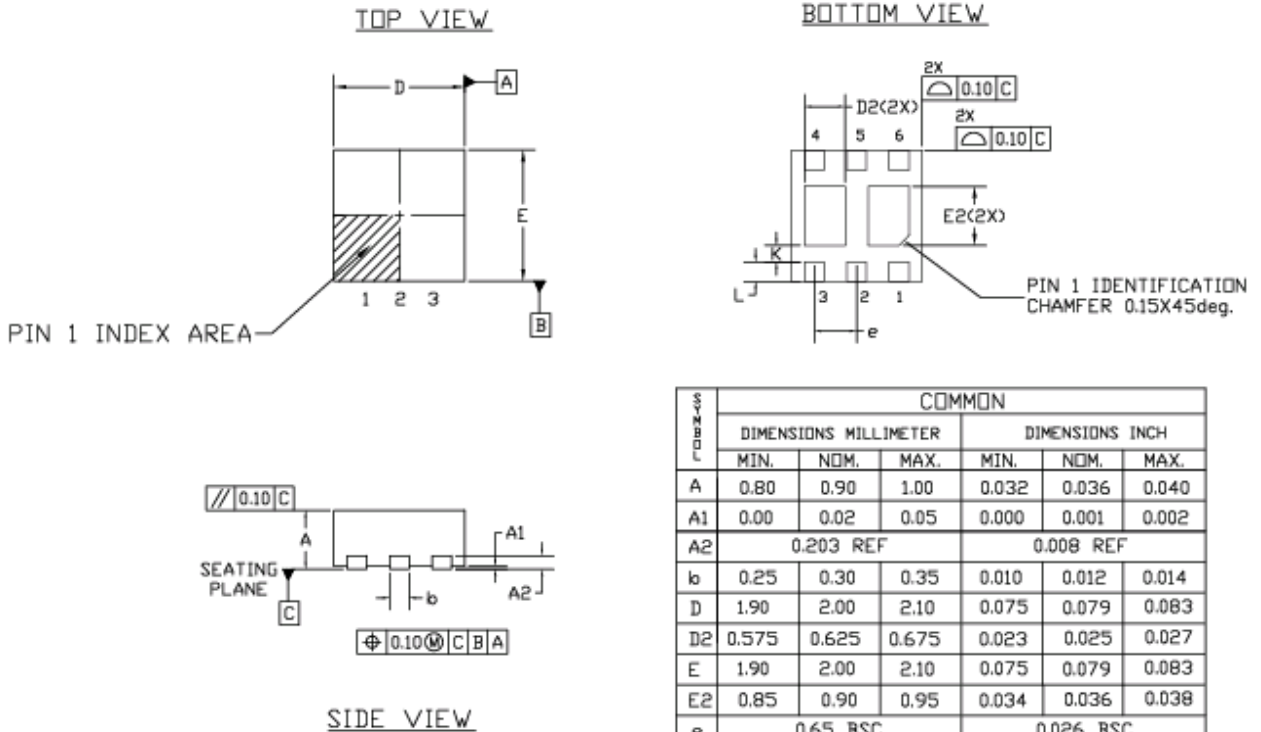

Fig 18b. Switching Time Waveforms

PQFN Package Details



SYMBOL	COMMON					
	DIMENSIONS MILLIMETER			DIMENSIONS INCH		
	MIN.	NOM.	MAX.	MIN.	NOM.	MAX.
A	0.80	0.90	1.00	0.032	0.036	0.040
A1	0.00	0.02	0.05	0.000	0.001	0.002
A2	0.203 REF			0.008 REF		
b	0.25	0.30	0.35	0.010	0.012	0.014
D	1.90	2.00	2.10	0.075	0.079	0.083
D2	0.575	0.625	0.675	0.023	0.025	0.027
E	1.90	2.00	2.10	0.075	0.079	0.083
E2	0.85	0.90	0.95	0.034	0.036	0.038
e	0.65 BSC			0.026 BSC		
L	0.25	0.30	0.35	0.010	0.012	0.014
K	0.25	-	-	0.010	-	-

NOTES :

1. DIMENSION AND TOLERANCING CONFORM TO ASME Y14.5M-1994.
2. CONTROLLING DIMENSIONS : MILLIMETER. CONVERTED INCH DIMENSION ARE NOT NECESSARILY EXACT.

PQFN Part Marking

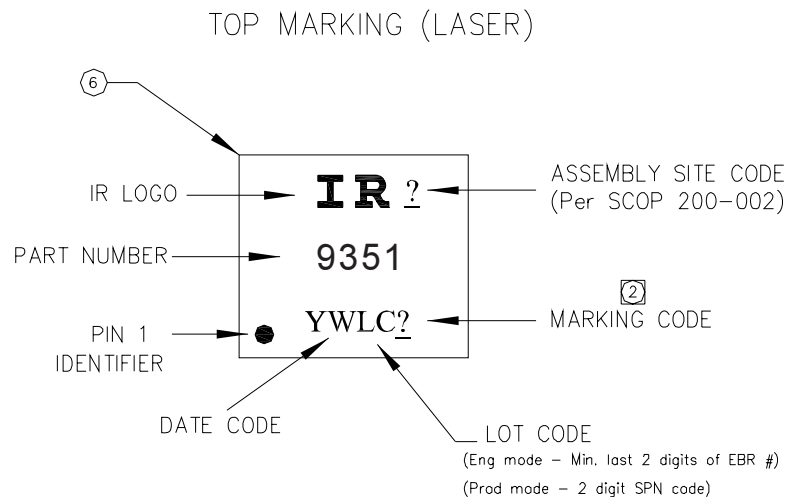

Note: For the most current drawing please refer to IR website at: <http://www.irf.com/package/>

IRFHS9351PbF

PQFN Tape and Reel

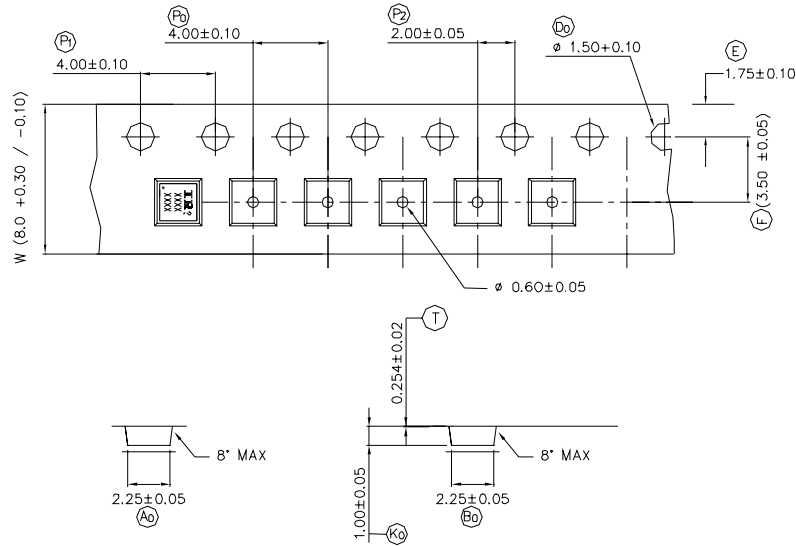

NOTE: The Surface Resistivity is $10^4 - 10^8$ OHM/SQ

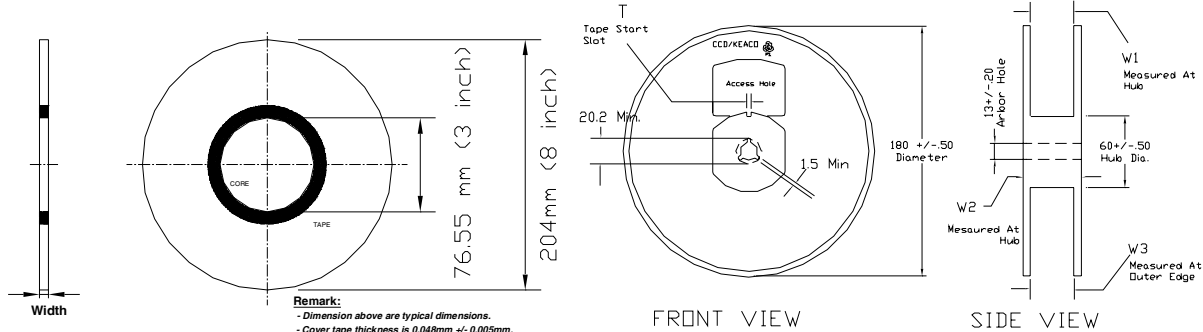

Remark:
- Dimension above are typical dimensions.
- Cover tape thickness is 0.04mm +/- 0.005mm.
- Surface resistivity 10ES < Rs < 10ER.

COVER TAPE (WIDTH)	TOLERANCE
5.4 mm	+/- 0.1 mm
9.5 mm	+/- 0.1 mm

TABLE 3: REEL DETAILS

TAPE WIDTH	T	W1	W2	W3	PART NO
8 MM	3 ± 0.50	8.4 ^{+1.5} _{-3.0}	14.4 Max	7.90 Min 10.9 Max	91586-1
12 MM	3 ± 0.50	12.4 ^{+2.0} _{-0.0}	18.4 Max	11.9 Min 15.4 Max	91586-2

Note: Surface resistivity is $\geq 1 \times 10^5$ but $< 1 \times 10^{12}$ ohm/sq.

Qualification information[†]

Qualification level	Consumer ^{††} (per JEDEC JESD47F ^{†††} guidelines)	
Moisture Sensitivity Level	PQFN 2mm x 2mm	MSL1 (per IPC/JEDEC J-STD-020D ^{†††})
RoHS compliant	Yes	

[†] Qualification standards can be found at International Rectifier's web site

<http://www.irf.com/product-info/reliability>

^{††} Higher qualification ratings may be available should the user have such requirements.

Please contact your International Rectifier sales representative for further information:

<http://www.irf.com/whoto-call/salesrep/>

^{†††} Applicable version of JEDEC standard at the time of product release.

Data and specifications subject to change without notice.