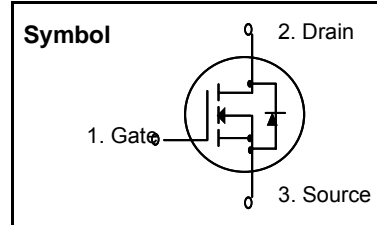


## N-Channel MOSFET

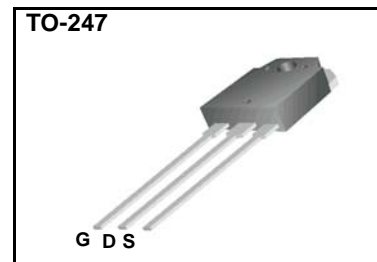
### Features

- $R_{DS(on)}$  (Max 0.26  $\Omega$ ) @  $V_{GS}=10V$
- Gate Charge (Typical 90nC)
- Improved dv/dt Capability, High Ruggedness
- 100% Avalanche Tested
- Maximum Junction Temperature Range (150°C)



### General Description

This Power MOSFET is produced using Wisdom's advanced planar stripe, DMOS technology. This latest technology has been especially designed to minimize on-state resistance, have a high rugged avalanche characteristics. These devices are well suited for high efficiency switch mode power supplies, active power factor correction, electronic lamp ballasts based on half bridge topology.



### Absolute Maximum Ratings

Symbol	Parameter	Value	Units
$V_{DSS}$	Drain to Source Voltage	500	V
$I_D$	Continuous Drain Current(@ $T_C = 25^\circ C$ )	20	A
	Continuous Drain Current(@ $T_C = 100^\circ C$ )	13	A
$I_{DM}$	Drain Current Pulsed (Note 1)	80	A
$V_{GS}$	Gate to Source Voltage	$\pm 30$	V
$E_{AS}$	Single Pulsed Avalanche Energy (Note 2)	1110	mJ
$E_{AR}$	Repetitive Avalanche Energy (Note 1)	25.0	mJ
dv/dt	Peak Diode Recovery dv/dt (Note 3)	4.5	V/ns
$P_D$	Total Power Dissipation(@ $T_C = 25^\circ C$ )	250	W
	Derating Factor above 25 °C	2.00	W/°C
$T_{STG}, T_J$	Operating Junction Temperature & Storage Temperature	- 55 ~ 150	°C
$T_L$	Maximum Lead Temperature for soldering purpose, 1/8 from Case for 5 seconds.	300	°C

### Thermal Characteristics

Symbol	Parameter	Value			Units
		Min.	Typ.	Max.	
$R_{\theta JC}$	Thermal Resistance, Junction-to-Case	-	-	0.50	°C/W
$R_{\theta CS}$	Thermal Resistance, Case to Sink	-	0.24	-	°C/W
$R_{\theta JA}$	Thermal Resistance, Junction-to-Ambient	-	-	40	°C/W

# WFW20N50

## Electrical Characteristics (T<sub>C</sub> = 25 °C unless otherwise noted)

Symbol	Parameter	Test Conditions	Min	Typ	Max	Units
<b>Off Characteristics</b>						
BV <sub>DSS</sub>	Drain-Source Breakdown Voltage	V <sub>GS</sub> = 0V, I <sub>D</sub> = 250uA	500	-	-	V
$\Delta BV_{DSS} / \Delta T_J$	Breakdown Voltage Temperature coefficient	I <sub>D</sub> = 250uA, referenced to 25 °C	-	0.6	-	V/°C
I <sub>DSS</sub>	Drain-Source Leakage Current	V <sub>DS</sub> = 500V, V <sub>GS</sub> = 0V	-	-	10	uA
		V <sub>DS</sub> = 400V, T <sub>C</sub> = 125 °C	-	-	100	uA
I <sub>GSS</sub>	Gate-Source Leakage, Forward	V <sub>GS</sub> = 30V, V <sub>DS</sub> = 0V	-	-	100	nA
	Gate-source Leakage, Reverse	V <sub>GS</sub> = -30V, V <sub>DS</sub> = 0V	-	-	-100	nA
<b>On Characteristics</b>						
V <sub>GS(th)</sub>	Gate Threshold Voltage	V <sub>DS</sub> = V <sub>GS</sub> , I <sub>D</sub> = 250uA	2.0	-	4.0	V
R <sub>DS(ON)</sub>	Static Drain-Source On-state Resistance	V <sub>GS</sub> = 10 V, I <sub>D</sub> = 10A	-	0.21	0.26	Ω
gfs	Forward Transconductance	V <sub>DS</sub> = 50V, I <sub>D</sub> = 10.0A	-	15	-	S
<b>Dynamic Characteristics</b>						
C <sub>iss</sub>	Input Capacitance	V <sub>GS</sub> = 0 V, V <sub>DS</sub> = 25V, f = 1MHz	-	3350	-	pF
C <sub>oss</sub>	Output Capacitance		-	490	-	
C <sub>rss</sub>	Reverse Transfer Capacitance		-	50	-	
<b>Dynamic Characteristics</b>						
t <sub>d(on)</sub>	Turn-on Delay Time	V <sub>DD</sub> = 250V, I <sub>D</sub> = 20.0A, R <sub>G</sub> = 25Ω (Note 4, 5)	-	60	-	ns
t <sub>r</sub>	Rise Time		-	210	-	
t <sub>d(off)</sub>	Turn-off Delay Time		-	170	-	
t <sub>f</sub>	Fall Time		-	130	-	
Q <sub>g</sub>	Total Gate Charge	V <sub>DS</sub> = 400V, V <sub>GS</sub> = 10V, I <sub>D</sub> = 20.0A (Note 4, 5)	-	90	-	nC
Q <sub>gs</sub>	Gate-Source Charge		-	20	-	
Q <sub>gd</sub>	Gate-Drain Charge(Miller Charge)		-	42	-	

## Source-Drain Diode Ratings and Characteristics

Symbol	Parameter	Test Conditions	Min.	Typ.	Max.	Unit.
I <sub>S</sub>	Continuous Source Current	Integral Reverse p-n Junction Diode in the MOSFET	-	-	20	A
I <sub>SM</sub>	Pulsed Source Current		-	-	80	
V <sub>SD</sub>	Diode Forward Voltage	I <sub>S</sub> = 20.0A, V <sub>GS</sub> = 0V	-	-	1.4	V
t <sub>rr</sub>	Reverse Recovery Time	I <sub>S</sub> = 20.0A, V <sub>GS</sub> = 0V, dI <sub>F</sub> /dt = 100A/us	-	370	-	ns
* Q <sub>RES</sub>	Reverse Recovery Charge		-	380	-	nC

- \* NOTES
1. Repeatability rating : pulse width limited by junction temperature
  2. L = 5.0mH, I<sub>AS</sub> = 20.0A, V<sub>DD</sub> = 50V, R<sub>G</sub> = 25Ω, Starting T<sub>J</sub> = 25°C
  3. I<sub>SD</sub> ≤ 20.0A, di/dt ≤ 200A/us, V<sub>DD</sub> ≤ BV<sub>DSS</sub>, Starting T<sub>J</sub> = 25°C
  4. Pulse Test : Pulse Width ≤ 300us, Duty Cycle ≤ 2%
  5. Essentially independent of operating temperature.

# Typical Characteristics

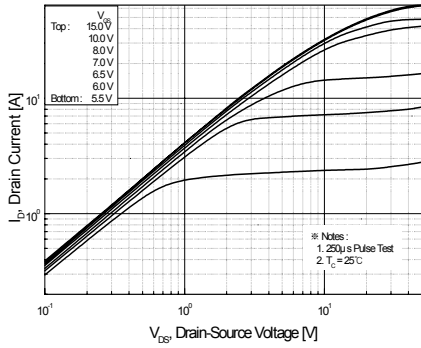


Figure 1. On-Region Characteristics

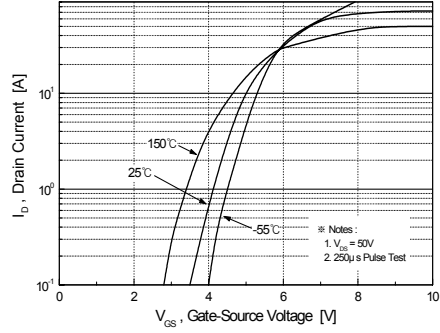


Figure 2. Transfer Characteristics

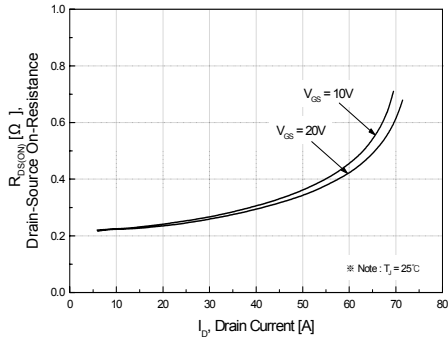


Figure 3. On-Resistance Variation vs. Drain Current and Gate Voltage

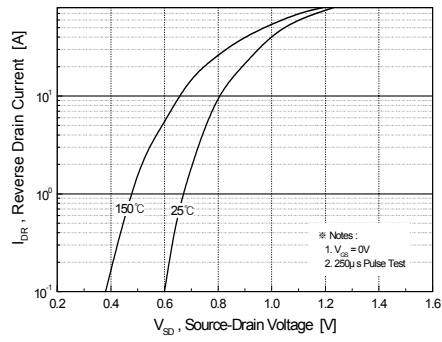


Figure 4. Body Diode Forward Voltage Variation vs. Source Current and Temperature

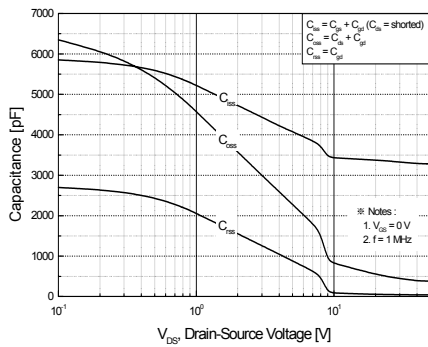


Figure 5. Capacitance Characteristics

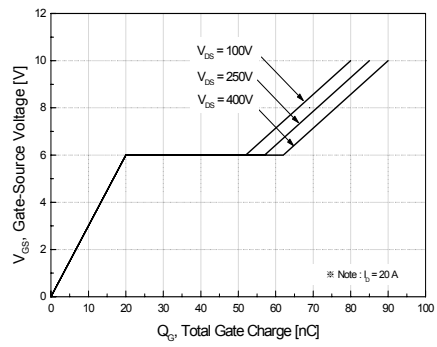
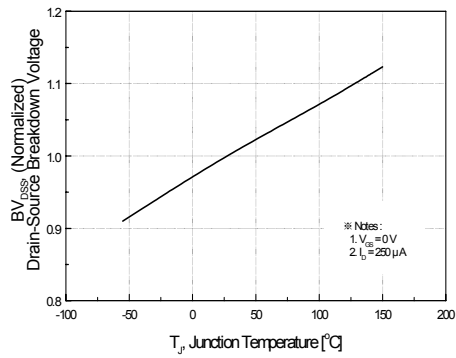
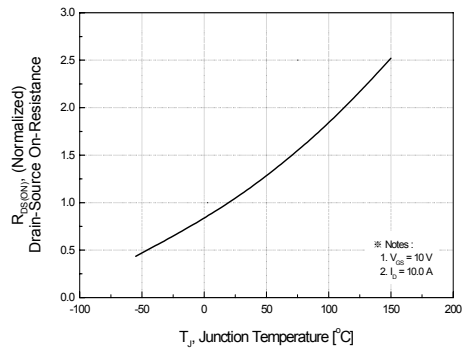


Figure 6. Gate Charge Characteristics

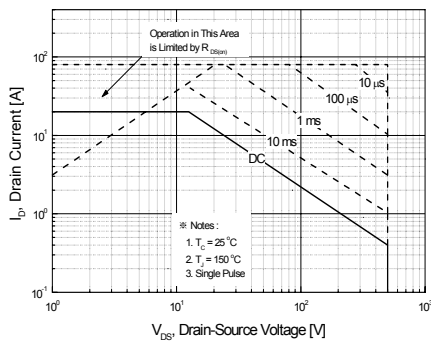
## Typical Characteristics (Continued)



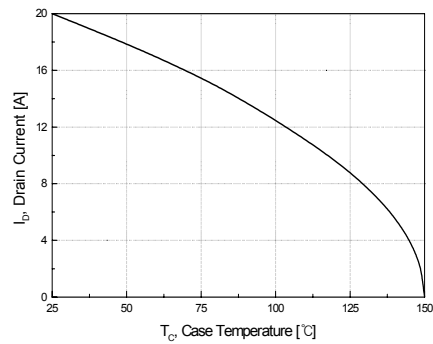
**Figure 7. Breakdown Voltage Variation vs. Temperature**



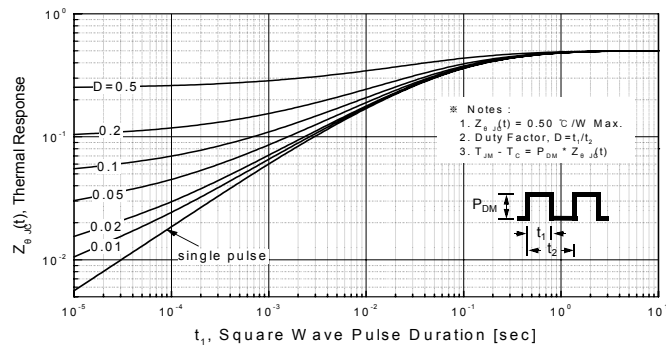
**Figure 8. On-Resistance Variation vs. Temperature**



**Figure 9. Maximum Safe Operating Area**

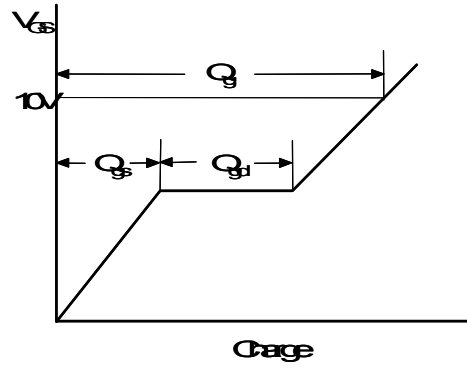
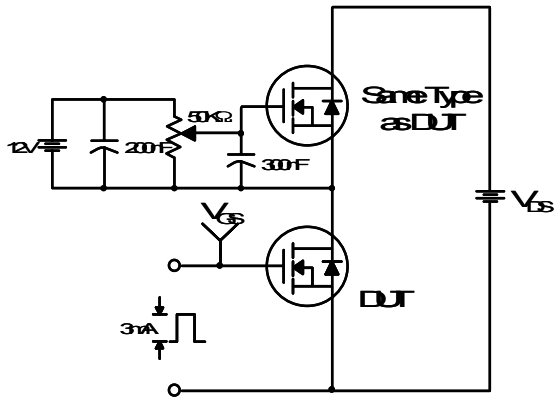


**Figure 10. Maximum Drain Current vs. Case Temperature**

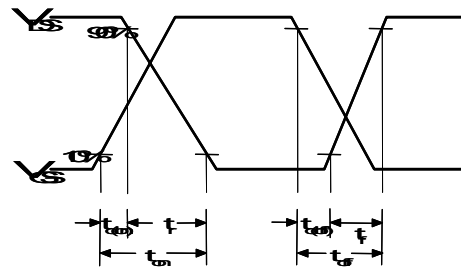
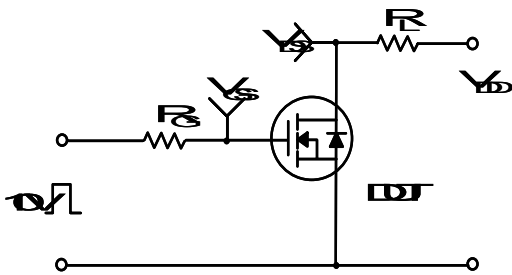


**Figure 11. Transient Thermal Response Curve**

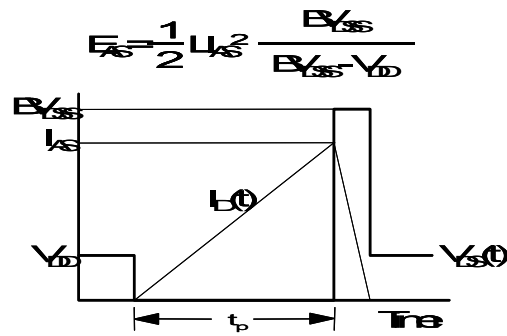
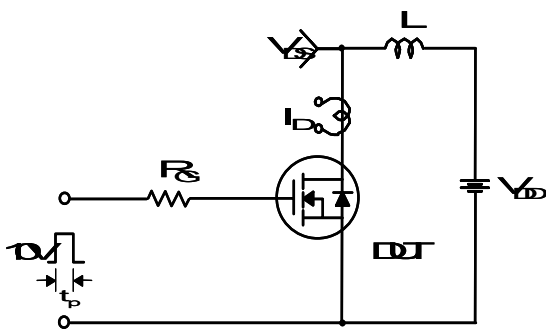
### Gate Charge Test Circuit & Waveform



### Resistive Switching Test Circuit & Waveforms



### Unclamped Inductive Switching Test Circuit & Waveforms





Package Dimensions

TO-247

