

03

fi-5530C/fi-5530C2

Image Scanner

Maintenance Manual

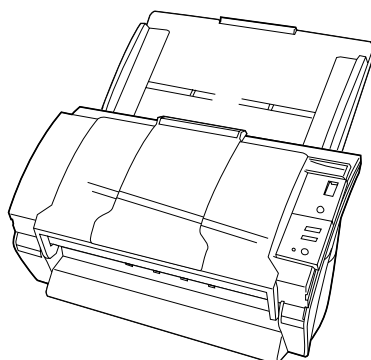

05	Nov.20, 2008	K.Okada	T.Anzai	IFujioka	Refer to Revision Record on page 2.	TITLE	fi-5530C/fi-5530C2 IMAGE SCANNER MAINTENANCE MANUAL		
04	July 7, 2008	K.Okada	T.Anzai	IFujioka	Refer to Revision Record on page 2.				
03	Feb.23 2007	K.Okada	K.Oakda	T.Anzai	Refer to Revision Record on page 2.				
						DRAW. No.	P1PA03334-B30X/6	CUST.	
Rev	DATE	DESIG.	CHECK	APPR.	DESCRIPTION	PFU LIMITED		PAGE	1/138
DESIG	Aug.19, 2005	K.Okada	CHECK	K.Okada	APPR. T.Anzai				

Revision Record		
Edition	Date published	Revised contents
Draft 01	May 27, 2005	Draft 01 released
Draft 02	July 8, 2005	Draft 02 released
01	August 19, 2005	01 version released.
02	February 20, 2006	P39, 117, 123, 125, 126: For RoHS compliance, etc. P117. 131: "AC Cordset UK" added.
03	February 23, 2007	P1,4,8,10,24,37,38,113-116,123,128,129,131,135: Descriptions of fi-5530C2 added.
04	July 7, 2008	P3: Part numbers of fi-5530C2 manuals added. P4: Operating systems for fi-5530C2 added. P72: Description in replacement procedure deleted. P95: Procedure in Paper feeding test added.
05	November 20, 2008	P114: Emulation mode description changed.

The contents of this manual are subject to change without prior notice.

All rights reserved, Copyright© PFU LIMITED, 2005-2008

05	Nov. 20, 2008	K.Okada	T.Anzai	I.Fujioka	Refer to Revision Record on page 2.	TITLE fi-5530C/fi-5530C2 IMAGE SCANNER MAINTENANCE MANUAL	DRAW. No. P1PA03334-B30X/6	CUST.
04	July 7, 2008	K.Okada	T.Anzai	I.Fujioka	Refer to Revision Record on page 2.			
03	Feb.23, 2007	K.Okada	K.Okada	T.Anzai	Refer to Revision Record on page 2.			
Rev	DATE	DESIG.	CHECK	APPR.	DESCRIPTION	PFU LIMITED		PAGE 2/138
DESIG	Aug.19, 2005	K.Okada	CHECK	K.Okada	APPR. T.Anzai			

Preface

This manual provides the technical information such as maintenance, troubleshooting procedure and parts replacement procedure for field Engineers on fi-5530C/fi-5530C2 image scanner.

This manual should be used for maintenance only. 03

For information that is not contained in this manual, refer to the following manuals:

Item	Manuals	P/N *	Remarks
1	fi-5530C Operator's Guide	P3PC-1352-**EN	A CD-ROM, attached to scanner
2	fi-5530C Getting Started	P3PC-1342-**EN	A booklet, attached to scanner
03	3	fi-5530C/fi-5530C2 Illustrated Parts Catalog	P4PA03334-B30X/6
04	4	fi-5530C2 Operator's Guide	P3PC-1922-**EN
04	5	fi-5530C2 Getting Started	P3PC-1932-**EN

* xx represents revision number of the manuals.

Convention

Special information, such as warnings, cautions, are indicated as follows:

WARNING

This indication alerts operators to an operation that, if not strictly observed, may result in severe injury or death.

CAUTION

This indication alerts operators to an operation that, if not strictly observed, may result in safety hazards to personnel or damage to equipment.

NOTICE

This indication provides 'how-to' tips or suggestions to help you perform a procedure correctly.

General note:

Be careful not to power off the scanner while communicating with the host computer. In case the scanner is accidentally powered off during communication with the host, follow the procedure below:

1. Power off the host computer
2. Power on the scanner.
3. Power on the host computer.

05	Nov. 20, 2008	K.Okada	T.Anzai	I.Fujioka	Refer to Revision Record on page 2.	TITLE fi-5530C/fi-5530C2 IMAGE SCANNER MAINTENANCE MANUAL	DRAW. No. P1PA03334-B30X/6	CUST.
04	July 7, 2008	K.Okada	T.Anzai	I.Fujioka	Refer to Revision Record on page 2.			
03	Feb.23, 2007	K.Okada	K.Okada	T.Anzai	Refer to Revision Record on page 2.			
Rev	DATE	DESIG.	CHECK	APPR.	DESCRIPTION	PFU LIMITED		PAGE 3/138
DESIG	Aug.19, 2005	K.Okada	CHECK	K.Okada	APPR. T.Anzai			

Trademarks

Microsoft, Windows, and Windows NT are registered trademarks of Microsoft Corporation in the United States and/or other countries.

ISIS, QuickScan and their respective logos are trademarks or registered trademarks of EMC Corporation. 04

Adobe, the Adobe logo, and Acrobat are either registered trademarks of Adobe Systems Incorporated in the United States and/or other countries.

Other product names are the trademarks or registered trademarks of the respective companies.

How Trademarks are Indicated in This Manual

References to operating systems (OS) are indicated as follows:

Windows 95: Microsoft® Windows® 95 operating system.

Windows 98: Microsoft® Windows® 98 operating system.

Windows Me: Microsoft® Windows® Millennium Edition operating system.

Windows NT 4.0: Microsoft® Windows® NT® 4.0 Server operating system,
Microsoft® Windows® NT® 4.0 Workstation operating system

Windows 2000: Microsoft® Windows® 2000 Professional operating system.

Windows XP: Microsoft® Windows® XP Professional operating system,
Microsoft® Windows® XP Home Edition operating system,

04 Microsoft® Windows® XP Professional (32/64-bit)

04

Windows Vista: Microsoft® Windows Vista™ Home Basic operating system (32/64-bit),
Microsoft® Windows Vista™ Home Premium operating system (32/64-bit),
Microsoft® Windows Vista™ Business operating system (32/64-bit),
Microsoft® Windows Vista™ Enterprise operating system (32/64-bit),
Microsoft® Windows Vista™ Ultimate operating system (32/64-bit)

Where there is no distinction between the different versions of the above operating system, the general term “Windows” is used.

Adobe Acrobat: Adobe® Acrobat®

All the descriptions in this manual assume the usage of Adobe Acrobat bundled with this product. However, Adobe Acrobat may be upgraded without notice. If the descriptions differ from the screens actually displayed, refer to the Acrobat’s “Help”.

05	Nov. 20, 2008	K.Okada	T.Anzai	I.Fujioka	Refer to Revision Record on page 2.	TITLE	fi-5530C/fi-5530C2 IMAGE SCANNER MAINTENANCE MANUAL		
04	July 7, 2008	K.Okada	T.Anzai	I.Fujioka	Refer to Revision Record on page 2.				
03	Feb.23, 2007	K.Okada	K.Okada	T.Anzai	Refer to Revision Record on page 2.				
						DRAW. No.	P1PA03334-B30X/6		CUST.
Rev	DATE	DESIG.	CHECK	APPR.	DESCRIPTION	PFU LIMITED		PAGE	4/138
DESIG	Aug.19, 2005	K.Okada	CHECK	K.Okada	APPR.				

Contents

CHAPTER 1 OVERVIEW.....	8
1-1 OVERVIEW	8
1-2 DOCUMENT SPECIFICATION	13
1-2-1 Document Size	13
1-2-2 Document Quality.....	14
1-2-3 Capacity of ADF.....	15
1-2-4 Area not to be perforated.....	16
1-2-5 Multi feed detection condition	17
1-2-6 Condition for automatic document size detection	17
1-3. PARTS CONFIGURATION.....	18
1-4. UNPACKING THE SCANNER	19
1-5. INSTALLING THE SCANNER	20
1-5-1 For safe installation	20
1-5-2 Installation.....	20
1-6 BASIC OPERATION	22
1-6-1 Power ON/OFF.....	22
1-6-2 Loading Documents for Scanning.....	23
1-7 DAILY CARE.....	25
1-7-1 Cleaning ADF.....	25
1-8 REPLACING THE CONSUMABLES.....	28
1-8-1 Consumables.....	28
1-8-2 Replacing Pad ASSY	28
1-8-3 Replacing Pick roller.....	30
1-8-4 Resetting Consumable Counters.....	33
CHAPTER 2 DESCRIPTION OF SCANNER OPERATION.....	34
2-1 ADF UNIT	34
2-2 READING STATION.....	35
2-3 CONTROLLER	36
2-4 ELECTRIC COMPONENT BLOCK DIAGRAM.....	38
CHAPTER 3 TROUBLESHOOTING.....	39
3-1 SELF-DIAGNOSIS FUNCTION.....	39
3-1-1. Scanner status display and self-diagnostics at power-on.....	39
3-1-2. Online self-diagnostics.....	40
3-1-3. Self-diagnostics in Maintenance mode	41
3-2 TEMPORARY ERRORS AND ALARM DETECTION ALGORITHM.....	42
3-2-1. Temporary errors	42
3-2-2. Alarms	45
3-3 TROUBLESHOOTING	48
3-3-1. Scanner does not turn ON (No display on the operator panel).....	49
3-3-2. Scanning does not start	49
3-3-3. Scanned image is distorted	49
3-3-4. Resolution or gradation of scanned image is unsatisfactory	50
3-3-5. Too much jitter on scanned image with ADF scanning.....	51
3-3-6. Scanned image is misaligned with ADF scanning	51
3-3-7. Scan magnification factor abnormal with ADF scanning.....	52
3-3-8. Vertical streaks appear in scanned image	52
3-3-9. When calibrating white of scanned image.....	53
3-3-10. Frequent “U1: paper jam error”.....	53
3-3-11. Error detection of “No paper on the Chute unit”.....	53

05	Nov. 20, 2008	K.Okada	T.Anzai	I.Fujioka	Refer to Revision Record on page 2.	TITLE	fi-5530C/fi-5530C2 IMAGE SCANNER MAINTENANCE MANUAL		
04	July 7, 2008	K.Okada	T.Anzai	I.Fujioka	Refer to Revision Record on page 2.	DRAW. No.	P1PA03334-B30X/6		CUST.
03	Feb.23, 2007	K.Okada	K.Okada	T.Anzai	Refer to Revision Record on page 2.				
Rev	DATE	DESIG.	CHECK	APPR.	DESCRIPTION	PFU LIMITED		PAGE	5/138
DESIG	Aug.19, 2005	K.Okada	CHECK	K.Okada	APPR. T.Anzai				

3-3-12. Error detection of “U4: ADF cover open”54
 3-3-13. Frequent “U2: multi feed error”54
 3-3-14. “E2 or E3: Optical alarm”55
 3-3-15. “E4: Motor fuse blown”56
 3-3-16. (Reserved)57
 3-3-17. “E6: Operator panel alarm”57
 3-3-18. “E7: EEPROM alarm”57
 3-3-19. “E8: SCSI fuse blown”57
 3-3-20. “E9: Image memory alarm”58
 3-3-21. “EA: Imprinter error”58
 3-3-22. “Ec: RAM alarm”58
 3-3-23. “Ed: SPC alarm”58
 3-3-24. “EF: Background changeover alarm”59

CHAPTER 4 DISASSEMBLY / ASSEMBLY 60

4-1. SAFETY 60
 4-2. MAINTENANCE 61
 4-2-1 Periodic maintenance 61
 4-3 CLEANING 62
 4-3-1 Cleaning Optical unit (for front side) 62
 4-3-2 Cleaning glass of Dust Cover 62
 4-3-3 Cleaning Optical unit (for backside) 62
 4-3-4 Cleaning glass of Upper Frame ASSY 62
 4-4 MAINTENANCE TOOL 63
 4-5 NON DISASSEMBLY PARTS 64
 4-6 (RESERVED) 64
 4-7. REMOVING / MOUNTING CHUTE UNIT, STACKER UNIT, PCB UNIT AND COVERS 65
 4-7-1. Removing/Mounting the Chute unit (ADF paper chute) 65
 4-7-2. Removing/Mounting the Stacker Unit 65
 4-7-3. Removing/Mounting the PCB unit 66
 4-7-4. Removing/Mounting the Rear cover 67
 4-7-5. Removing/Mounting the Upper cover 68
 4-7-6. Removing/Mounting the Guide A ASSY 70
 4-8. REPLACING THE UPPER UNIT AND THE BASE UNIT 71
 4-9. REPLACING THE PARTS IN THE UPPER UNIT 73
 4-9-1. Replacing the Panel PCA 73
 4-9-2. Replacing the Inverter SR 74
 4-9-3. Replacing the Optical unit, OPT unit with cable B and CCD Cable B 75
 4-9-4. Replacing the Lamp SR (for ADF backside) 77
 4-9-5. Replacing the US Sensor (In Upper unit) 78
 4-9-6. Replacing the LF Motor 79
 4-9-7. Replacing Sensor EM / Sensor PICK / Sensor TOP 80
 4-9-8. Replacing the Upper Frame ASSY 82
 4-10. REPLACING THE PARTS IN THE BASE UNIT 83
 4-10-1 Replacing the Guide P ASSY (sheet guide), US Sensor, US PCA 83
 4-10-2. Replacing the HK Ring SR 84
 4-10-3. Replacing the Dust cover 85
 4-10-4. Replacing the Inverter SR (for front side scanning) 87
 4-10-5. Replacing the Lamp SR (for ADF front) 88
 4-10-6. Replacing the Optical Unit, OPT unit with Cable F, CCD Cable F 89
 4-10-7. Replacing the Pick Motor 90
 4-10-8. Replacing the BW Motor 91
 4-11. REPLACING THE CONTROL PCA 92

CHAPTER 5 ADJUSTMENT/SETTINGS 93

5-1 MAINTENANCE MODE 93

05	Nov. 20, 2008	K.Okada	T.Anzai	I.Fujioka	Refer to Revision Record on page 2.	TITLE fi-5530C/fi-5530C2 IMAGE SCANNER MAINTENANCE MANUAL	DRAW. No. P1PA03334-B30X/6	CUST.
04	July 7, 2008	K.Okada	T.Anzai	I.Fujioka	Refer to Revision Record on page 2.			
03	Feb.23, 2007	K.Okada	K.Okada	T.Anzai	Refer to Revision Record on page 2.			
Rev	DATE	DESIG.	CHECK	APPR.	DESCRIPTION	PFU LIMITED		PAGE
DESIG	Aug.19, 2005	K.Okada	CHECK	K.Okada	APPR. T.Anzai			6/138

5-1-1 Activating the Maintenance mode..... 93
 5-1-2 Maintenance mode #1: Paper feeding test / Sensor test / Background changeover test..... 95
 5-1-3 Maintenance mode #2: Main scanning / Sub-scanning magnification adjustment 97
 5-1-4 Maintenance mode #3 : Offset adjustment..... 101
 5-1-5 Maintenance mode #4: White level adjustment..... 104
 5-1-6 Maintenance mode #5: Counter display and reset..... 107
 5-1-7 Maintenance mode #6: Miscellaneous information display..... 109
 5-1-8 Maintenance mode #7: EEPROM data restore 111
 5-2 SAVING EEPROM DATA 112
 5-3 EMULATION MODE..... 113

CHAPTER 6 MAINTENANCE PARTS 116

6-1. BASE UNIT 117
 6-2. DUST COVER 117
 6-3. HK RING SR..... 118
 6-4. INVERTER SR..... 118
 6-5. LAMP SR..... 119
 6-6. US SENSOR..... 119
 6-7. US PCA 120
 6-8. OPTICAL UNIT WITH CABLE F 120
 6-9. CCD CABLE F..... 121
 6-10. OPTICAL UNIT 121
 6-11. PICK MOTOR..... 122
 6-12. GUIDE P ASSY 122
 6-13. BW MOTOR..... 123
 6-14. UPPER UNIT 123
 6-15. UPPER FRAME ASSY..... 124
 6-16. LF MOTOR 124
 6-17. SENSOR EM..... 125
 6-18. SENSOR PICK 125
 6-19. SENSOR TOP 126
 6-20. OPTICAL UNIT WITH CABLE B 126
 6-21. CCD CABLE B 127
 6-22. PANEL PCA 127
 6-23. CONTROL PCA..... 128
 6-24. STACKER UNIT..... 128
 6-25. CHUTE UNIT 129
 6-26. AC ADAPTER..... 129
 6-27. AC CORDSET U..... 130
 6-28. AC CORDSET E / AC CORDSET C / AC CORDSET UK 130

APPENDIX A DEFINITION OF SCANNER AND CAMERA PROPERTIES 131

A.1 DISPLAYING SCANNER AND CAMERA PROPERTIES..... 131
 A.2 GENERAL TAB 131
 A.3 EVENTS TAB 132
 A.4 DIAGNOSTIC TAB 133
 A.5 DEVICE INFORMATION TAB..... 134
 A.6 DEVICE SETUP TAB 135
 A.7 ABOUT TAB 138
 A.8 COLOR MANAGEMENT TAB FOLDER..... 138

05	Nov. 20, 2008	K.Okada	T.Anzai	I.Fujioka	Refer to Revision Record on page 2.	TITLE fi-5530C/fi-5530C2 IMAGE SCANNER MAINTENANCE MANUAL	DRAW. No. P1PA03334-B30X/6	CUST.
04	July 7, 2008	K.Okada	T.Anzai	I.Fujioka	Refer to Revision Record on page 2.			
03	Feb.23, 2007	K.Okada	K.Okada	T.Anzai	Refer to Revision Record on page 2.			
Rev	DATE	DESIG.	CHECK	APPR.	DESCRIPTION	PFU LIMITED		PAGE
DESIG	Aug.19, 2005	K.Okada	CHECK	K.Okada	APPR. T.Anzai			7/138

Chapter 1 OVERVIEW

1-1 Overview

This scanner offers high-speed color/monochrome scanning with 600 dpi of optical resolution, up to A3 or 11x17 size. It supports two interfaces, SCSI interface and USB interface, either of which can be used at a time.

<Scanner Specifications>

No.	Items	Specifications	
		fi-5530C	fi-5530C2 03
1	Scanner type	Automatic Document Feeder (ADF)	
2	Scanning speed	Binary (Monochrome) Simplex: 35 ppm / Duplex: 70 ipm (@200 dpi, A4, 80g/m ² or 20lb, Portrait) Color Simplex: 45 ppm / Duplex: 90 ipm (@150 dpi, A4, 80g/m ² or 20lb, Portrait)	
3	Optical resolution	600 x 600 dpi	
4	Output resolution	Monochrome: 50 – 600dpi Gray: 50 – 600 dpi Color: 50 – 600 dpi	
5	Bit depth	Color 24bit, Gray 8bit, Monochrome 1bit	
6	Document (ADF scanning)	Size: Max. A3 or 11 x 17 Min. A8 Portrait (53 x 74 mm) Thickness: 52 to 127 g/m ² (14 to 34 lb)	
7	Capacity of hopper	100 sheets (A4, 80g/m ² or 20lb) 50 sheets (A4, 80g/m ² or 20lb)	
8	Optical system	Minification optical system	
9	Light source	Incandescent cold cathode fluorescent lamp x2	
10	Interface	Ultra SCSI (Shield-type 50 pin (pin type) halfpitch) x1 USB 2.0 x1 (USB 1.1 compatible, although scanning speed is slower.)	
11	Attached driver	TWAIN, ISIS	
12	Operator panel	Button: Scan, Send To, Function, Power Lamp: Power (LED), Scanner status (Function No. Display)	
13	Options	Imaging Processing Software fi-553PR Imprinter	

<Environmental Specifications>

No.	Items	Specifications	
		fi-5530C	fi-5530C2 03
1	Input power	Voltage	100 to 120VAC ± 10%, 220 to 240VAC ± 10%
		Phases	Single-phase
		Frequency	50/60 ± 3Hz
2	Power consumption	Operating: 57W (Rated power) Energy-saving: 12W Not operating: 35W	Operating: 57W (Rated power) Energy-saving: 7.5W or less Not operating: 35W
3	Noise	50 dB or less	
4	Outer dimensions	Excluding Chute and Stacker Unit: 399 (W) x 225 (D) x 193 (H) mm / 15.7 (W) x 8.9 (D) x 7.6 (H) in	
5	Weight	8.5 kg or less (18.7 lb or less)	
6	Ambient condition	Temperature	Operating: 5 to 35 °C (41 to 95°F) Not using: -20 to 60 °C (-4 to 140°F)
		Humidity	Operating: 20 to 80 % Not using: 8 to 95 %

05	Nov. 20, 2008	K.Okada	T.Anzai	I.Fujioka	Refer to Revision Record on page 2.	TITLE fi-5530C/fi-5530C2 IMAGE SCANNER MAINTENANCE MANUAL	DRAW. No. P1PA03334-B30X/6	CUST.
04	July 7, 2008	K.Okada	T.Anzai	I.Fujioka	Refer to Revision Record on page 2.			
03	Feb. 23, 2007	K.Okada	K.Okada	T.Anzai	Refer to Revision Record on page 2.			
Rev	DATE	DESIG.	CHECK	APPR.	DESCRIPTION	PFU LIMITED	PAGE	8/138
DESIG	Aug. 19, 2005	K.Okada	CHECK	K.Okada	APPR. T.Anzai			

<Appearance>

[Front]

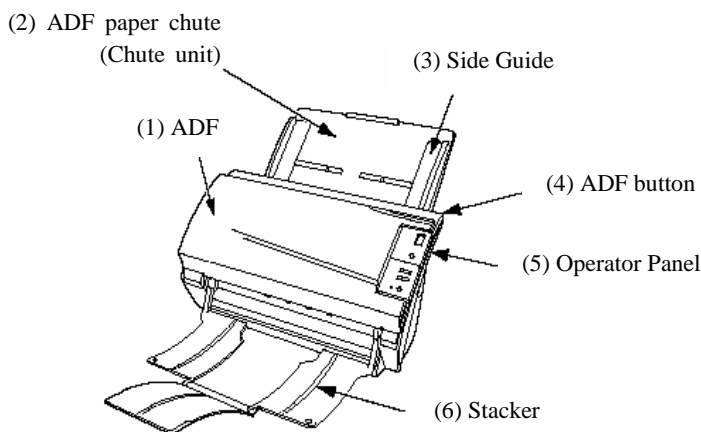

No.	Parts name	Function
1	ADF (Automatic Document Feeder)	Automatically feeds documents into the scanner
2	ADF paper chute (Chute unit)	Used when scanning documents on the ADF
3	Side Guide	Adjust the side guides to match the width of the documents to prevent the document from skewing.
4	ADF button	Press this button to open the ADF cover, for example, to remove jammed documents in the ADF.
5	Operator panel	Used for operating the scanner. The scanner status is indicated on the Function No. Display Panel.
6	Stacker	Documents are stacked here after they are scanned.

[Back]

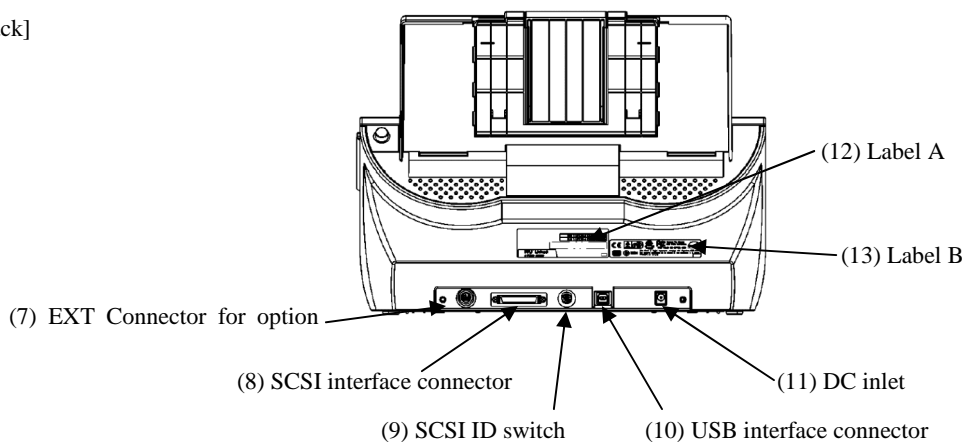

No.	Parts name	Function
7	EXT Connector for option	Connects the cable from option.
8	SCSI interface connector	Connects the SCSI interface cable from the host PC or Computer here. *
9	SCSI ID switch	Sets the SCSI-ID. (Set to "5" before the scanner is shipped from the factory.)
10	USB interface connector	Connects the USB interface cable from the host PC or Computer here. *
11	DC inlet	Connects the AC adapter here.
12	Label A	Indicates scanner information.
13	Label B	Indicates various standards that the scanner conforms with.

* Either SCSI or USB interface connector shall be connected. Only one interface is active at a time.

05	Nov. 20, 2008	K.Okada	T.Anzai	I.Fujioka	Refer to Revision Record on page 2.	TITLE	fi-5530C/fi-5530C2 IMAGE SCANNER MAINTENANCE MANUAL		
04	July 7, 2008	K.Okada	T.Anzai	I.Fujioka	Refer to Revision Record on page 2.				
03	Feb. 23, 2007	K.Okada	K.Okada	T.Anzai	Refer to Revision Record on page 2.				
						DRAW. No.	P1PA03334-B30X/6		CUST.
Rev	DATE	DESIG.	CHECK	APPR.	DESCRIPTION	PFU LIMITED		PAGE	9/138
DESIG	Aug.19, 2005	K.Okada	CHECK	K.Okada	APPR.				

Label A (Manufacturing label) (example)

fi-5530C

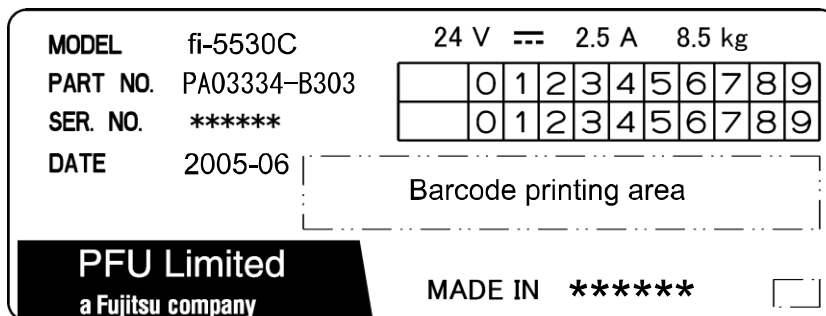

fi-5530C2 03

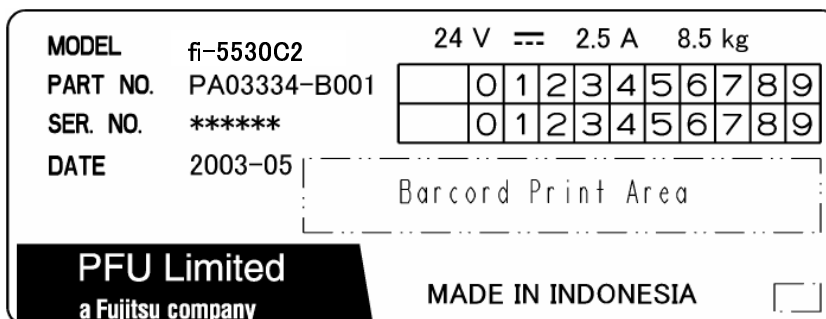

Label B (Authorize label) (example)

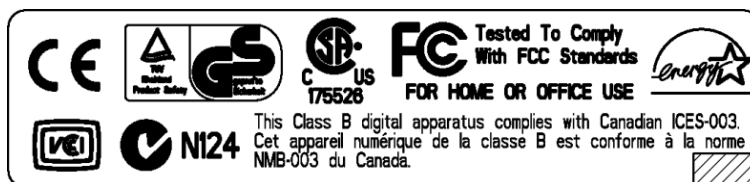

05	Nov. 20, 2008	K.Okada	T.Anzai	I.Fujioka	Refer to Revision Record on page 2.	TITLE fi-5530C/fi-5530C2 IMAGE SCANNER MAINTENANCE MANUAL	DRAW. No.	CUST.
04	July 7, 2008	K.Okada	T.Anzai	I.Fujioka	Refer to Revision Record on page 2.			
03	Feb.23, 2007	K.Okada	K.Okada	T.Anzai	Refer to Revision Record on page 2.			
Rev	DATE	DESIG.	CHECK	APPR.	DESCRIPTION	PFU LIMITED	PAGE	10/138
DESIG	Aug.19, 2005	K.Okada	CHECK	K.Okada	APPR. T.Anzai			

[Operator Panel]

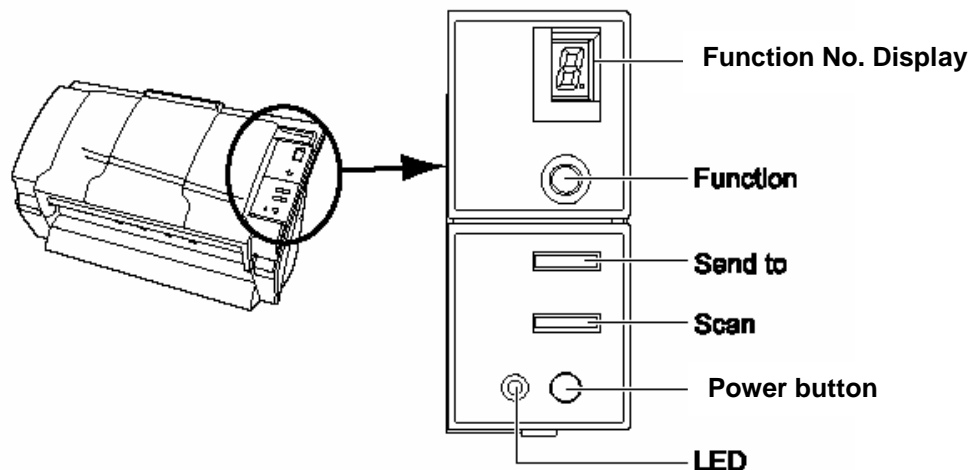

Name		Function
Function No. Display		Indicates the function No, Scan mode and Error status.
Button	Function	Changes the Function activated by the Send to button (*).
	Send to	Launches the linked application software (*).
	Scan	
	Power button	Turns the scanner ON and OFF
LED	-	Lights when the scanner is turned ON.

(*): About the settings on the launcher, refer to FUJITSU TWAIN 32 scanner driver help on the Setup CD-ROM.

[Paper thickness switch]

The scanner has a switch near the Pad ASSY to set the thickness of document to be scanned. Set this switch "Normal", if document thickness is 52 g/m² (13.9 lb) or thicker (nonstandard), otherwise Miss-pick may occur. This switch can be set "Thin" only when the document is thinner than 52 g/m². However this does not mean that the scanning of thin paper less than 52 g/m² is assured.

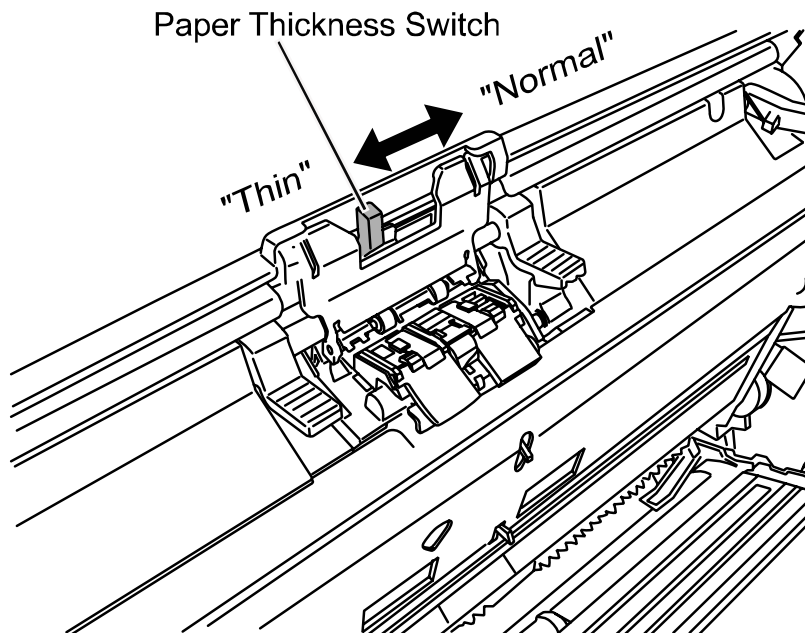

05	Nov. 20, 2008	K.Okada	T.Anzai	I.Fujioka	Refer to Revision Record on page 2.	TITLE	fi-5530C/fi-5530C2 IMAGE SCANNER MAINTENANCE MANUAL		
04	July 7, 2008	K.Okada	T.Anzai	I.Fujioka	Refer to Revision Record on page 2.				
03	Feb.23, 2007	K.Okada	K.Okada	T.Anzai	Refer to Revision Record on page 2.				
						DRAW. No.	P1PA03334-B30X/6		CUST.
Rev	DATE	DESIG.	CHECK	APPR.	DESCRIPTION	PFU LIMITED		PAGE	11/138
DESIG	Aug.19, 2005	K.Okada	CHECK	K.Okada	APPR. T.Anzai				

[Outer dimensions]

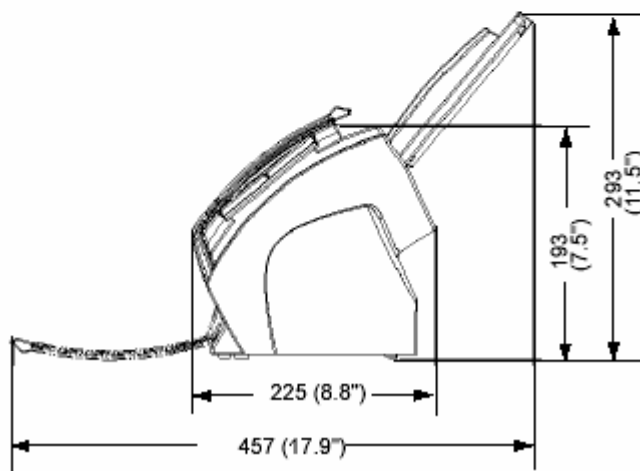
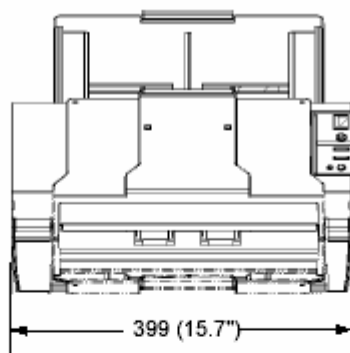

05	Nov. 20, 2008	K.Okada	T.Anzai	I.Fujioka	Refer to Revision Record on page 2.	TITLE	fi-5530C/fi-5530C2 IMAGE SCANNER MAINTENANCE MANUAL		
04	July 7, 2008	K.Okada	T.Anzai	I.Fujioka	Refer to Revision Record on page 2.				
03	Feb.23, 2007	K.Okada	K.Okada	T.Anzai	Refer to Revision Record on page 2.				
						DRAW. No.	P1PA03334-B30X/6		CUST.
Rev	DATE	DESIG.	CHECK	APPR.	DESCRIPTION	PFU LIMITED		PAGE	12/138
DESIG	Aug.19, 2005	K.Okada	CHECK	K.Okada	APPR. T.Anzai				

1-2 Document specification

Following is the document specification of this scanner

1-2-1 Document Size

Following size of document is available.

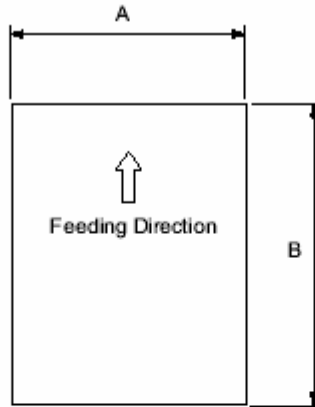

Maximum		Minimum	
A	B	A	B
297 (11.7 in)	863.6 (34 in)	51 (2.0 in)	74 (2.9 in)

(Unit : mm)

05	Nov. 20, 2008	K.Okada	T.Anzai	I.Fujioka	Refer to Revision Record on page 2.	TITLE fi-5530C/fi-5530C2 IMAGE SCANNER MAINTENANCE MANUAL	DRAW. No. P1PA03334-B30X/6	CUST.
04	July 7, 2008	K.Okada	T.Anzai	I.Fujioka	Refer to Revision Record on page 2.			
03	Feb.23, 2007	K.Okada	K.Okada	T.Anzai	Refer to Revision Record on page 2.			
Rev	DATE	DESIG.	CHECK	APPR.	DESCRIPTION	PFU LIMITED	PAGE	13/138
DESIG	Aug.19, 2005	K.Okada	CHECK	K.Okada	APPR. T.Anzai			

1-2-2 Document Quality

This section describes the type and thickness of documents that can be loaded on the scanner and precautions.

- Recommended Document Type

- Woodfree paper
- Wood containing paper

When scanning the paper with the document type other than the above, perform a test-scanning with a few sheets of the same type before executing the actual task in order to check whether or not the document can be scanned.

- Document Thickness

Paper thickness is expressed by the unit of “paper weight”. The following shows the paper thickness that can be scanned by this scanner.

52 g/m² to 127 g/m²

Only a paper weight of 127 g/m² is allowed for A8-size documents.

- Precautions

The following documents may not be scanned successfully.

- Documents of non-uniform thickness (e.g. envelopes)
- Wrinkled or curled documents (See right figure)
- Folded or torn documents
- Tracing paper
- Coated paper
- Carbon paper
- Carbonless paper
- Photosensitive paper
- Perforated or punched documents
- Documents that are not square or rectangular
- Very thin documents

Do not use the following documents:

- Paper-clipped or stapled documents
- Documents on which the ink is still wet
- Documents smaller than A8 (Portrait) in size
- Documents wider than A3 or 11 x 17 in size
- Documents other than paper such as fabric, metal foil or transparencies

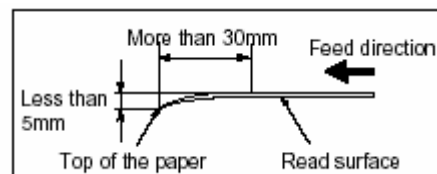
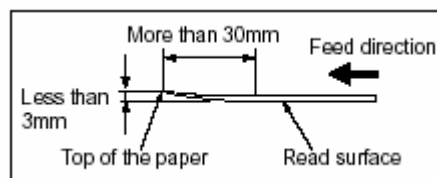

- Note: - When scanning semi-transparent documents, slide the [Brightness] bar to light to avoid bleed through.
- To prevent the rollers from becoming dirty, avoid scanning documents containing large areas written or filled in pencil. If scanning of such document is inevitable, clean the rollers more frequently.

Note: - Carbonless paper contains chemical substances that may harm the Pad ASSY or rollers (e.g. Pick roller) when documents are fed. Pay attention to the following:

Cleaning: If document jams occur frequently, clean the Pad ASSY and the Pick roller, by referring [Section 1-7-1](#).

Replacement parts: The service life of the Pad ASSY and the Pick roller may be shortened compared to the case of scanning wood containing paper documents.

- When scanning wood containing paper, the life of the Pad ASSY and the Pick roller may be shortened compared to the case of scanning woodfree paper.

05	Nov. 20, 2008	K.Okada	T.Anzai	I.Fujioka	Refer to Revision Record on page 2.	TITLE fi-5530C/fi-5530C2 IMAGE SCANNER MAINTENANCE MANUAL	DRAW. No. P1PA03334-B30X/6	CUST.
04	July 7, 2008	K.Okada	T.Anzai	I.Fujioka	Refer to Revision Record on page 2.			
03	Feb.23, 2007	K.Okada	K.Okada	T.Anzai	Refer to Revision Record on page 2.			
Rev	DATE	DESIG.	CHECK	APPR.	DESCRIPTION	PFU LIMITED		PAGE
DESIG	Aug.19, 2005	K.Okada	CHECK	K.Okada	APPR. T.Anzai			14/138

1-2-3 Capacity of ADF

The maximum number of sheets that can be loaded on the ADF (Capacity of ADF) changes depending on the size and paper weight of the documents. The following graph shows the capacity of ADF with respect to paper weight.

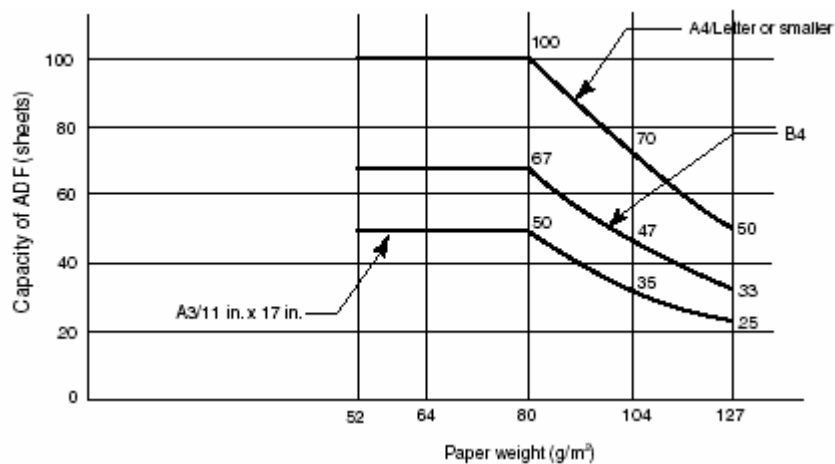

Paper weight conversion table

Unit	Conversion						
g/m ²	52	64	75	80	90	104	127
lb	13.9	17.0	20.0	21	24.0	27.9	34.0

05	Nov. 20, 2008	K.Okada	T.Anzai	I.Fujioka	Refer to Revision Record on page 2.	TITLE fi-5530C/fi-5530C2 IMAGE SCANNER MAINTENANCE MANUAL	DRAW. No. P1PA03334-B30X/6	CUST.
04	July 7, 2008	K.Okada	T.Anzai	I.Fujioka	Refer to Revision Record on page 2.			
03	Feb.23, 2007	K.Okada	K.Okada	T.Anzai	Refer to Revision Record on page 2.			
Rev	DATE	DESIG.	CHECK	APPR.	DESCRIPTION	PFU LIMITED	PAGE	15/138
DESIG	Aug.19, 2005	K.Okada	CHECK	K.Okada	APPR. T.Anzai			

1-2-4 Area not to be perforated

Feeding trouble of the document might occur, if there is any punched hole in the shaded area in the following figure.

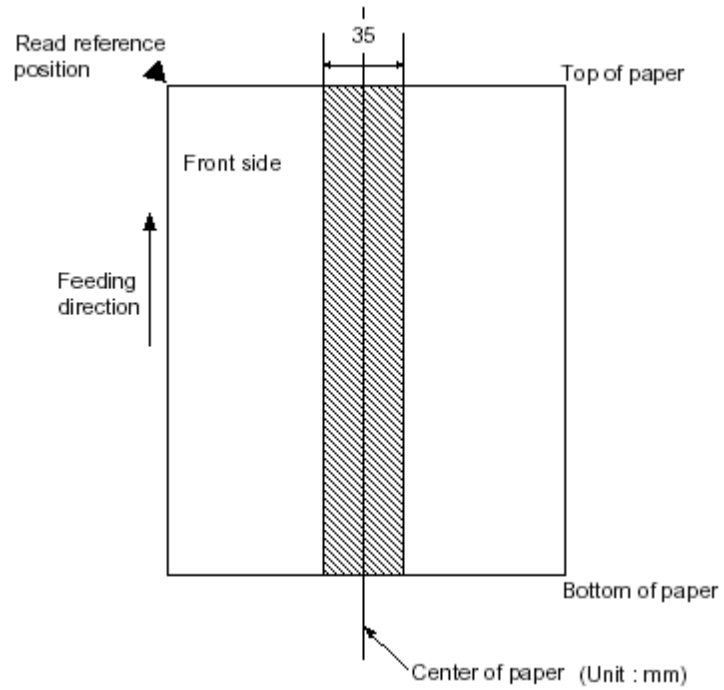

05	Nov. 20, 2008	K.Okada	T.Anzai	I.Fujioka	Refer to Revision Record on page 2.	TITLE fi-5530C/fi-5530C2 IMAGE SCANNER MAINTENANCE MANUAL	DRAW. No. P1PA03334-B30X/6	CUST.
04	July 7, 2008	K.Okada	T.Anzai	I.Fujioka	Refer to Revision Record on page 2.			
03	Feb.23, 2007	K.Okada	K.Okada	T.Anzai	Refer to Revision Record on page 2.			
Rev	DATE	DESIG.	CHECK	APPR.	DESCRIPTION	PFU LIMITED	PAGE	16/138
DESIG	Aug.19, 2005	K.Okada	CHECK	K.Okada	APPR. T.Anzai			

1-2-5 Multi feed detection condition

One of the following method of multi feed detection is selected by the driver.

- Check overlapping
- Check length
- Check overlapping and length

The following condition is required for each selection:

1) Check overlapping

- Paper weight: 52g/m² - 127g/m²
- Punched holes are not allowed within 35 mm (1.4 in) of the vertical centerline of the document.
- Other paper shall not be glued within 35 mm (1.4 in) of the vertical centerline of the document.

2) Check length

- Document length deviation: 1 % or less
- Punched holes are not allowed within 35 mm (1.4 in) of the vertical centerline of the document.

3) Check overlapping and length

- Paper weight: 52g/m² - 127g/m²
- Document length deviation: 1 % or less
- Punched holes are not allowed within 35 mm (1.4 in) of the vertical centerline of the document.
- Other paper shall not be glued within 35 mm (1.4 in) of the vertical centerline of the document.

When the overlapping check is specified, the papers which contact closely each other, such as glued paper or electro-statically charged paper, can result in the miss-detection of multi feed.

1-2-6 Condition for automatic document size detection

Document with following condition may not be detected its size correctly.

- Thin paper less than 52g/m²
- Shape is other than square
- Document which edges are colored dark.

05	Nov. 20, 2008	K.Okada	T.Anzai	I.Fujioka	Refer to Revision Record on page 2.	TITLE	fi-5530C/fi-5530C2 IMAGE SCANNER MAINTENANCE MANUAL		
04	July 7, 2008	K.Okada	T.Anzai	I.Fujioka	Refer to Revision Record on page 2.				
03	Feb.23, 2007	K.Okada	K.Okada	T.Anzai	Refer to Revision Record on page 2.				
						DRAW. No.	P1PA03334-B30X/6	CUST.	
Rev	DATE	DESIG.	CHECK	APPR.	DESCRIPTION	PFU LIMITED		PAGE	17/138
DESIG	Aug.19, 2005	K.Okada	CHECK	K.Okada	APPR. T.Anzai				

1-3. Parts Configuration

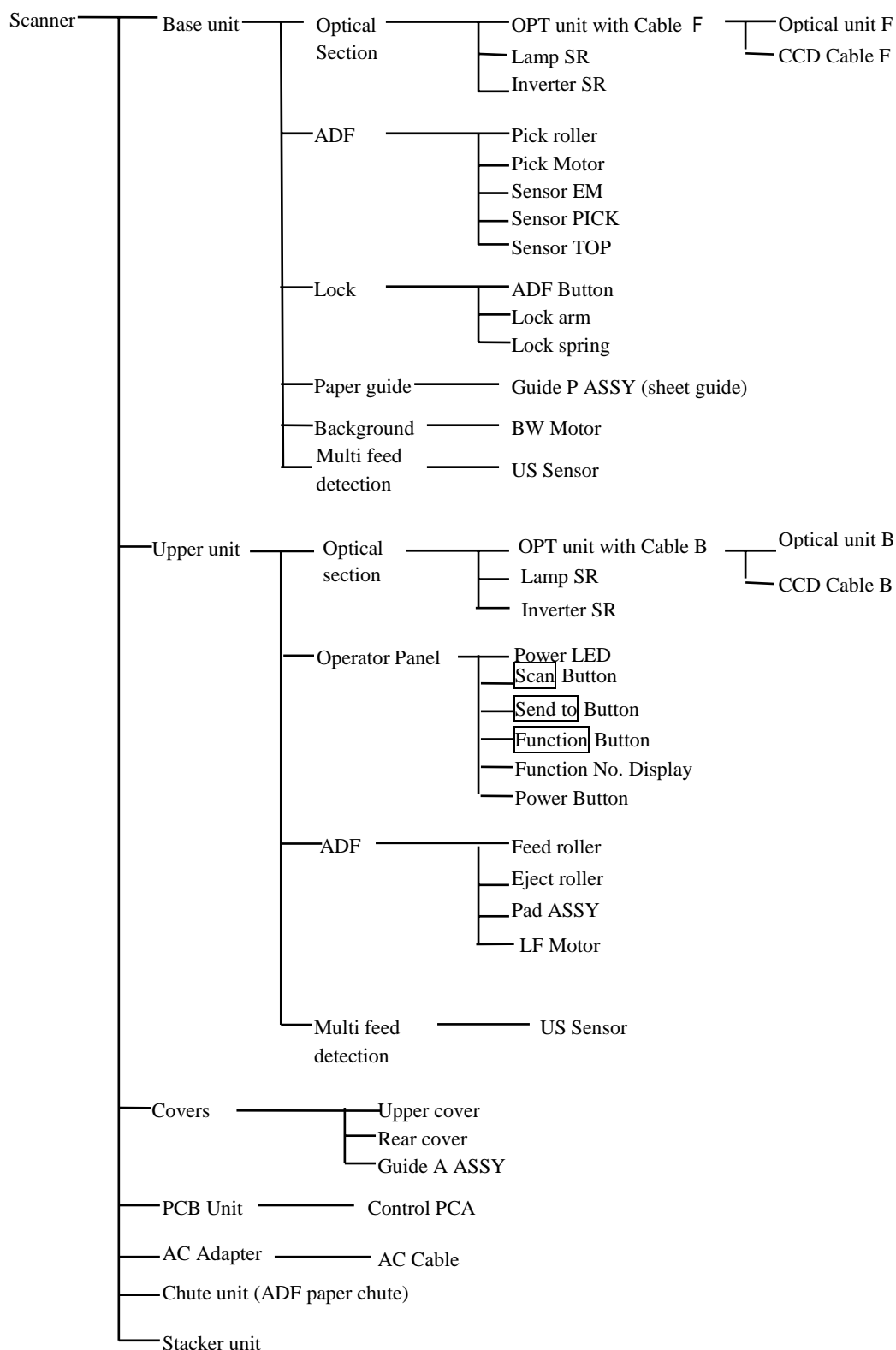

05	Nov. 20, 2008	K.Okada	T.Anzai	I.Fujioka	Refer to Revision Record on page 2.	TITLE	fi-5530C/fi-5530C2 IMAGE SCANNER MAINTENANCE MANUAL		
04	July 7, 2008	K.Okada	T.Anzai	I.Fujioka	Refer to Revision Record on page 2.	DRAW. No.	P1PA03334-B30X/6		CUST.
03	Feb.23, 2007	K.Okada	K.Okada	T.Anzai	Refer to Revision Record on page 2.				
Rev	DATE	DESIG.	CHECK	APPR.	DESCRIPTION	PFU LIMITED		PAGE	18/138
DESIG	Aug.19, 2005	K.Okada	CHECK	K.Okada	APPR. T.Anzai				

1-4. Unpacking the scanner

Follow the procedure below to unpack the scanner package. Make sure that all the accessories are included in the package.

1. Remove the tape to open the package box.
2. Take out the CD tray and other accessories.
3. Take out the scanner and cushions. And remove the cushioning materials.
4. Open the polyethylene bag to take out the scanner.
5. Take out all the accessories and remove the tape protecting the scanner.

The following table lists the packaging configuration.

No.	Items	Quantity
1	Outer box	1
2	CD tray (including accessories)	1
3	Cushion T	1
4	Cushion B	1
5	Scanner in Polyethylene bag	1
6	ADF paper chute (Chute unit)	1

Table 1-4 Packaging configurations

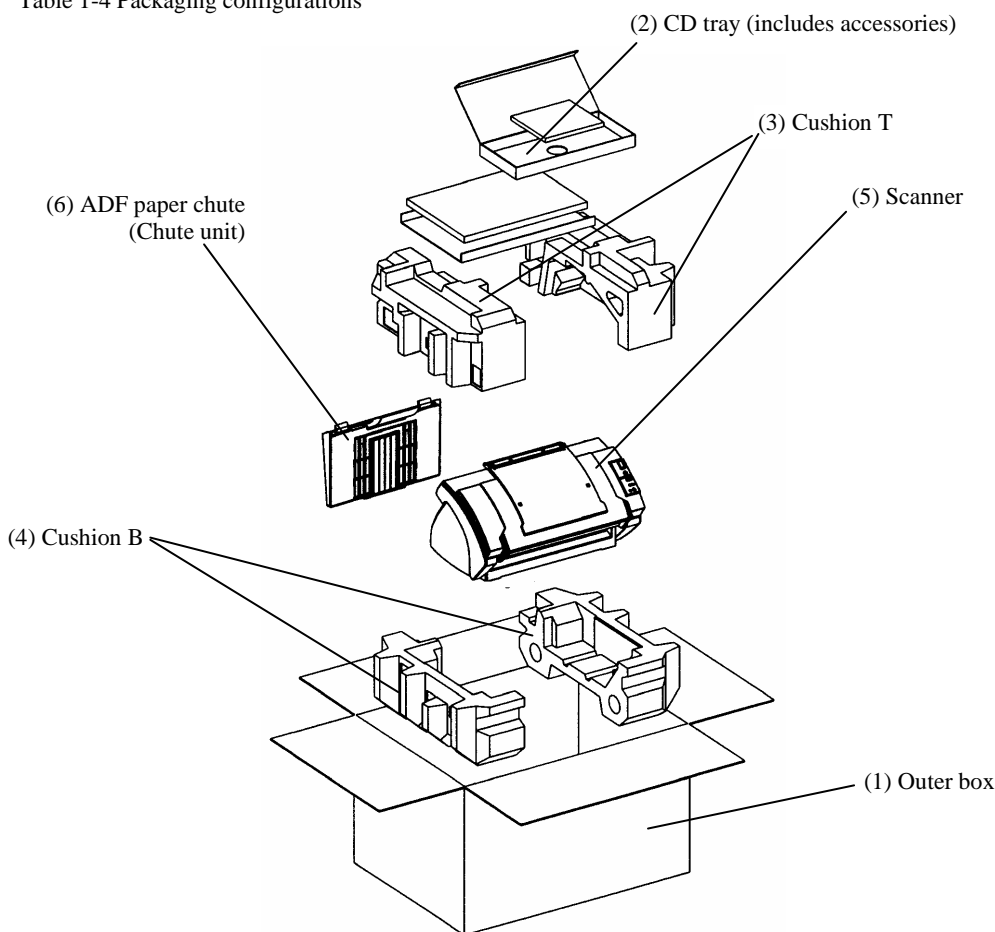

Figure 1-4

05	Nov. 20, 2008	K.Okada	T.Anzai	I.Fujioka	Refer to Revision Record on page 2.	TITLE	fi-5530C/fi-5530C2 IMAGE SCANNER MAINTENANCE MANUAL		
04	July 7, 2008	K.Okada	T.Anzai	I.Fujioka	Refer to Revision Record on page 2.	DRAW. No.	P1PA03334-B30X/6	CUST.	
03	Feb.23, 2007	K.Okada	K.Okada	T.Anzai	Refer to Revision Record on page 2.				
Rev	DATE	DESIG.	CHECK	APPR.	DESCRIPTION	PFU LIMITED	PAGE	19/138	
DESIG	Aug.19, 2005	K.Okada	CHECK	K.Okada	APPR. T.Anzai				

1-5. Installing the scanner

1-5-1 For safe installation

Before installing the scanner, read the following cautions carefully to avoid scanner trouble.
Refer to [Section 1-1](#) "Overview" for information of power source and scanner dimensions.

- Install the scanner away from strong magnetic fields and other sources of noise.
- Do not install the scanner near heating apparatus or in the direct sunlight.
- Install the scanner in a location which is level and subject to minimal vibration. Make sure the rubber pads on the bottom of the scanner grounds evenly.
- Do not install the scanner in locations subject to humidity and dust.
- Do not block the ventilation ports.
- Protect the scanner from static electricity.
- Use proper AC voltage.

1-5-2 Installation

- (1) Place the scanner at its installation site.
For details on the scanner's dimensions and required installation space, refer to "Environmental specifications" in [Section 1-1 "Overview"](#).
- (2) Attach the ADF paper chute (Chute unit) by referring to [Section 4-7-1](#).

- (3) Connect the AC adapter.

Use only the AC adapter provided by the manufacturer.

- 1) Connect the AC cable to the AC adapter.
- 2) Connect the AC adapter connector to the Scanner's DC inlet.
- 3) Plug the AC cable into the outlet.

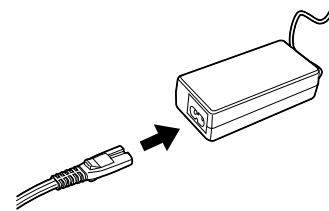

Note: The function Number Display and the LED may flash for an instant when plugging the AC cable into the outlet.

- (4) Connect the USB interface cable or the SCSI cable to the interface connector of the scanner. Then connect the other end of the interface cable to the PC.

Note 1: This scanner is provided with two interfaces: Ultra SCSI and USB 2.0/1.1. Connect only one of the USB or SCSI interface cable.

- When running Windows 95 or Windows NT 4.0, connect the scanner with the SCSI interface cable. These operating systems do not support USB interface.
- When running Windows 98, Windows Me, Windows 2000, or Windows XP, connect the scanner to the PC by either the USB interface cable or the SCSI cable.

Note 2: Be sure to use the USB cable which comes as an accessory with this scanner. Correct operation with commercially available cables is not guaranteed.

Note 3: When connecting to a USB hub, use the first stage USB hub that is closest to the computer. If you use the second or later hub stages, the scanner may not operate correctly.

Note 4: If you connect the scanner with USB 2.0, it is required that the USB port and Hub are compliant with USB 2.0. The scanning speed may slow down if it is connected with USB 1.0.

05	Nov. 20, 2008	K.Okada	T.Anzai	I.Fujioka	Refer to Revision Record on page 2.	TITLE	fi-5530C/fi-5530C2 IMAGE SCANNER MAINTENANCE MANUAL		
04	July 7, 2008	K.Okada	T.Anzai	I.Fujioka	Refer to Revision Record on page 2.	DRAW. No.	P1PA03334-B30X/6		CUST.
03	Feb.23, 2007	K.Okada	K.Okada	T.Anzai	Refer to Revision Record on page 2.				
Rev	DATE	DESIG.	CHECK	APPR.	DESCRIPTION	PFU LIMITED		PAGE	20/138
DESIG	Aug.19, 2005	K.Okada	CHECK	K.Okada	APPR.			T.Anzai	

Note 5: When using the scanner with a SCSI interface, the following SCSI interface cable and SCSI card must be purchased.

- SCSI interface cable:

Use a cable which complies with a 50 Pin Contact Shielded High-Density SCSI Device Connector for Ultra SCSI.

- SCSI card:

Find the recommended SCSI card information in Fujitsu web site (FAQ).

<http://imagescanner.fujitsu.com/>

- When connecting the SCSI interface cable, turn the scanner off. Be sure to connect the SCSI interface cable first, and then turn on the power of the scanner and PC.
- In a SCSI daisy chain formation, connect the scanner so that it is the terminated device.
- Be careful not to bend the pins of the SCSI cable when connecting to the scanner.

(5) SCSI ID initially set at the factory is "5". If the SCSI ID of another SCSI device is to the same ID, either change the scanner's SCSI ID or SCSI ID of the other SCSI device.

- 1) Press the Power button at least two seconds to turn OFF the scanner when it is ON.
- 2) Set the SCSI ID by using the SCSI ID switch on the back of the scanner.

ID No.	Description
0 to 7	Can be set as the ID
8, 9	Works with the factory default value (SCSI ID = 5)



- 3) Press the power button to turn ON the scanner.
When the scanner is turned ON, the SCSI ID set at step 2 is enabled.

(6) Install the software.

For scanning documents with this scanner, both scanner driver and image capturing software (application) must be installed on the PC. The following scanner drivers and applications are provided:

Scanner driver:

- FUJITSU TWAIN 32 Scanner Driver
- FUJITSU ISIS Scanner Driver

Scanning application:

- ScandAll 21 (for FUJITSU TWAIN 32)
- QuickScan Pro™ (for FUJITSU ISIS)

Install the appropriate scanner driver for the application you will use.

05	Nov. 20, 2008	K.Okada	T.Anzai	I.Fujioka	Refer to Revision Record on page 2.	TITLE fi-5530C/fi-5530C2 IMAGE SCANNER MAINTENANCE MANUAL	DRAW. No. P1PA03334-B30X/6	CUST.
04	July 7, 2008	K.Okada	T.Anzai	I.Fujioka	Refer to Revision Record on page 2.			
03	Feb. 23, 2007	K.Okada	T.Anzai	I.Fujioka	Refer to Revision Record on page 2.			
Rev	DATE	DESIG.	CHECK	APPR.	DESCRIPTION	PFU LIMITED		PAGE 21/138
DESIG	Aug. 19, 2005	K.Okada	CHECK	K.Okada	APPR. T.Anzai			

1-6 Basic Operation

1-6-1 Power ON/OFF

(1) Turning ON the power

Press the power button on the operator panel.

The scanner is turned ON, and the green LED on the operator panel lights.

During the initialization, the indication of the Function No. Display changes as follows:

“8” → “P” → “0” → “1”

The indication “1” means that the operator panel is in the ready status.

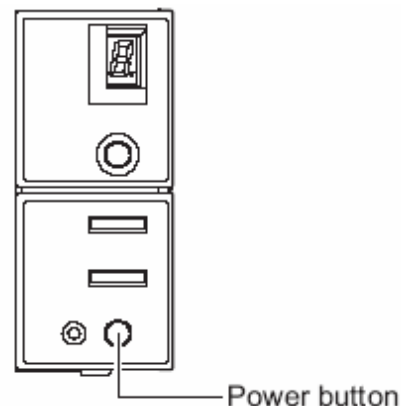

(2) Turning OFF the power

Hold the power button at least two seconds.

■ Power Save Mode

The Power Save mode keeps the scanner in a low-powered state if no operation is performed on the scanner for 15 minutes after it has been turned ON. The scanner is automatically switched to the Power Save mode.

In the Power Save mode, the indication of the Function No. display on the operator panel goes out, while the green LED is kept lit.

To return the scanner from the Power Save mode, perform one of the following operations:

- Load documents on the ADF paper chute (Chute unit).
- Press any button on the operator panel.
The scanner will be turned OFF when pressing down the power button for two seconds.
- Execute a command from the scanner driver.

05	Nov. 20, 2008	K.Okada	T.Anzai	I.Fujioka	Refer to Revision Record on page 2.	TITLE	fi-5530C/fi-5530C2 IMAGE SCANNER MAINTENANCE MANUAL		
04	July 7, 2008	K.Okada	T.Anzai	I.Fujioka	Refer to Revision Record on page 2.				
03	Feb.23, 2007	K.Okada	K.Okada	T.Anzai	Refer to Revision Record on page 2.				
						DRAW. No.	P1PA03334-B30X/6		CUST.
Rev	DATE	DESIG.	CHECK	APPR.	DESCRIPTION	PFU LIMITED		PAGE	22/138
DESIG	Aug.19, 2005	K.Okada	CHECK	K.Okada	APPR. T.Anzai				

1-6-2 Loading Documents for Scanning

1. Align the edge of the documents.

- 1) Confirm that all the documents have the same width.
- 2) Check the number of the sheets in the document stack.

The standard number of sheets that can be loaded on the scanner is as follows:

- A4-size paper or smaller that makes a document stack of 10mm or less (100 sheets at 80g/m² or at 20 lb)
- Over A4-size paper that makes a document stack of 5mm or less (50 sheets at 80g/m² or at 20 lb)

2. Fan the document as follows:

- 1) Lightly grip both ends of the documents with both hands, and bend the documents as shown on the right.

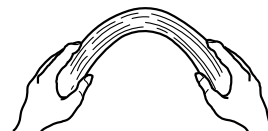

- 2) Hold the documents firmly with both hands and bend them back as shown on the right so that the bent section rises up in the middle of the stack.



- 3) Repeat steps 1) to 2) a couple of times.

- 4) Rotate documents 90 degrees, and fan again.

3. Align the top of the documents.

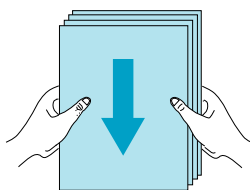

4. Load the documents on the ADF paper chute (Chute unit).

Set the documents face-down in the ADF paper chute (Chute unit) so that the side to be scanned faces towards the ADF paper chute (Chute unit).

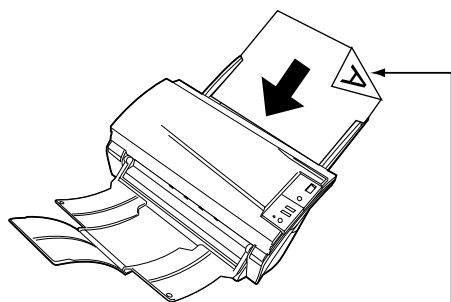

Load the documents facing the ADF paper chute.(face down)

Note: Set the documents so that the stack will not surpass the line mark located at the side guide.

For A4-size paper or smaller, set the documents so that the stack will not surpass the “Letter/A4/Smaller” line mark.

For paper over the A4-size, set the documents so that the stack will not surpass the “Over Letter/A4 Size” line mark.

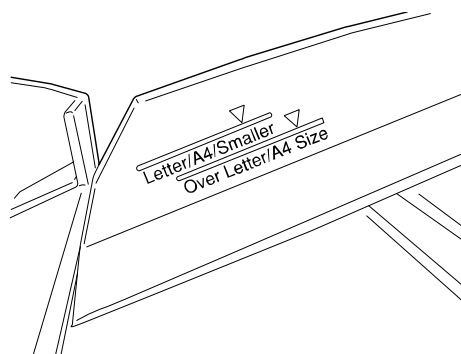

05	Nov. 20, 2008	K.Okada	T.Anzai	I.Fujioka	Refer to Revision Record on page 2.	TITLE	fi-5530C/fi-5530C2 IMAGE SCANNER MAINTENANCE MANUAL		
04	July 7, 2008	K.Okada	T.Anzai	I.Fujioka	Refer to Revision Record on page 2.	DRAW. No.	P1PA03334-B30X/6		CUST.
03	Feb.23, 2007	K.Okada	K.Okada	T.Anzai	Refer to Revision Record on page 2.				
Rev	DATE	DESIG.	CHECK	APPR.	DESCRIPTION	PFU LIMITED		PAGE	23/138
DESIG	Aug.19, 2005	K.Okada	CHECK	K.Okada	APPR. T.Anzai				

Hint: Before loading, pull out the ADF paper chute (Chute unit) extension according to the lengths of the documents.

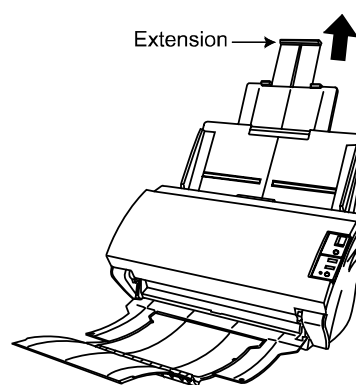

5. Adjust the side guides to the width of the documents.

Move the side guides so that they touch both sides of the documents.

If there is any clearance between the side guides and the edges of documents, the scanned image may be skewed.

Side guides

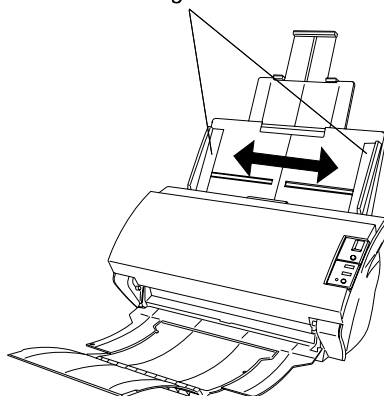

Hint: The stacker prevents document sheets from dropping after they were scanned.

Use the stacker as below.

1) Lift up the stacker towards you by inserting your fingertips into the handle on the scanner.

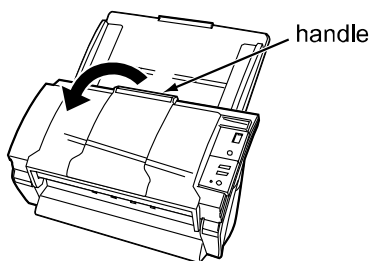

2) Lift the paper stop and swing forward by inserting your fingertips into the indentations on the stacker.

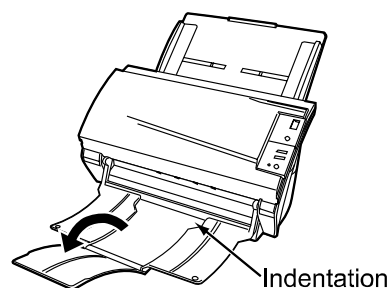

6. Start up the scanner application and scan the documents. 03

05	Nov. 20, 2008	K.Okada	T.Anzai	I.Fujioka	Refer to Revision Record on page 2.	TITLE	fi-5530C/fi-5530C2 IMAGE SCANNER MAINTENANCE MANUAL		
04	July 7, 2008	K.Okada	T.Anzai	I.Fujioka	Refer to Revision Record on page 2.	DRAW. No.	P1PA03334-B30X/6		CUST.
03	Feb.23, 2007	K.Okada	K.Okada	T.Anzai	Refer to Revision Record on page 2.				
Rev	DATE	DESIG.	CHECK	APPR.	DESCRIPTION	PFU LIMITED		PAGE	24/138
DESIG	Aug.19, 2005	K.Okada	CHECK	K.Okada	APPR. T.Anzai				

1-7 Daily Care

This section describes how to clean each part of the scanner.

WARNING

The glass surface inside the ADF becomes hot during the operation of the scanner. Before you start to clean the inner parts of the scanner, disconnect the AC adapter from the power outlet, and wait at least 15 minutes.

Do not turn off the scanner when you clean the Feed Rollers and Eject rollers.

Clean the ADF after every 5,000 scans. Without periodical cleaning, document feeding or transportation may be troubled.

The scanner must be cleaned more frequently if you scan any of the following type of sheets:

- Documents of coated paper
- Documents that are almost completely covered with printed text or graphics
- Chemically treated documents such as carbonless paper
- Documents containing a large amount of calcium carbonate
- Documents written by pencil
- Documents on which the toner is not fused sufficiently

1-7-1 Cleaning ADF

1. Open the ADF while pushing down the ADF button.

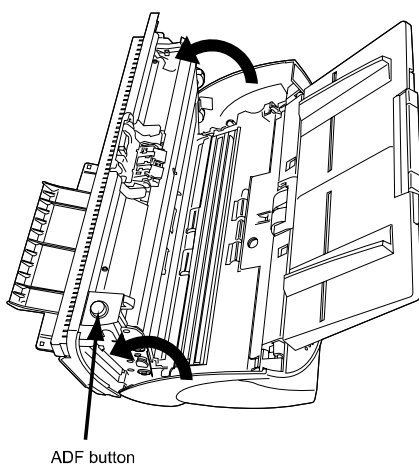

Caution: Be careful, the ADF cover may close and pinch your fingers.

2. Clean the following locations with a lint-free cloth moistened with ethyl alcohol isopropyl alcohol.

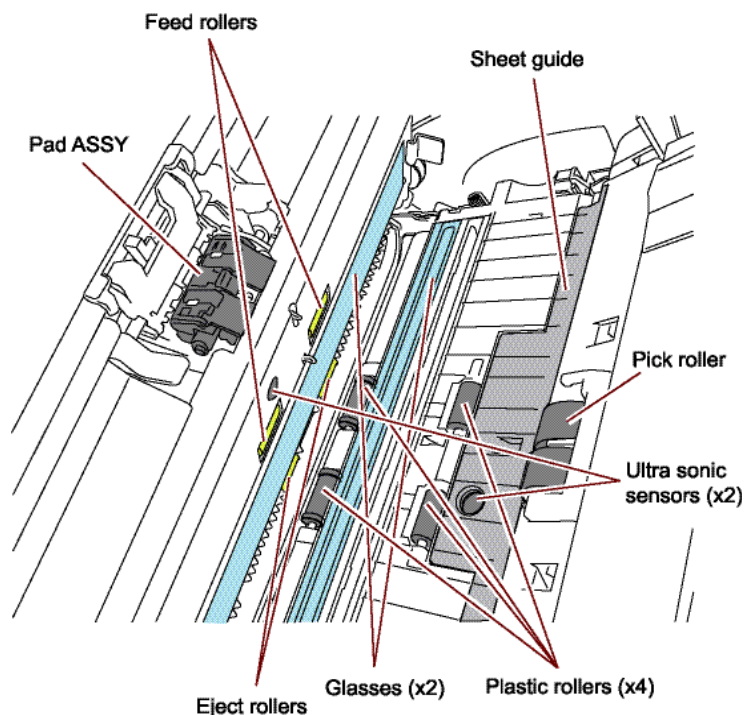

05	Nov. 20, 2008	K.Okada	T.Anzai	I.Fujioka	Refer to Revision Record on page 2.	TITLE	fi-5530C/fi-5530C2 IMAGE SCANNER MAINTENANCE MANUAL		
04	July 7, 2008	K.Okada	T.Anzai	I.Fujioka	Refer to Revision Record on page 2.	DRAW. No.	P1PA03334-B30X/6		CUST.
03	Feb.23, 2007	K.Okada	K.Okada	T.Anzai	Refer to Revision Record on page 2.				
Rev	DATE	DESIG.	CHECK	APPR.	DESCRIPTION	PFU LIMITED		PAGE	25/138
DESIG	Aug.19, 2005	K.Okada	CHECK	K.Okada	APPR. T.Anzai				

■ Pad ASSY

Clean the Pad ASSY (rubber surface) downward (in the direction of the arrow).

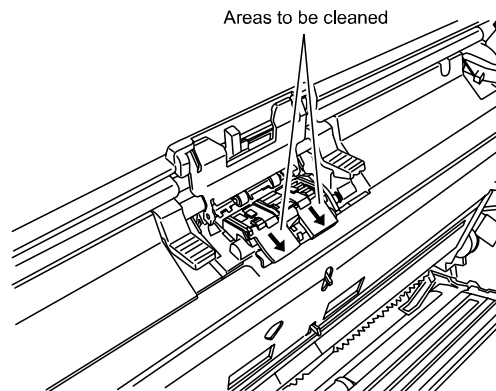

■ Pick rollers

Clean the Pick roller lightly, not to roughen the roller's surface. Take particular care in cleaning these rollers as black debris on them adversely affects pickup performance.

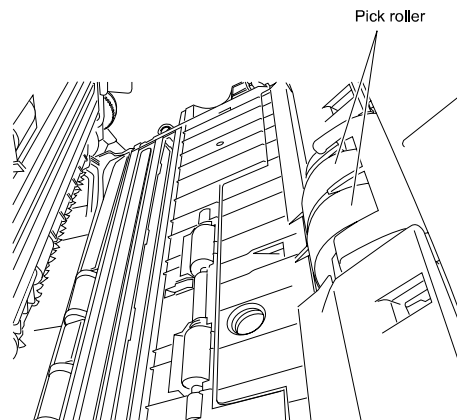

■ Feed and Eject rollers

Follow the procedure below while rotating the Feed and eject rollers.

- 1) Open the ADF when the indication of the Function Number display is not "P" or "0".
If you open the ADF when the indication of the Function Number display is "P" or "0", the Feed rollers/Eject rollers will not rotate even you perform the operation of step 2) below.
- 2) Simultaneously hold down the **Send to** and **Scan** buttons on the operator panel. The Feed rollers/Eject rollers start to rotate slowly.
- 3) Hold a soft, dry cloth moistened with cleaning fluid against the surface of the rotating Feed rollers/Eject rollers so that it lightly cleans the surface of the rollers.
As a guidance, 7 presses of the **Send to** and **Scan** buttons make the Feed rollers/Eject rollers to rotate one full turn.

Note: When cleaning the Eject rollers, be careful not to touch the Feed rollers and vice versa.

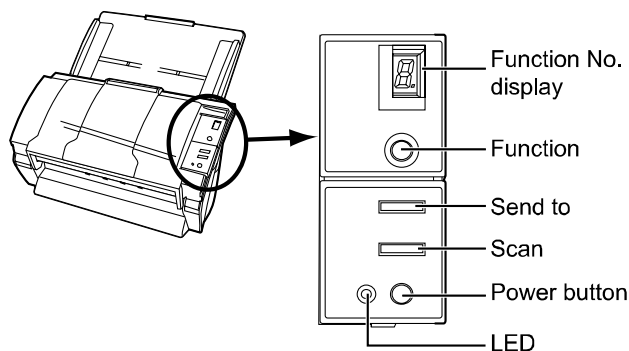

■ Plastic rollers

Clean the Plastic rollers lightly, not to roughen the roller surface. Take particular care in cleaning these rollers as black debris on them adversely affects the pickup performance. Be careful not to damage the sponges beside the rollers.

05	Nov. 20, 2008	K.Okada	T.Anzai	I.Fujioka	Refer to Revision Record on page 2.	TITLE	fi-5530C/fi-5530C2 IMAGE SCANNER MAINTENANCE MANUAL		
04	July 7, 2008	K.Okada	T.Anzai	I.Fujioka	Refer to Revision Record on page 2.				
03	Feb.23, 2007	K.Okada	K.Okada	T.Anzai	Refer to Revision Record on page 2.				
						DRAW. No.	P1PA03334-B30X/6	CUST.	
Rev	DATE	DESIG.	CHECK	APPR.	DESCRIPTION	PFU LIMITED		PAGE	26/138
DESIG	Aug.19, 2005	K.Okada	CHECK	K.Okada	APPR. T.Anzai				

- Sheet guide (Guide P ASSY)
Clean lightly.
- Glass
Clean lightly.

Note: If the glass is dirty, vertical black streaks may appear in the scanned images.

- Ultra sonic sensor
Clean lightly with a dry cloth.

3. Push in center of the ADF to return it to its original position, until the ADF button locks.

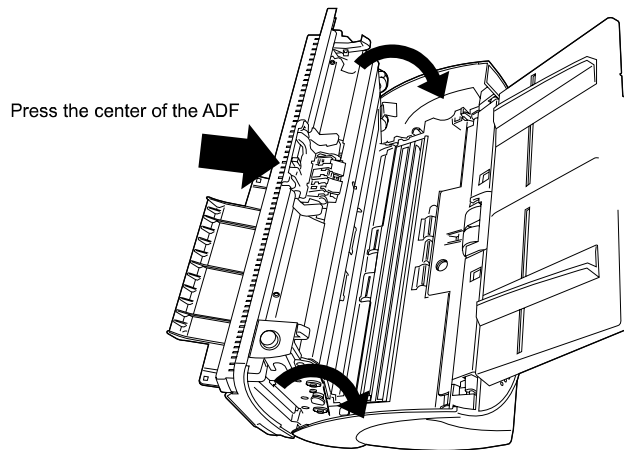

Note: Close the ADF until it clicks. Paper jams or feeding errors may occur if the ADF is not closed completely.

05	Nov. 20, 2008	K.Okada	T.Anzai	I.Fujioka	Refer to Revision Record on page 2.	TITLE fi-5530C/fi-5530C2 IMAGE SCANNER MAINTENANCE MANUAL	DRAW. No. P1PA03334-B30X/6	CUST.
04	July 7, 2008	K.Okada	T.Anzai	I.Fujioka	Refer to Revision Record on page 2.			
03	Feb.23, 2007	K.Okada	K.Okada	T.Anzai	Refer to Revision Record on page 2.			
Rev	DATE	DESIG.	CHECK	APPR.	DESCRIPTION	PFU LIMITED	PAGE	27/138
DESIG	Aug.19, 2005	K.Okada	CHECK	K.Okada	APPR. T.Anzai			

1-8 Replacing the Consumables

1-8-1 Consumables

The scanner has the following consumables which users need to replace at the following intervals when the screen on the right appears. To check the number of scanned documents, go to Maintenance mode ([Section 5-1-6](#)) or the Properties of [Scanners and Cameras] on the Control panel (Appendix A).

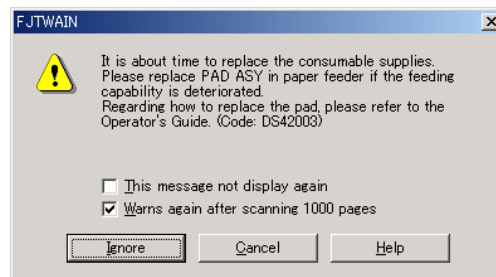

Table 1-8-1 Consumables

No.	Part name	Specifications	Standard replacement cycle	How to check the number of scanned documents	How to replace
1	Pad ASSY	PA03334-0002	100,000 scans or one year	See Section 5-1-6 .	See Section 1-8-2
2	Pick roller	PA03334-0001	200,000 sheets or one year		See Section 1-8-3

The replacement cycles above are rough guidelines for the case of using A4/Letter woodfree or wood containing paper 64g/m² (17lb). This cycle varies according to the type of the scanned paper and how frequently the scanner is used and cleaned.

Note: Use only the specified consumables to avoid document feeding trouble.

WARNING

When operating the scanner, the glass inside the ADF becomes very hot. Before you replace the consumables, turn off the power and unplug the AC adapter from the outlet. Wait for at least 15 minutes.

1-8-2 Replacing Pad ASSY

Refer to [Section 1-8-2](#) for the specification of the Pad ASSY.

1. Remove all documents on the ADF paper chute (Chute unit).
2. Open the ADF by pushing the ADF button.

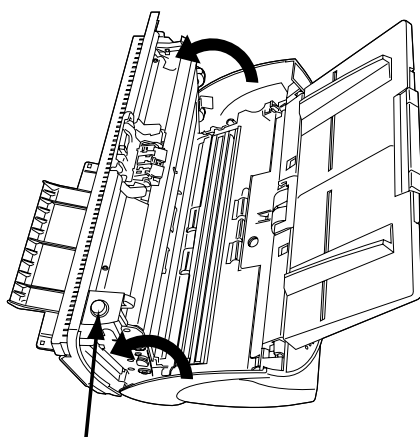

NOTICE

Be careful, the ADF cover may close and pinch your fingers.

05	Nov. 20, 2008	K.Okada	T.Anzai	I.Fujioka	Refer to Revision Record on page 2.	TITLE fi-5530C/fi-5530C2 IMAGE SCANNER MAINTENANCE MANUAL	DRAW. No. P1PA03334-B30X/6	CUST.
04	July 7, 2008	K.Okada	T.Anzai	I.Fujioka	Refer to Revision Record on page 2.			
03	Feb.23, 2007	K.Okada	K.Okada	T.Anzai	Refer to Revision Record on page 2.			
Rev	DATE	DESIG.	CHECK	APPR.	DESCRIPTION	PFU LIMITED	PAGE	28/138
DESIG	Aug.19, 2005	K.Okada	CHECK	K.Okada	APPR. T.Anzai			

3. Remove the Pad ASSY.

Pinch the Pad ASSY and slide it to the direction of the arrow and remove it.

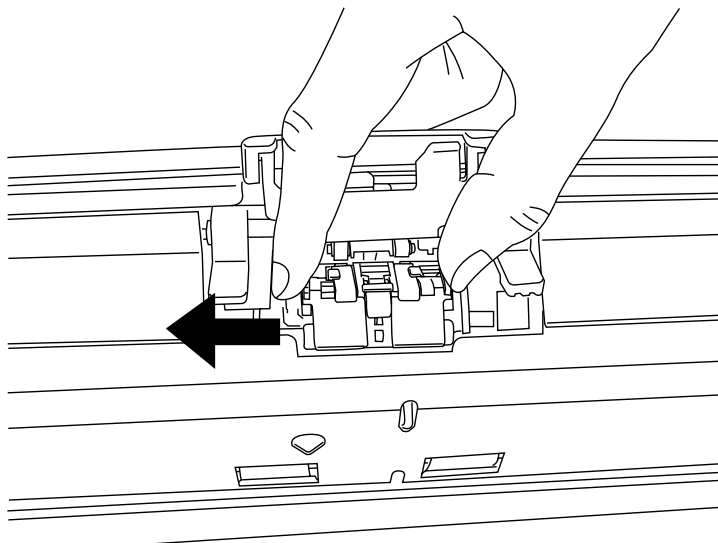

4. Attach new Pad ASSY.

Insert the claws of the Pad ASSY into the holes on the ADF.

Pressing down the Pad ASSY and slide it to direction "A" as shown in the illustration above.

Note: Make sure that the Pad ASSY is firmly attached. When the Pad ASSY is not correctly attached, document jams or other feeding errors may occur.

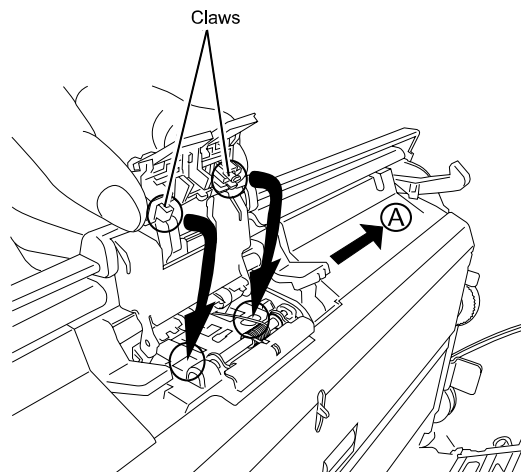

5. Push in the center of the ADF to close it until the ADF button is locked.

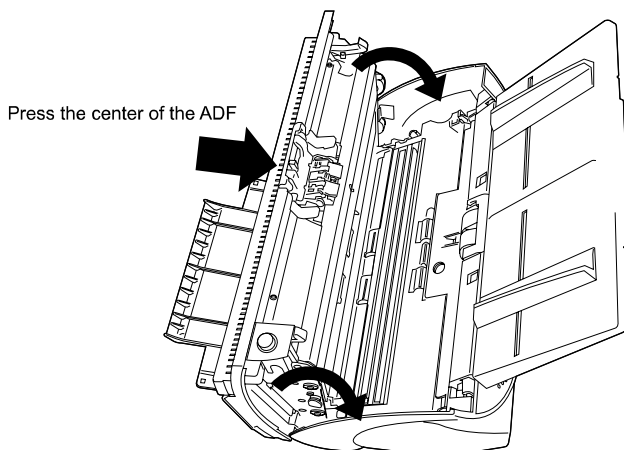

6. Reset the Pad counter by referring to [Section 1-8-4](#) or [Section 5-1-6](#).

05	Nov. 20, 2008	K.Okada	T.Anzai	I.Fujioka	Refer to Revision Record on page 2.	TITLE	fi-5530C/fi-5530C2 IMAGE SCANNER MAINTENANCE MANUAL		
04	July 7, 2008	K.Okada	T.Anzai	I.Fujioka	Refer to Revision Record on page 2.				
03	Feb.23, 2007	K.Okada	K.Okada	T.Anzai	Refer to Revision Record on page 2.				
						DRAW. No.	P1PA03334-B30X/6		CUST.
Rev	DATE	DESIG.	CHECK	APPR.	DESCRIPTION	PFU LIMITED		PAGE	29/138
DESIG	Aug.19, 2005	K.Okada	CHECK	K.Okada	APPR. T.Anzai				

1-8-3 Replacing Pick roller

Refer to [Section 1-8-2](#) for the specification of the Pick roller.

1. Remove all documents from the ADF paper chute (Chute unit).
2. Remove the ADF paper chute (Chute unit). (Refer to [Section 4-7-1](#))
3. Open the ADF by pushing down the ADF button.

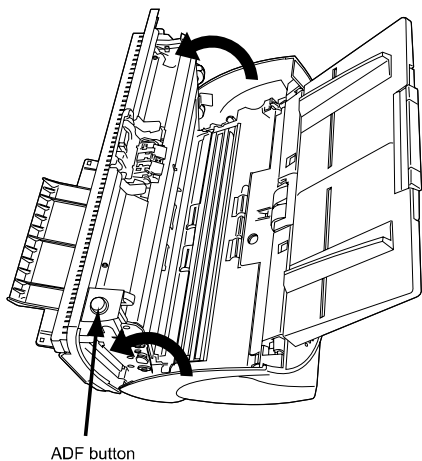
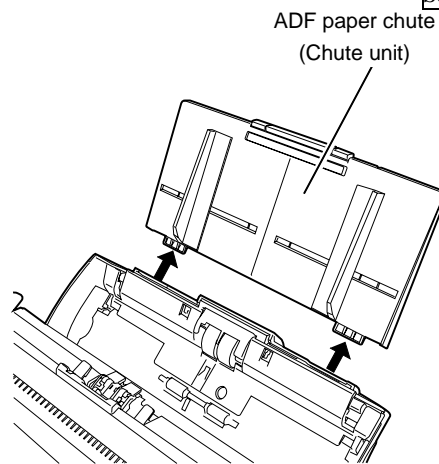

NOTICE

Be careful, the ADF cover may close and pinch your fingers.

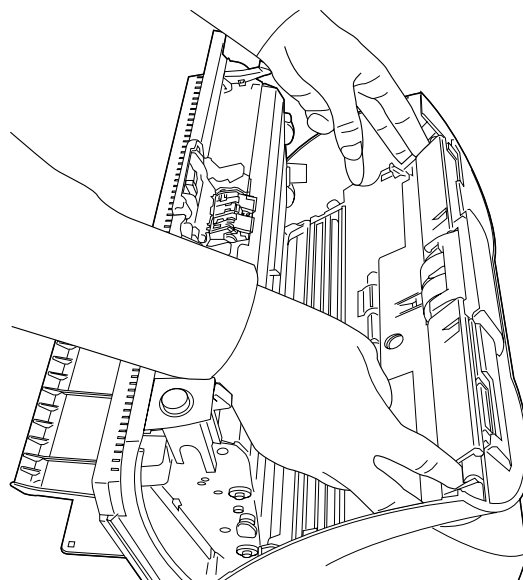

4. Remove the Pick roller from the scanner.
 - 1) Pinch the knobs on the sheet guide (Guide P ASSY) and lift up the sheet guide (Guide P ASSY) to remove it.

- 2) Rotate the Pick roller bushing in the direction of the arrow.

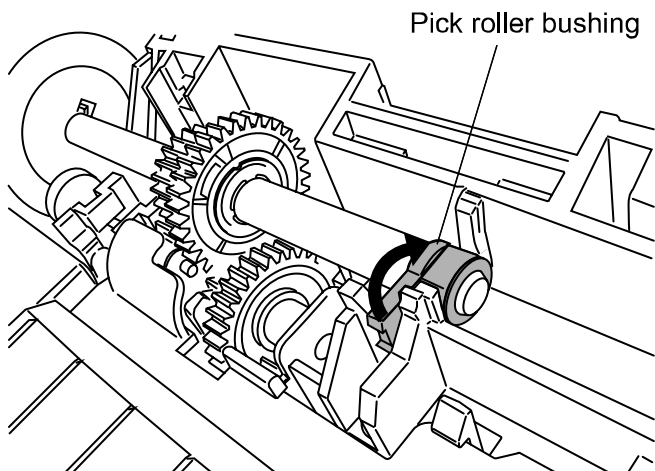

05	Nov. 20, 2008	K.Okada	T.Anzai	I.Fujioka	Refer to Revision Record on page 2.	TITLE	fi-5530C/fi-5530C2 IMAGE SCANNER MAINTENANCE MANUAL		
04	July 7, 2008	K.Okada	T.Anzai	I.Fujioka	Refer to Revision Record on page 2.	DRAW. No.	P1PA03334-B30X/6		CUST.
03	Feb.23, 2007	K.Okada	K.Okada	T.Anzai	Refer to Revision Record on page 2.				
Rev	DATE	DESIG.	CHECK	APPR.	DESCRIPTION	PFU LIMITED		PAGE	30/138
DESIG	Aug.19, 2005	K.Okada	CHECK	K.Okada	APPR. T.Anzai				

3) Remove the Pick roller shaft while lifting it up in the direction of the arrow.

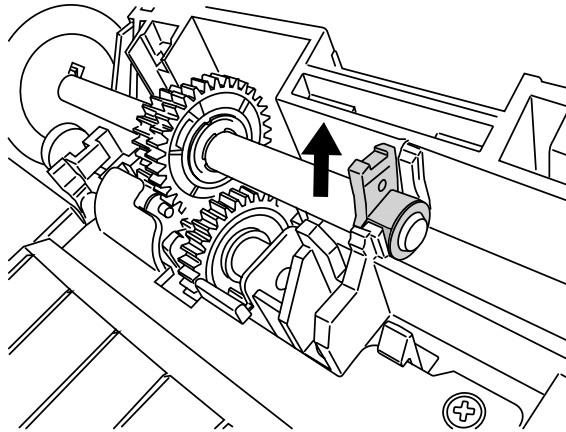

Note: As the Pick roller bushing is firmly fixed, do not try to turn the roller bushing with your fingernails. Use a paper clip for the roller bushing if you cannot rotate it with your finger.

5. Remove the Pick roller from the shaft while lifting up the tab on the Pick roller.

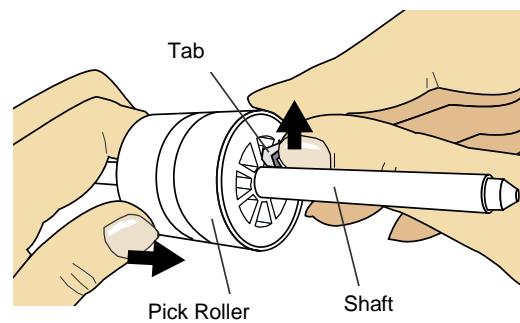

Note: If you lift the pick roller tab with your fingernail, it may hurt your fingernail. Use a paper clip to lift the pick roller tab if you cannot do it with your finger.

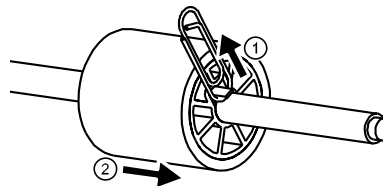

6. Attach new Pick roller.

Insert new Pick roller aligning the screw on the shaft with the slot in the Pick roller.

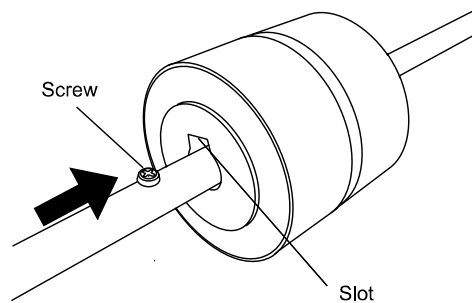

05	Nov. 20, 2008	K.Okada	T.Anzai	I.Fujioka	Refer to Revision Record on page 2.	TITLE fi-5530C/fi-5530C2 IMAGE SCANNER MAINTENANCE MANUAL	DRAW. No. P1PA03334-B30X/6	CUST.
04	July 7, 2008	K.Okada	T.Anzai	I.Fujioka	Refer to Revision Record on page 2.			
03	Feb.23, 2007	K.Okada	K.Okada	T.Anzai	Refer to Revision Record on page 2.			
Rev	DATE	DESIG.	CHECK	APPR.	DESCRIPTION	PFU LIMITED	PAGE	31/138
DESIG	Aug.19, 2005	K.Okada	CHECK	K.Okada	APPR. T.Anzai			

Note: Make sure that the Pick roller is correctly attached. The incompletely-attached Pick roller might cause the document jams or other feed errors. When attaching the Pick roller to the shaft, make sure that the roller's tab clicks in to place.

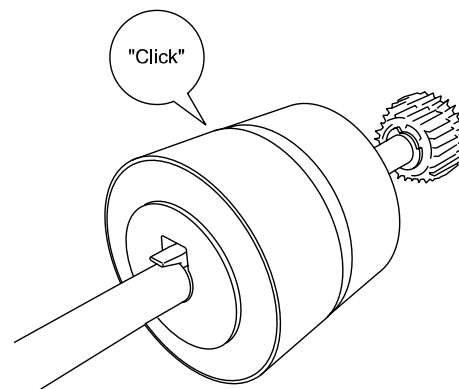

7. Attach the Pick roller shaft to the scanner.

Attach the Pick roller shaft to the scanner in reverse order of removing.

- 1) Set the Pick roller inserting an end of shaft into the shaft hole.

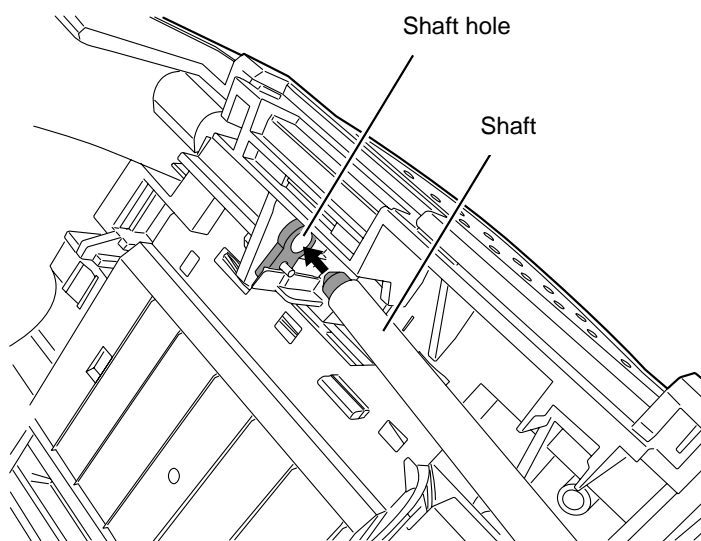

- 2) Turn the Pick roller bushing in the direction of the arrow.

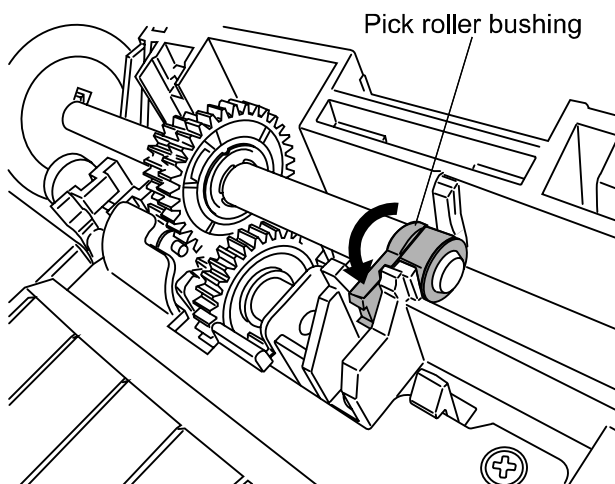

- 3) Attach the sheet guide (Guide P ASSY).

05	Nov. 20, 2008	K.Okada	T.Anzai	I.Fujioka	Refer to Revision Record on page 2.	TITLE	fi-5530C/fi-5530C2 IMAGE SCANNER MAINTENANCE MANUAL		
04	July 7, 2008	K.Okada	T.Anzai	I.Fujioka	Refer to Revision Record on page 2.				
03	Feb.23, 2007	K.Okada	K.Okada	T.Anzai	Refer to Revision Record on page 2.				
						DRAW. No.	P1PA03334-B30X/6		CUST.
Rev	DATE	DESIG.	CHECK	APPR.	DESCRIPTION	PFU LIMITED		PAGE	32/138
DESIG	Aug.19, 2005	K.Okada	CHECK	K.Okada	APPR. T.Anzai				

8. Push in the center of the ADF to close it until the ADF button is locked.

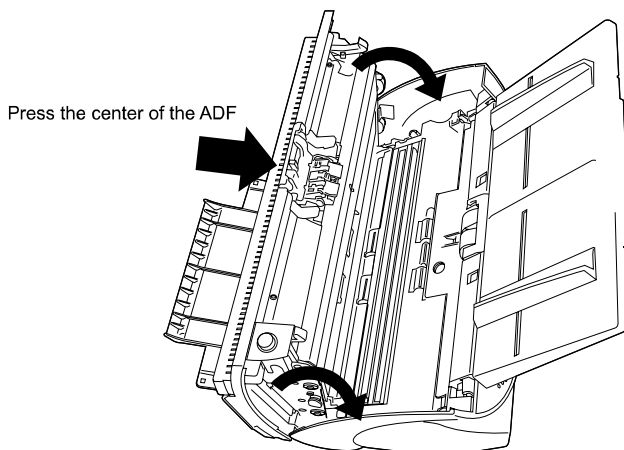

9. Attach the ADF paper chute (Chute unit) to the scanner.

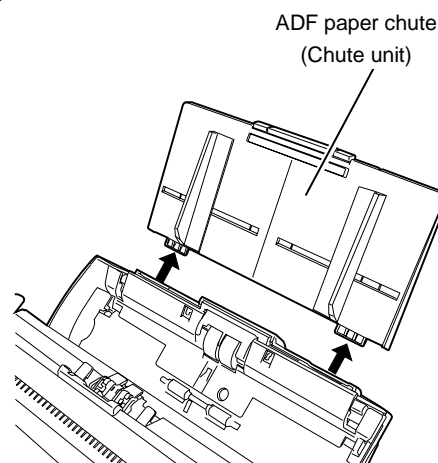

10. Reset the pick counter by referring to [Section 1-8-4](#) and [Section 5-1-6](#).

1-8-4 Resetting Consumable Counters

For Windows 98/Windows Me/Windows 2000/Windows XP (example)

Note: For Windows 95/Windows NT 4.0, perform it on the FUJITSU Scanner Control Center.

1. Check that the scanner is connected to your PC and turn ON the scanner.
2. Open the [Scanners and Cameras] from the control panel of your PC.
3. Open the [Properties] of [fi-5530Cdj] from the [Scanners and Cameras].
 → The [fi-5530Cdj Properties] dialog box appears.
4. Click the “Device Set” tab.
 → The window on the right appears.

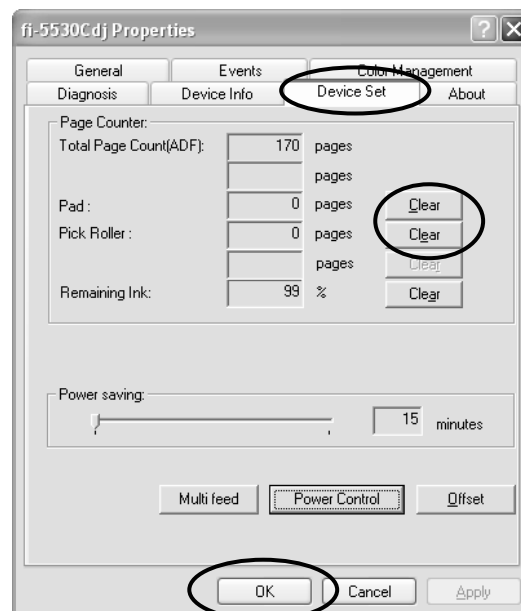

5. After clicking the [Clear] button beside [Pad] or [Pick Roller] in “Page Counter”, click the [OK] button, then also click the [OK] button on the next screen.
 → The selected counter returns to “0”.

05	Nov. 20, 2008	K.Okada	T.Anzai	I.Fujioka	Refer to Revision Record on page 2.	TITLE	fi-5530C/fi-5530C2 IMAGE SCANNER MAINTENANCE MANUAL		
04	July 7, 2008	K.Okada	T.Anzai	I.Fujioka	Refer to Revision Record on page 2.	DRAW. No.	P1PA03334-B30X/6		CUST.
03	Feb.23, 2007	K.Okada	K.Okada	T.Anzai	Refer to Revision Record on page 2.				
Rev	DATE	DESIG.	CHECK	APPR.	DESCRIPTION	PFU LIMITED		PAGE	33/138
DESIG	Aug.19, 2005	K.Okada	CHECK	K.Okada	APPR. T.Anzai				

Chapter 2 Description of scanner operation

2-1 ADF unit

(1) Paper separation

When scanning, bottom sheet of the document loaded on the ADF paper chute (Chute unit) is picked by the Pick roller and Pad ASSY and fed into the ADF. Picked document is transported by the feed roller and ejection roller at the speed that corresponds to a specified output resolution until they are ejected to the stacker. ADF unit includes Sensor TOP for page edge detection, Sensor PICK for picking detection, Sensor EM for paper empty detection, US sensors for multi feed detection and Cover open sensor. For document specification refer to [Section 1-2](#).

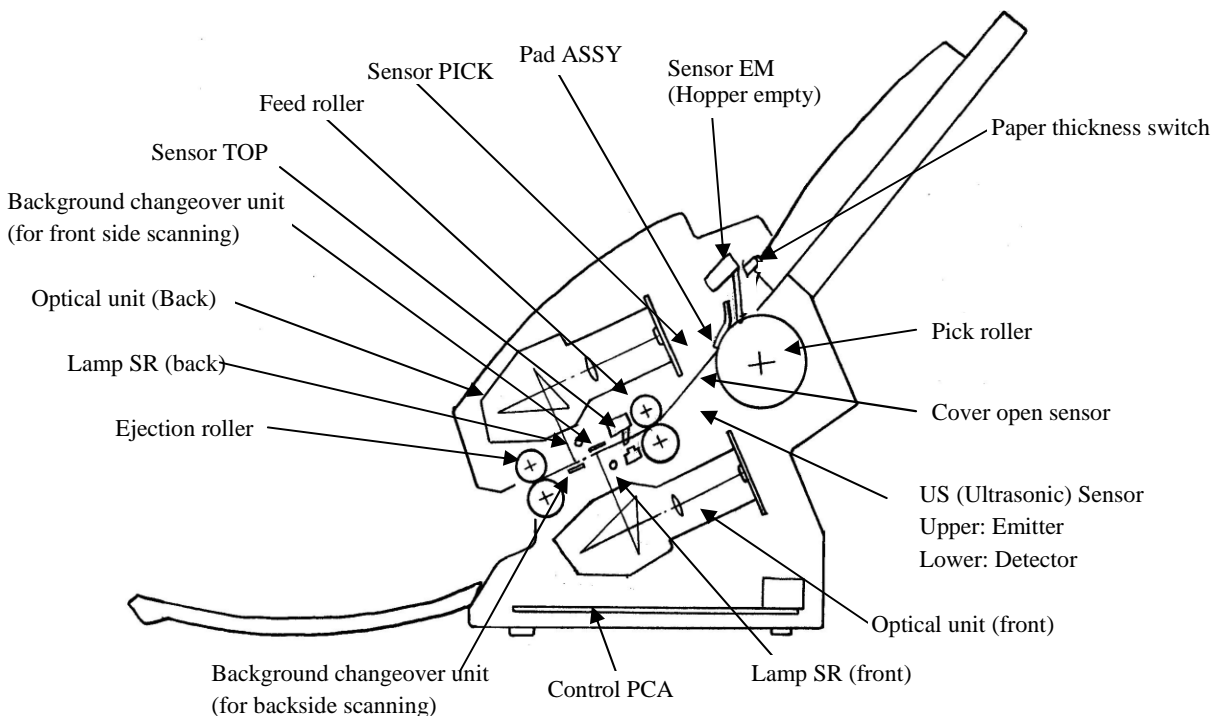

(2) Consumables

The Pick roller and Pad ASSY are the consumables and replaced by user. (Refer to [Section 1-8-1](#) for detail)

The scanner supports two consumable counters, Pad counter and Pick counter, to indicate the number of sheets that have been scanned from the last consumable replacement. Those counters are checked by the driver for user, or by Maintenance mode #5 (See [Section 5-1-6](#)) for service person. After replacing the consumable these counter shall be reset.

(3) Drive unit

The Pick roller is driven by the Pick motor, and feed roller and ejection roller are driven by the LF motor. The motor drive circuit and motor fuse are located in the Control PCA. If abnormal electric current runs through the motor drive circuit, the current is cut off by the motor fuse.

(4) Paper thickness switch

When the paper is thinner than described in [Section 1-2-2](#), this switch may be effective. This does not assure the scanning of the thin paper out of the paper specification described in [Section 1-2](#). See [Section 1-1\(4\)](#) for detail.

05	Nov. 20, 2008	K.Okada	T.Anzai	I.Fujioka	Refer to Revision Record on page 2.	TITLE	fi-5530C/fi-5530C2 IMAGE SCANNER MAINTENANCE MANUAL		
04	July 7, 2008	K.Okada	T.Anzai	I.Fujioka	Refer to Revision Record on page 2.	DRAW. No.	P1PA03334-B30X/6		CUST.
03	Feb.23, 2007	K.Okada	K.Okada	T.Anzai	Refer to Revision Record on page 2.				
Rev	DATE	DESIG.	CHECK	APPR.	DESCRIPTION	PFU LIMITED	PAGE	34/138	
DESIG	Aug.19, 2005	K.Okada	CHECK	K.Okada	APPR. T.Anzai				

2-2 Reading station

(1) Optical system

Documents are set in the ADF paper chute (Chute unit) facing front side down. The front side of a document is read by the Optical unit in the Base unit, and the backside of a document is read by the Optical unit in the Upper unit. These two optical units have the same parts number.

An image on a document is projected to a color CCD through lens and mirror system, and the image is converted to signals with 10 bit per pixel at 600 dpi resolution.

(2) Light source

The scanner uses two lamps (White cold cathode discharge lamps), which lights the scanning area where the optical unit reads in order to get sufficient CCD output. The lamp is turned ON or OFF by Inverter that is controlled by the Control PCA.

The life of lamp is about 10000 hours, which lasts through the life of device. So the lamp is not a consumable.

(3) Gain controller

Before scanning a document, the scanner reads white background of the reading position (front and back) and adjusts the gain of CCD amplifier. If the CCD output does not reach a certain level after the gain adjustment, Optical alarm is issued.

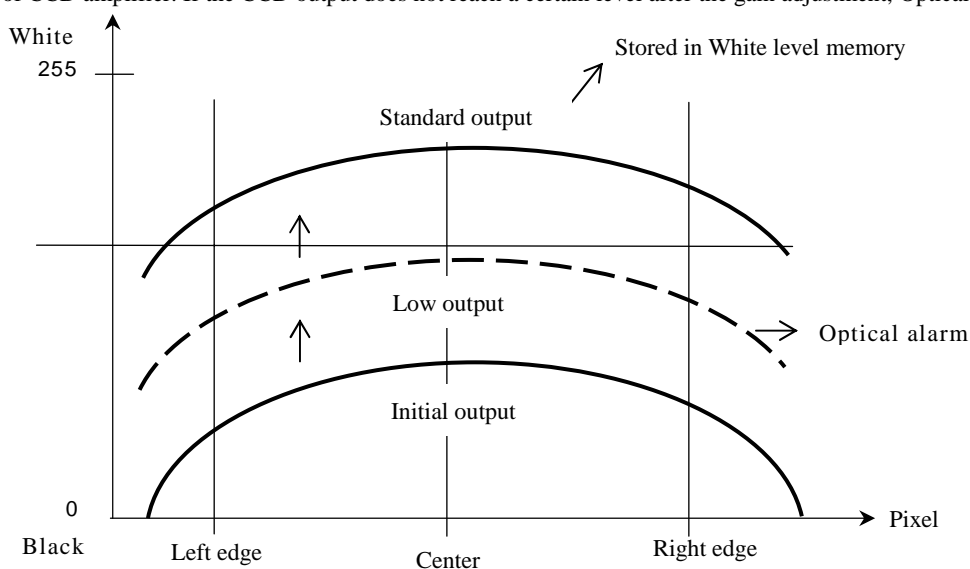

When the gain adjustment finishes successfully, the scanner feeds the document to the reading position at pre-determined speed for specified output resolution. Then the leading edge of the document is detected by the Sensor TOP before the reading position. When the document is fed from Sensor TOP by some pre-defined length (for front and back side scanning which is determined by sub-scanning offset correction value), the scanner starts reading image. The scanner terminates reading operation when the document size specified from the host is scanned (Standard size scanning), or when the Sensor TOP detects the trailing edge of a document (Page end detection scanning).

05	Nov. 20, 2008	K.Okada	T.Anzai	I.Fujioka	Refer to Revision Record on page 2.	TITLE	fi-5530C/fi-5530C2 IMAGE SCANNER MAINTENANCE MANUAL		
04	July 7, 2008	K.Okada	T.Anzai	I.Fujioka	Refer to Revision Record on page 2.				
03	Feb.23, 2007	K.Okada	K.Okada	T.Anzai	Refer to Revision Record on page 2.				
						DRAW. No.	P1PA03334-B30X/6		CUST.
Rev	DATE	DESIG.	CHECK	APPR.	DESCRIPTION	PFU LIMITED		PAGE	35/138
DESIG	Aug.19, 2005	K.Okada	CHECK	K.Okada	APPR. T.Anzai				

2-3 Controller

(1) Control PCA

The functional block diagram of Control PCA is shown in the figure below. Control PCA includes the following connectors and a switch.

- SCSI connector
- USB connector
- DC voltage input connector
- SCSI ID setting rotary switch

If both SCSI and USB cables are connected,

- SCSI is selected when selection phase is recognized first.
- USB is selected when H level VBUS signal is detected first.

The firmware can be updated through a SCSI/USB interface using Firmware update tool.

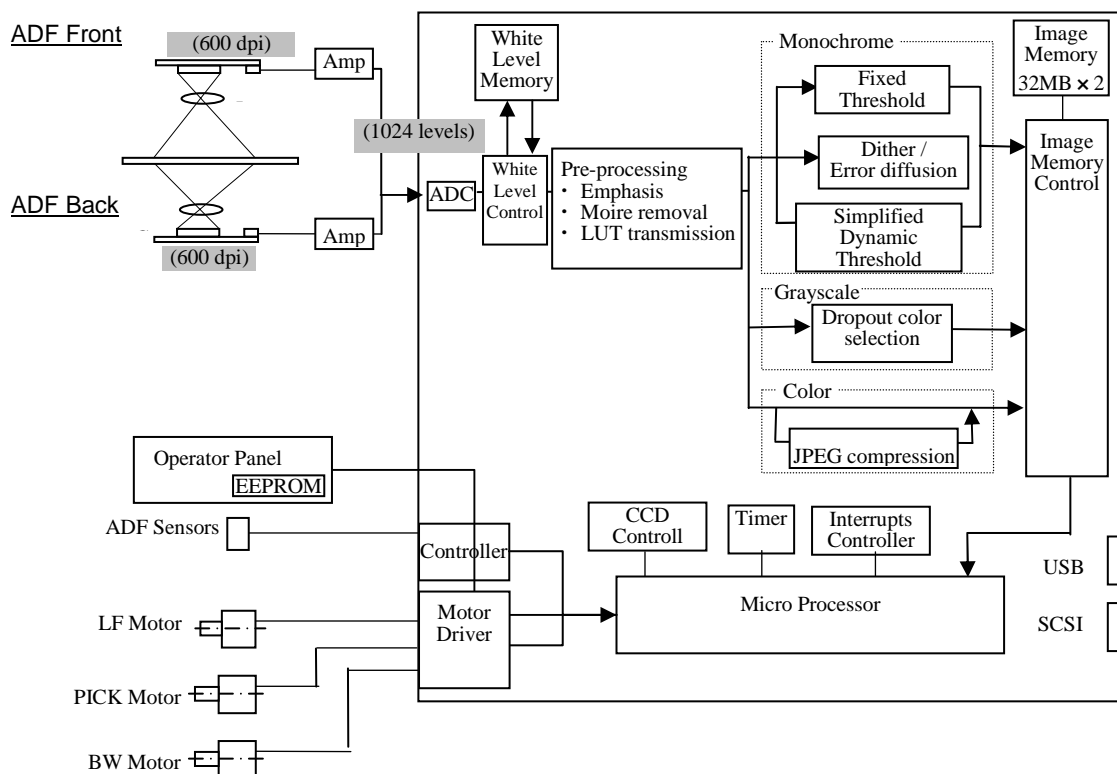

Figure 2-3A

05	Nov. 20, 2008	K.Okada	T.Anzai	I.Fujioka	Refer to Revision Record on page 2.	TITLE fi-5530C/fi-5530C2 IMAGE SCANNER MAINTENANCE MANUAL	DRAW. No. P1PA03334-B30X/6	CUST.
04	July 7, 2008	K.Okada	T.Anzai	I.Fujioka	Refer to Revision Record on page 2.			
03	Feb.23, 2007	K.Okada	K.Okada	T.Anzai	Refer to Revision Record on page 2.			
Rev	DATE	DESIG.	CHECK	APPR.	DESCRIPTION	PFU LIMITED	PAGE	36/138
DESIG	Aug.19, 2005	K.Okada	CHECK	K.Okada	APPR. T.Anzai			

(2) Panel PCA

The Panel PCA in operator panel includes not only the switch and display unit described in [Section 1-1](#), but also EEPROM that records the information below. Before replacing the Panel PCA, you need to move all data stored in the EEPROM to the Control PCA (See [Section 5-2](#)), and then return the data from the Control PCA to new Panel PCA (See [Section 5-1-8](#)) after the replacement. (Refer to [Section 5-1-8](#) and [5-2](#))

- Magnification correction value for main/sub scanning direction
- Offset correction value for main/sub scanning direction
- White level correction value
- Values of Pad counter, Pick counter, Roller kit counter and Ink remainder counter
- First date of the scanner operation, ADF scanned sheets of documents, Error history

(3) Multi feed detection

Multi feed is detected by US Sensor and Sensor TOP. There is US PCA to amplify the signal from lower US sensor. Refer to [Section 3-2-1](#) for details.

(4) Background changeover unit

The background color (white and Black) for front and backside scanning is switched by the command from host computer. Mechanism operation can be confirmed by Maintenance mode #1 ([Section 5-1-2](#)).

(5) Emulation

03

03

When user replace following scanners with fi-5530C/fi-5530C2, the connection of fi-5530C/fi-5530C2 can fail due to the old PC system. Emulation mode can accommodate the connection for that case. This mode is not open to user. This mode may not be used for maintenance, but refer to [Section 5-3](#) if required.

Models supported by fi-5530C2

- fi-4530C
- fi-4120C
- fi-4120C2
- M3096GX
- M3093GX

Models supported by fi-5530C

- fi-4530C
- fi-5530C 03
- fi-4120C
- fi-4120C2
- fi-5120C 03
- M3096GX
- M3093GX

05	Nov. 20, 2008	K.Okada	T.Anzai	I.Fujioka	Refer to Revision Record on page 2.	TITLE	fi-5530C/fi-5530C2 IMAGE SCANNER MAINTENANCE MANUAL		
04	July 7, 2008	K.Okada	T.Anzai	I.Fujioka	Refer to Revision Record on page 2.				
03	Feb.23, 2007	K.Okada	K.Okada	T.Anzai	Refer to Revision Record on page 2.				
						DRAW. No.	P1PA03334-B30X/6		CUST.
Rev	DATE	DESIG.	CHECK	APPR.	DESCRIPTION	PFU LIMITED		PAGE	37/138
DESIG	Aug.19, 2005	K.Okada	CHECK	K.Okada	APPR. T.Anzai				

2-4 Electric Component Block Diagram

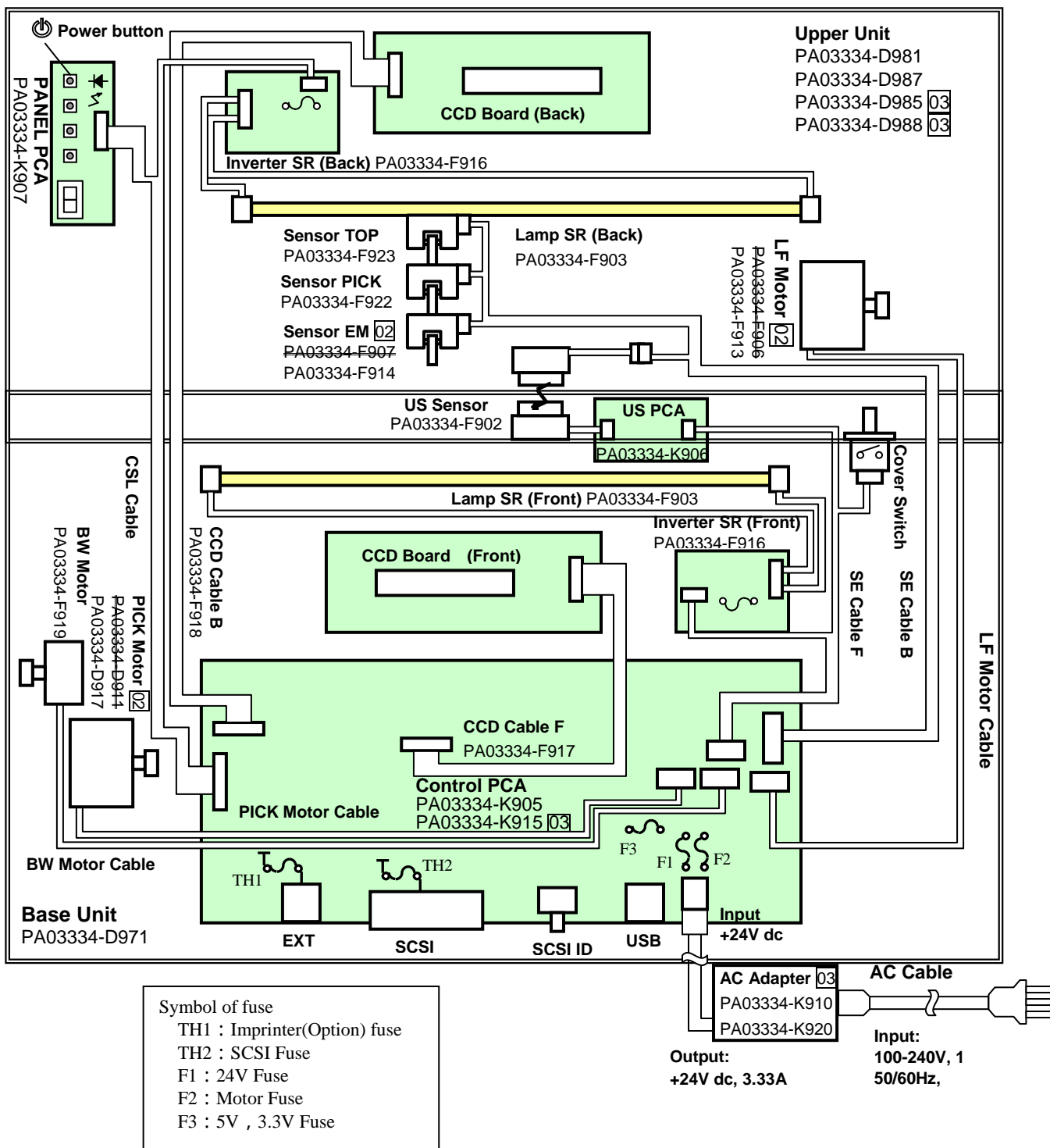

05	Nov. 20, 2008	K.Okada	T.Anzai	I.Fujioka	Refer to Revision Record on page 2.	TITLE	fi-5530C/fi-5530C2 IMAGE SCANNER MAINTENANCE MANUAL		
04	July 7, 2008	K.Okada	T.Anzai	I.Fujioka	Refer to Revision Record on page 2.	DRAW. No.	P1PA03334-B30X/6		CUST.
03	Feb.23, 2007	K.Okada	K.Okada	T.Anzai	Refer to Revision Record on page 2.				
Rev	DATE	DESIG.	CHECK	APPR.	DESCRIPTION	PFU LIMITED		PAGE	38/138
DESIG	Aug.19, 2005	K.Okada	CHECK	K.Okada	APPR. T.Anzai				

Chapter 3 Troubleshooting

3-1 Self-diagnosis function

3-1-1. Scanner status display and self-diagnostics at power-on

(1) Operator panel display sequence at power-on

The following display is shown during initial processing.

Function No. Display	Power LED	Description
	ON	Displays "8" without blinking. Immediately after power-on, scanner turns all the segments ON.

When the initial processing starts, the following display appears.

Function No. Display	Power LED	Description
	ON	Displays "P" without blinking. It indicates scanner is currently in initial processing.

When the lamp intensity is getting close to the standard value, the following display appears.

Function No. Display	Power LED	Description
	ON	Displays "0" without blinking. It indicates the lamp intensity is getting close to the standard value.

When the initial processing terminates properly, the following display appears.

Function No. Display	Power LED	Description
	ON	Displays default Function No. without blinking. The scanner is in Ready state. The function No. "1" (default) is displayed.

The Function No. increments by 1 every time the Function button is pressed. After Function No. 9 is displayed, the number changes to "C" and then returns to "1".

05	Nov. 20, 2008	K.Okada	T.Anzai	I.Fujioka	Refer to Revision Record on page 2.	TITLE fi-5530C/fi-5530C2 IMAGE SCANNER MAINTENANCE MANUAL	DRAW. No. P1PA03334-B30X/6	CUST.
04	July 7, 2008	K.Okada	T.Anzai	I.Fujioka	Refer to Revision Record on page 2.			
03	Feb.23, 2007	K.Okada	K.Okada	T.Anzai	Refer to Revision Record on page 2.			
Rev	DATE	DESIG.	CHECK	APPR.	DESCRIPTION	PFU LIMITED	PAGE	39/138
DESIG	Aug.19, 2005	K.Okada	CHECK	K.Okada	APPR. T.Anzai			

(2) Self-diagnostics

The scanner checks the following items at power-on and displays error or alarm if any.

No.	Check items	Error display on Scanner	Remarks
1	ROM sum check	F	
2	SPC check	Ed	
3	RAM, LSI check	Ec	
4	Image SD RAM check	E9	
5	EEPROM check	E7	
6	Imprinter check	EA	Only when the imprinter is installed
7	Background changeover unit check	EF	
8	Mechanical initial check	Ejects any documents on TOP sensor	None
		Performs driving test for rollers if no sensor in the ADF detects any paper.	E4
9 (*1)	Motor fuse check	E4	
	SCSI fuse check	E8	

*1: When 5V, 3.3V fuse is blown, the scanner does not turn on.

3-1-2. Online self-diagnostics**(1) Self-diagnostics when receiving Load Command**

The scanner checks the following items when receiving Load Command (to feed paper) and displays the result if any error or alarm is detected.

No.	Check items	Error display on Scanner	Remarks
1	Motor fuse check	E4	
2	Paper jam check	U1	
3	ADF cover open check	U4	

(2) Self-diagnostics when receiving Read Command

The scanner checks the following items when receiving Read Command (to start scanning) and displays the result if any error or alarm is detected.

No.	Check items	Error display on Scanner	Remarks
1	Light intensity check (Gain adjustment for CCD amplifier)	E2	Front side
		E3	Backside
2	Motor fuse check	E4	
3	Paper jam check	U1	
4	Multi feed error	U2	Effective when multi feed detection is valid
5	ADF cover open check	U4	
6	Imprinter check	EA	Only when imprinter is installed.

05	Nov. 20, 2008	K.Okada	T.Anzai	I.Fujioka	Refer to Revision Record on page 2.	TITLE fi-5530C/fi-5530C2 IMAGE SCANNER MAINTENANCE MANUAL	DRAW. No. P1PA03334-B30X/6	CUST.
04	July 7, 2008	K.Okada	T.Anzai	I.Fujioka	Refer to Revision Record on page 2.			
03	Feb.23, 2007	K.Okada	K.Okada	T.Anzai	Refer to Revision Record on page 2.			
Rev	DATE	DESIG.	CHECK	APPR.	DESCRIPTION	PFU LIMITED	PAGE	40/138
DESIG	Aug.19, 2005	K.Okada	CHECK	K.Okada	APPR. T.Anzai			

3-1-3. Self-diagnostics in Maintenance mode

The scanner checks the following errors/alarms during maintenance mode and displays the result if any error/alarm is detected.

No.	Check items		Maintenance mode			Error display on Scanner	Remarks
			At power on	#1 (*2)	#2 ~ #4		
1	ROM sum check		√			F	
2	RAM, LSI check		√			Ec	
3	Image SDRAM check		√			E9	
4	EEPROM check		√			E7	
5	Mechanical check	Eject any documents on TOP sensor.	√			None	
		Performs driving test for rollers if no sensor in the ADF detects any paper.	√			E4	
6	5V and 3.3V fuse check		√			None (*1)	
	Motor fuse check		√	√		E4	
	SCSI fuse check		√			E8	
7	Light intensity check (gain adjustment for CCD amplifier)			√	√	E1	
				√	√	E2	
				√	√	E3	
8	Paper jam check			√		U1	

*1: In this case, scanner does not power on.

*2: Maintenance mode #1 does not detect multi feeding.

05	Nov. 20, 2008	K.Okada	T.Anzai	I.Fujioka	Refer to Revision Record on page 2.	TITLE fi-5530C/fi-5530C2 IMAGE SCANNER MAINTENANCE MANUAL	DRAW. No. P1PA03334-B30X/6	CUST.
04	July 7, 2008	K.Okada	T.Anzai	I.Fujioka	Refer to Revision Record on page 2.			
03	Feb.23, 2007	K.Okada	K.Okada	T.Anzai	Refer to Revision Record on page 2.			
Rev	DATE	DESIG.	CHECK	APPR.	DESCRIPTION	PFU LIMITED	PAGE	41/138
DESIG	Aug.19, 2005	K.Okada	CHECK	K.Okada	APPR. T.Anzai			

3-2 Temporary errors and Alarm detection algorithm

3-2-1. Temporary errors

Temporary errors occur during scanning operation and can be remedied by the operator. The temporary errors are displayed on the monitor of PC screen by the driver, or displayed on the operator panel of the scanner. The display and detection algorithm of the temporary errors are described below.

(1) Temporary error display sequence

When a temporary error occurs, the scanner displays it by the following sequence.

Function No. Display	Power LED	Description
	ON	Displays "U" and the error No. (0~9) alternately. Example) When error "U0" occurs, the scanner displays the following: "U" → "0"

When **Scan** or **Send to** button is pressed while the alarm is displayed, the scanner returns to the "Ready" display (Function number display).

(2) Temporary errors and detection algorithm

No.	Error display		Detection algorithm and action to recover						
	Scanner display	TWAIN display							
1	U1	"Paper jam detected"	<p>Paper jam</p> <p>This error is detected when one of the followings occurs:</p> <ol style="list-style-type: none"> 1) A document does not reach the TOP sensor while the scanner has transported the document about 250 mm to pick. (The scanner performs retry operation.) 2) The trailing edge of a document does not reach the TOP sensor after the scanner transports the document by the length (L) below. (The document may have slipped on the rollers) <table border="1"> <tr> <td>Scan condition</td> <td>Transported length (L) before jam</td> </tr> <tr> <td>ADF fixed size scanning</td> <td>Approximately 450 mm</td> </tr> <tr> <td>Long paper scanning</td> <td>1.2 times of the specified value</td> </tr> </table> <p>How to recover: Remove the jammed document and close the ADF. When the error frequently occurs, refer to Section 3-3-10.</p>	Scan condition	Transported length (L) before jam	ADF fixed size scanning	Approximately 450 mm	Long paper scanning	1.2 times of the specified value
Scan condition	Transported length (L) before jam								
ADF fixed size scanning	Approximately 450 mm								
Long paper scanning	1.2 times of the specified value								

05	Nov. 20, 2008	K.Okada	T.Anzai	I.Fujioka	Refer to Revision Record on page 2.	TITLE	fi-5530C/fi-5530C2 IMAGE SCANNER MAINTENANCE MANUAL		
04	July 7, 2008	K.Okada	T.Anzai	I.Fujioka	Refer to Revision Record on page 2.				
03	Feb.23, 2007	K.Okada	K.Okada	T.Anzai	Refer to Revision Record on page 2.				
						DRAW. No.	P1PA03334-B30X/6		CUST.
Rev	DATE	DESIG.	CHECK	APPR.	DESCRIPTION	PFU LIMITED		PAGE	42/138
DESIG	Aug.19, 2005	K.Okada	CHECK	K.Okada	APPR. T.Anzai				

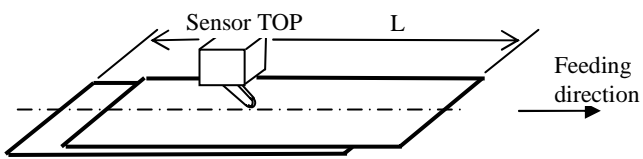
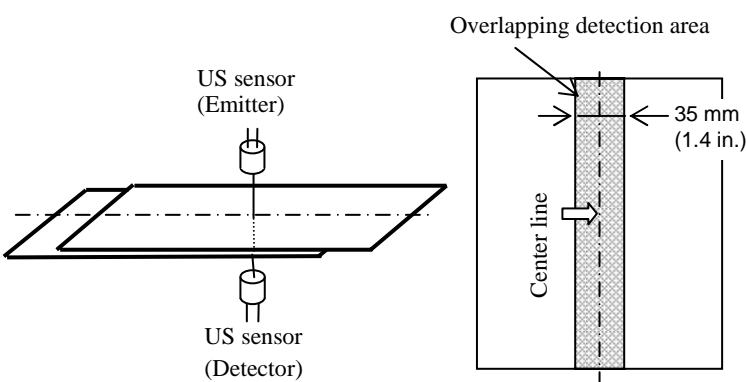
No.	Error display		Error detection algorithm and action to recover
	Scanner display	TWAIN display	
2	U2	"Multi feed error"	<p>Multi feed</p> <p>Two methods are used to detect this error, either/both of which can be selected by the driver setting. Both methods are set to OFF as default.</p> <p>1) Multi feed detection by paper length</p> <p>Using the Sensor TOP, the scanner measures the length of the document transported for the first time. The measured length is used as a standard length to be compared with the length of subsequent documents.</p> <p>The scanner detects a multi feed when the detected paper length is larger or smaller than the standard value (one out of $\pm 10\text{mm}$, $\pm 15\text{mm}$ or $\pm 20\text{mm}$, which is specified by the driver. If the subsequent document is shorter than the first one, it means the multi feed occurred at the first document.</p> <p>Immediately after a multi feed error is detected, the feeding operation stops.</p>  <p style="text-align: center;">$L - \text{paper length} > \pm 10, \pm 15, \pm 20$ (selectable)</p> <p>2) Multi feed detection by paper overlapping</p> <p>US sensor detects the overlapping of the document ultrasonic technology. The any punched holes are not allowed in the vertical center of 35 mm width area as shown below.</p>  <p>Note: When the overlapping check is specified, the papers which contact closely each other, such as glued paper or electro-statically charged paper, can result in the miss-detection of multi feed.</p> <p>How to recover: Remove the document and close the ADF. When the error frequently occurs, refer to Section 3-3-13.</p>

05	Nov. 20, 2008	K.Okada	T.Anzai	I.Fujioka	Refer to Revision Record on page 2.	TITLE fi-5530C/fi-5530C2 IMAGE SCANNER MAINTENANCE MANUAL	DRAW. No. P1PA03334-B30X/6	CUST.
04	July 7, 2008	K.Okada	T.Anzai	I.Fujioka	Refer to Revision Record on page 2.			
03	Feb.23, 2007	K.Okada	K.Okada	T.Anzai	Refer to Revision Record on page 2.			
Rev	DATE	DESIG.	CHECK	APPR.	DESCRIPTION	PFU LIMITED	PAGE	43/138
DESIG	Aug.19, 2005	K.Okada	CHECK	K.Okada	APPR. T.Anzai			

No.	Error display		Error detection algorithm and action to recover
	Scanner display	TWAIN display	
3	U6	“Ink cartridge is not installed in...”	<p>No print cartridge When the imprinter option is installed, no Print Cartridge mounted is detected during scanning. How to recover: Check if the Print Cartridge is mounted. Mount it if not.</p>
4	None	“No paper in ADF paper Chute”	<p>No papers on the Chute unit (ADF paper chute) This error occurs when the Sensor EM detects no paper loaded on the Chute unit (ADF paper chute) at the receipt of a Feed command. How to recover: Load documents on the Chute unit (ADF paper chute). When the error frequently occurs, replace Sensor EM by referring to Section 4-9-7.</p>
5	U4	“ADF cover opened”	<p>Cover open</p> <ul style="list-style-type: none"> - This error occurs when the Cover open sensor detects that the ADF is not closed at the receipt of a Feed command. - When the imprinter option is installed, the Cover open sensor detects that the Printing section is open. <p>How to recover: Close the ADF (or the Printing section). When the error frequently occurs, replace Base unit by referring to Section 4-8.</p>

05	Nov. 20, 2008	K.Okada	T.Anzai	I.Fujioka	Refer to Revision Record on page 2.	TITLE	fi-5530C/fi-5530C2 IMAGE SCANNER MAINTENANCE MANUAL		
04	July 7, 2008	K.Okada	T.Anzai	I.Fujioka	Refer to Revision Record on page 2.				
03	Feb.23, 2007	K.Okada	K.Okada	T.Anzai	Refer to Revision Record on page 2.				
						DRAW. No.	P1PA03334-B30X/6		CUST.
Rev	DATE	DESIG.	CHECK	APPR.	DESCRIPTION	PFU LIMITED		PAGE	44/138
DESIG	Aug.19, 2005	K.Okada	CHECK	K.Okada	APPR. T.Anzai				

3-2-2. Alarms

Alarms require the maintenance conducted by an authorized service person. The following table shows the display and detection algorithm for alarms. The alarms are displayed on a PC screen and/or on the operator panel (Function No. Display).

(1) Alarm displayed sequence

When an alarm occurs, the scanner displays the following on the operator panel:

Function No. Display	Power LED	Description
	ON	<p>Displays “E” and one of the alarm number (0 ~ 9, A ~ F) alternately.</p> <p>The example shown in the left column is the case of alarm “E0”. The display sequence is: “E” → “0”</p> <p>The interval of changing the display is approximately 1 second.</p>

When **Scan** or **Send to** button is pressed while the alarm is displayed, the scanner returns to the “Ready” display (Function number display).

(2) Alarms and their detection algorithm

No.	Error display		Error occurrence algorithm and action to recover	Related section
	Scanner display	TWAIN display		
1	E2	“Optical error”	<p>E2: Optical alarm (front) E3: Optical alarm (back) This alarm occurs if the gain adjustment of the CCD amplifier does not succeed at a READ command for the first document, or during scanning. (Refer to (3) in Section 2-2)</p>	3-3-14
2	E3	“Optical error”	<p>Probable causes:</p> <ul style="list-style-type: none"> - The optical system or white background is dirty. - Defective lamp or CCD. - Connector disconnected 	
3	E4	“Fuse for ADF motor blown”	<p>Fuse for ADF motor blown This alarm occurs immediately after the motor fuse is blown. For maintenance, the whole unit of the Control PCA needs replacing because the fuse is soldered to the Control PCA.</p> <p>Probable cause:</p> <ul style="list-style-type: none"> - A bit of metal material dropped on the Control PCA - Insulating material of motor cable damaged - Insulation corrupted inside the motor 	3-3-15
4	E5	None	(Reserved)	
5	E6 (Note1)	None	<p>Operator panel alarm When replacing the Panel PCA, the EEPROM data shall be moved to the Control PCA and the information that no data exists on the Panel PCA is written to the EEPROM of the Panel PCA. If the scanner detects that there is no EEPROM data in Panel PCA during initial processing at power-on, this alarm occurs.</p> <p>Probable causes: EEPROM data is not restored to Panel PCA</p>	3-3-17

05	Nov. 20, 2008	K.Okada	T.Anzai	I.Fujioka	Refer to Revision Record on page 2.	TITLE fi-5530C/fi-5530C2 IMAGE SCANNER MAINTENANCE MANUAL	DRAW. No. P1PA03334-B30X/6	CUST.
04	July 7, 2008	K.Okada	T.Anzai	I.Fujioka	Refer to Revision Record on page 2.			
03	Feb.23, 2007	K.Okada	K.Okada	T.Anzai	Refer to Revision Record on page 2.			
Rev	DATE	DESIG.	CHECK	APPR.	DESCRIPTION	PFU LIMITED	PAGE	45/138
DESIG	Aug.19, 2005	K.Okada	CHECK	K.Okada	APPR. T.Anzai			

No.	Error display		Error occurrence algorithm and action to recover	Related section
	Scanner display	TWAIN display		
6	E7 (Note1)	“EEPROM error”	EEPROM error This alarm is detected by comparing data in EEPROM during initial processing immediately after power-on. Probable causes: Damaged EEPROM in Panel PCA.	3-3-18
7	E8 (Note1)	None	SCSI fuse blown This alarm is detected during initial processing immediately after power-on. Probable causes: - Defective SCSI cable - Other SCSI device malfunction	3-3-19
8	E9 (Note1)	None	Image memory alarm This alarm is detected by checking read/write and bus only while initial processing immediately after power-on. Probable causes: - Defective memory - Defective Control PCA	3-3-20
9	EA	None	Imprinter error The alarm is detected when, - The nozzle actuator of Print cartridge burn. - The data communication between scanner and imprinter failed. - The sensor or Motor in imprinter is out of control. Probable cause: - Defective Print cartridge - Defective Control PCA of Imprinter or Scanner - Defective sensor or motor in imprinter	3-3-21
10	Ec	None	RAM alarm This alarm is detected by checking read/write and bus. Probable causes: - Defective Control PCA	3-3-22
11	Ed	None	Interface Control alarm This alarm is detected by checking read/write and bus. Probable causes: - Defective Control PCA	3-3-23
12	EF	Background changeover failure unit	Background changeover unit failure This is detected in initial checking at power on. Probable cause: - Defective Control PCA - Insulation material damage of BW motor cable or the damage of the wire in the motor.	3-3-24

Note 1) The alarm E6 ~ E9 is displayed 3 times before “0” during the initial processing after power-on. When more than 2 of these errors occur simultaneously, they are displayed in the order of the priority described below:

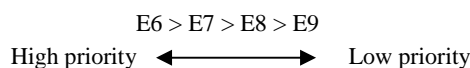

The scanner can perform scan operation even if these alarms occur, but it may not be the same operation as usual. For instance, when EEPROM is damaged, the document is scanned by default settings, which means the settings of magnification, offset and white level may not be optimum for the document to be scanned. When image memory is damaged, irregular image may appear which can be easily detected by visual check.

05	Nov. 20, 2008	K.Okada	T.Anzai	I.Fujioka	Refer to Revision Record on page 2.	TITLE fi-5530C/fi-5530C2 IMAGE SCANNER MAINTENANCE MANUAL	DRAW. No. P1PA03334-B30X/6	CUST.
04	July 7, 2008	K.Okada	T.Anzai	I.Fujioka	Refer to Revision Record on page 2.			
03	Feb.23, 2007	K.Okada	K.Okada	T.Anzai	Refer to Revision Record on page 2.			
Rev	DATE	DESIG.	CHECK	APPR.	DESCRIPTION	PFU LIMITED	PAGE	46/138
DESIG	Aug.19, 2005	K.Okada	CHECK	K.Okada	APPR. T.Anzai			

No	Error display		Error occurrence algorithm and action to recover	Related section
	Scanner display	TWAIN display		
13	None	“Temporary shortage of scanned data”	This alarm is detected during communication between PCA and Scanner. Probable causes: - Miss-communication between PC and scanner - Defective Control PCA	-
14	None	“Invalid cammand”		-
15	None	“Invalid CDB field”		-
16	None	“Unsupported logical unit (LUN)”		-
17	None	“Invalid dfield parameter list”		-
18	None	“Command sequence error”		-
19	None	“Wrong windows combination”		-
20	None	“Unit Attention”		-
21	None	“Message error”	This alarm is detected by driver. Probable causes: - Connection between PC and scanner is not correct. (Cable connection etc.) - Does not work with SCSI Card. - Miss-communication between PC and scanner - Defective Control PCA	-
22	None	Select/Reselect Failure”		-
23	None	“SCSI parity error”		-
24	None	“Initiator Detected Error Message Received”		-
25	None	“Overlapped Command Attempted”		-
26	None	“Image transfer error”		-

05	Nov. 20, 2008	K.Okada	T.Anzai	I.Fujioka	Refer to Revision Record on page 2.	TITLE	fi-5530C/fi-5530C2 IMAGE SCANNER MAINTENANCE MANUAL		
04	July 7, 2008	K.Okada	T.Anzai	I.Fujioka	Refer to Revision Record on page 2.				
03	Feb.23, 2007	K.Okada	K.Okada	T.Anzai	Refer to Revision Record on page 2.				
						DRAW. No.	P1PA03334-B30X/6		CUST.
Rev	DATE	DESIG.	CHECK	APPR.	DESCRIPTION	PFU LIMITED		PAGE	47/138
DESIG	Aug.19, 2005	K.Okada	CHECK	K.Okada	APPR. T.Anzai				

3-3 Troubleshooting

When a temporary error or an alarm occurs, find the troubleshooting procedure from the list in this section and go to the related section for maintenance. Before starting the troubleshooting, get the following information from your customer to understand whether the error is scanner-related or system-related.

- Is the scanner operated correctly?
- Are the fault symptoms reproducible or persistent?
(Check if the target scanner causes the same error under other systems.)

NOTICE

The troubleshooting should be conducted from item number 1 to the last item number in a table.
Continue the troubleshooting until the error is removed.

Following lists the case of troubleshooting described later in this section.

Error category	Error description	Related section	Remarks
Device	Scanner does not turn ON. (Display of the operator panel goes out)	3-3-1	
	Scanning does not start.	3-3-2	
	Scanned image is distorted.	3-3-3	
Image	Resolution or gradation of scanned image is unsatisfactory.	3-3-4	
	Too much jitter on scanned image with ADF scanning	3-3-5	
	Scanned image is misaligned with ADF scanning	3-3-6	
	Scan magnification factor abnormal with ADF scanning	3-3-7	
	Vertical streaks appear in scanned image	3-3-8	
	When calibrating color of scanned image	3-3-9	
Temporary error	Frequent "U1: paper jam error"	3-3-10	
	Error detection of "No paper on the Chute unit"	3-3-11	
	Error detection of "U4: ADF cover open"	3-3-12	
	Frequent "U2: multi feed error"	3-3-13	
Alarm	"E2 or E3: Optical alarm"	3-3-14	
	"E4: Motor fuse blown"	3-3-15	
	(Reserved)	(3-3-16)	
	"E6: Operator panel alarm"	3-3-17	
	"E7: EEPROM alarm"	3-3-18	
	"E8: SCSI fuse blown"	3-3-19	
	"E9: Image memory alarm"	3-3-20	
	"EA: Imprinter error"	3-3-21	
	"Ec: RAM alarm"	3-3-22	
	"Ed: SPC alarm"	3-3-23	
	"EF: Background changeover alarm"	3-3-24	

05	Nov. 20, 2008	K.Okada	T.Anzai	I.Fujioka	Refer to Revision Record on page 2.	TITLE fi-5530C/fi-5530C2 IMAGE SCANNER MAINTENANCE MANUAL	DRAW. No. P1PA03334-B30X/6	CUST.
04	July 7, 2008	K.Okada	T.Anzai	I.Fujioka	Refer to Revision Record on page 2.			
03	Feb.23, 2007	K.Okada	K.Okada	T.Anzai	Refer to Revision Record on page 2.			
Rev	DATE	DESIG.	CHECK	APPR.	DESCRIPTION	PFU LIMITED	PAGE	48/138
DESIG	Aug.19, 2005	K.Okada	CHECK	K.Okada	APPR. T.Anzai			

3-3-1. Scanner does not turn ON (No display on the operator panel)

Table 3-3-1

Item No.	Check items	How/where to check
1	Does the same symptom occur after turning OFF and ON the scanner?	Press power button of the scanner for more than 2 seconds to turn it OFF, and after more than 2 seconds elapse, press the power button to turn the scanner ON.
2	Are the AC cable and AC adapter correctly connected?	---
3	Replace the AC cable and AC adapter and see if the error is resolved.	---
4	Replace Panel PCA and see if the error is resolved.	Refer to Section 4-9-1 .
5	Replace Control PCA and see if the error is resolved.	Refer to Section 4-11 .

3-3-2. Scanning does not start

Table 3-3-2

Item No.	Check items	How/where to check
1	Does the same symptom appear when turning the scanner ON again?	Press power button of the scanner for more than 2 seconds to turn it OFF, and after more than 2 seconds elapse, press the power button to turn the scanner ON.
2	Check the items listed in the right column.	<ul style="list-style-type: none"> • Are the AC cable and AC adapter correctly connected? • Is there documents loaded on Chute unit (ADF paper chute)? • Is ADF cover completely closed? • Is interface cable correctly connected? • Is SCSI ID correctly set? • If any temporary error or alarm is indicated, follow the corresponding troubleshooting.

3-3-3. Scanned image is distorted

Due to loose connection of connectors, cut wire in cables or defective parts, scanned image may have regular or random pattern distortion on it.

Table 3-3-3

Item No.	Check items	How/where to check
1	Check the items listed in the right column.	<ul style="list-style-type: none"> • Is interface cable correctly connected? • If any temporary error or alarm is indicated, follow the corresponding troubleshooting.
2	Are the cables between Control PCA and Optical unit damaged? Or are the connectors connected correctly?	ADF front scanning: See Section 4-10-6 for checking. ADF back scanning: See Section 4-9-3 for checking.
3	Replace Optical unit and see if the error is resolved.	ADF front scanning: See Section 4-10-6 for replacement. ADF back scanning: See Section 4-9-3 for replacement.
4	Replace Control PCA and see if the error is resolved.	Refer to Section 4-11 .

05	Nov. 20, 2008	K.Okada	T.Anzai	IFujioka	Refer to Revision Record on page 2.	TITLE fi-5530C/fi-5530C2 IMAGE SCANNER MAINTENANCE MANUAL	DRAW. No. P1PA03334-B30X/6	CUST.
04	July 7, 2008	K.Okada	T.Anzai	IFujioka	Refer to Revision Record on page 2.			
03	Feb.23, 2007	K.Okada	K.Okada	T.Anzai	Refer to Revision Record on page 2.			
Rev	DATE	DESIG.	CHECK	APPR.	DESCRIPTION	PFU LIMITED	PAGE	49/138
DESIG	Aug.19, 2005	K.Okada	CHECK	K.Okada	APPR. T.Anzai			

3-3-4. Resolution or gradation of scanned image is unsatisfactory

Table 3-3-4

Item No.	Check items	How/where to check
1	Check the items listed in the right column.	<ul style="list-style-type: none"> Does the document satisfy the paper specifications described in Section 1-2? Are the scan settings (resolution or density) correctly specified for the application software used? Is interface cable correctly connected? If any temporary error or alarm is indicated, follow the corresponding troubleshooting.
2	Clean feed rollers and plastic roller and check whether the error is resolved.	Refer to Section 1-7-1 .
3	Is the optical unit or lamp dirty? Are the cables damaged? Or are the connectors connected correctly?	ADF front scanning: See Section 4-10-6 for cleaning and checking. ADF back scanning: See Section 4-9-3 for cleaning and checking.
4	Replace Optical unit and see if the error is resolved.	ADF front scanning: See Section 4-10-6 for replacement. ADF back scanning: See Section 4-9-3 for replacement.
5	Replace Control PCA and see if the error is resolved.	Refer to Section 4-11 .

05	Nov. 20, 2008	K.Okada	T.Anzai	I.Fujioka	Refer to Revision Record on page 2.	TITLE	fi-5530C/fi-5530C2 IMAGE SCANNER MAINTENANCE MANUAL		
04	July 7, 2008	K.Okada	T.Anzai	I.Fujioka	Refer to Revision Record on page 2.				
03	Feb.23, 2007	K.Okada	K.Okada	T.Anzai	Refer to Revision Record on page 2.				
						DRAW. No.	P1PA03334-B30X/6		CUST.
Rev	DATE	DESIG.	CHECK	APPR.	DESCRIPTION	PFU LIMITED		PAGE	50/138
DESIG	Aug.19, 2005	K.Okada	CHECK	K.Okada	APPR. T.Anzai				

3-3-5. Too much jitter on scanned image with ADF scanning

The following shows the sample of scanned image when “Jitter” error occurs. This error occurs when the ADF feed roller does not transport the document smoothly.

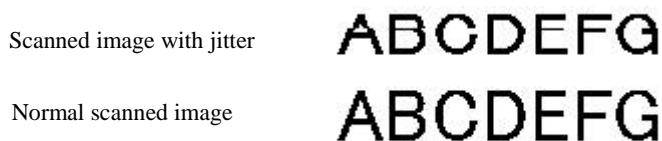

Table 3-3-5

Item No.	Check items	How/where to check
1	Does the document satisfy the paper specification?	Refer to Section 1-2 for the paper specification.
2	Clean feed rollers, eject rollers and plastic rollers and see if the error is resolved.	Refer to Section 1-7-1 .
3	Replace Pick roller and Pad ASSY and see if the error is resolved.	Check the consumable counter from the TWAIN driver screen or in Test mode #5 (Section 5-1-6). When the counter exceeds the values shown in Section 1-8-1 , replace Pick roller or Pad ASSY.
4	Check if the belt tension is appropriate and if the Guide A ASY, Guide P ASY, Upper cover, Rear cover is installed correctly.	Refer to Section 4-9-6 for belt tension. Refer to Section 4-7-6 for Guide A ASY, Section 4-10-1 for Guide P ASY (Sheet guide), Section 4-7-4 for Rear cover and Section 4-7-5 for Upper cover.
5	Are the cables between Control PCA and ADF motor damaged? Or are the connectors connected correctly? Check if the belt tension is appropriate and if the Guide A ASY, Guide P ASY, Cover, Top cover are installed correctly.	Refer to Section 4-9-6 to confirm.
6	Replace Upper unit and see if the error is resolved.	Refer to Section 4-8 .
7	Replace Base unit and see if the error is resolved.	Refer to Section 4-8 .

3-3-6. Scanned image is misaligned with ADF scanning

Table 3-3-6

Item No.	Check items	How/where to check
1	Check the items listed in the right column.	- Does the document satisfy the paper specifications described in Section 1-2 ? - Are the scan settings (document size etc.) correct for the application software used?
2	Clean feed rollers, eject rollers and plastic rollers and see if the error is resolved.	Refer to Section 1-7-1 .
3	Adjust the offset by Maintenance mode.	Refer to Section 5-1-4 .
4	Is Optical unit installed correctly?	ADF front: Refer to Section 4-10-6 . ADF back: Refer to Section 4-9-3 .
5	If backside image is problem, confirm that a plastic washer is correctly attached between the plates.	Refer to Section 4-8 .
6	When the backside image is misaligned, replace Upper unit and see whether the error is resolved.	Refer to Section 4-8 .
7	When the front side image is misaligned, replace Base unit and see whether the error is resolved.	Refer to Section 4-8 .

05	Nov. 20, 2008	K.Okada	T.Anzai	I.Fujioka	Refer to Revision Record on page 2.	TITLE fi-5530C/fi-5530C2 IMAGE SCANNER MAINTENANCE MANUAL	DRAW. No. P1PA03334-B30X/6	CUST.
04	July 7, 2008	K.Okada	T.Anzai	I.Fujioka	Refer to Revision Record on page 2.			
03	Feb.23, 2007	K.Okada	K.Okada	T.Anzai	Refer to Revision Record on page 2.			
Rev	DATE	DESIG.	CHECK	APPR.	DESCRIPTION	PFU LIMITED	PAGE	51/138
DESIG	Aug.19, 2005	K.Okada	CHECK	K.Okada	APPR. T.Anzai			

3-3-7. Scan magnification factor abnormal with ADF scanning

Table 3-3-7

Item No.	Check items	How/where to check
1	Check the items listed in the right column.	Are the scan settings (resolution etc.) correct for the application software used?
2	Adjust the magnification in Maintenance mode.	Refer to Section 5-1-3 . When main scanning magnification is abnormal: Go to Item No.3 When sub scanning magnification is abnormal: Go to Item No.7
3	Clean feed rollers, eject rollers and plastic rollers and see if the error is resolved.	Refer to Section 1-7-1 .
4	Does any foreign object get inside of Upper unit and disturb feeding operation by feed rollers?	Open the ADF and check Upper unit gear.
5	Is LF motor belt loose?	Refer to a note in Section 4-9-6 .
6	Replace LF motor and see whether the error is resolved.	Refer to Section 4-9-6 .
7	Is Optical unit installed correctly?	ADF (front) scanning: Refer to Section 4-10-6 .
8	Replace Optical unit and see whether the error is resolved.	ADF (back) scanning: Refer to Section 4-9-3 .

3-3-8. Vertical streaks appear in scanned image

Table 3-3-8

Item No.	Check items	How/where to check
1	Check the items listed in the right column.	Is interface cable correctly connected?
2	Clean glass in the ADF and see if the error is resolved.	Refer to Section 1-7-1 .
3	When the error occurs on ADF front, clean inside of the glass of Upper unit. When the error occurs on ADF back, clean inside of the glass of Dust cover ASY.	ADF front: Refer to Section 4-3-2 for cleaning the glass of Dust cover. ADF back: Refer to Section 4-3-4 to remove Optical unit and clean the glass of Upper unit.
4	Is Optical unit dirty? Are cables damaged? Are connectors connected correctly?	ADF front: Refer to Section 4-3-1 for cleaning and checking. ADF back: Refer to Section 4-3-3 for cleaning and checking.
5	Replace Optical unit and see if the error is resolved.	ADF front: Refer to Section 4-10-6 for replacement procedure. ADF back: Refer to Section 4-9-3 for replacement procedure.
6	Replace Control PCA and see if the error is resolved.	Refer to Section 4-11 .

05	Nov. 20, 2008	K.Okada	T.Anzai	I.Fujioka	Refer to Revision Record on page 2.	TITLE fi-5530C/fi-5530C2 IMAGE SCANNER MAINTENANCE MANUAL	DRAW. No. P1PA03334-B30X/6	CUST.
04	July 7, 2008	K.Okada	T.Anzai	I.Fujioka	Refer to Revision Record on page 2.			
03	Feb.23, 2007	K.Okada	K.Okada	T.Anzai	Refer to Revision Record on page 2.			
Rev	DATE	DESIG.	CHECK	APPR.	DESCRIPTION	PFU LIMITED	PAGE	52/138
DESIG	Aug.19, 2005	K.Okada	CHECK	K.Okada	APPR. T.Anzai			

3-3-9. When calibrating white of scanned image

Table 3-3-9

Item No.	Check items	How/where to check
1	Check the items listed in the right column.	- Are the scan settings (density or color number) correct for the application software used? - Is the sheet guide (Guide P ASSY, White part) in the ADF dirty?
2	Conduct the white adjustment by Maintenance mode.	Refer to Section 5-1-5 .

3-3-10. Frequent “U1: paper jam error”

Table 3-3-10

Item No.	Check items	How/where to check
1	Do the documents satisfy paper specification?	Refer to Section 1-2 for paper specification
2	Have the documents been jogged?	<ul style="list-style-type: none"> Align the edge of documents for stable paper feeding. Remove documents with crease or dog-ear. Scanning different width of documents may cause skew and result in paper jam.
3	Is Paper thickness switch set to “Thin” while document thickness is more than 52 g/m ² .	Set the switch to “Normal” position. Refer to Section 1-1 for Paper thickness switch.
4	Is Paper thickness switch set to “Normal” while document thickness is less than 52 g/m ² .	Set the switch to “Thin” position. However, this does not mean that feeding of thin paper less than 52 g/m ² is assured. Refer to Section 1-1 for Paper thickness switch.
5	Clean feed rollers, eject rollers and plastic rollers and see if the error is resolved.	Refer to Section 1-7-1 .
6	Replace Pick roller and Pad ASSY and see if the error is resolved.	Check the consumable counter from the TWAIN driver screen or from the built-in Maintenance mode (Section 5-1-6). When the counter exceeds the values shown in Section 1-8-1 , replace Pick roller or Pad ASSY.
7	Check the performance of Sensor PICK and Sensor TOP.	Refer to Section 5-1-2 for checking.
8	Is Cover open sensor malfunctioning?	Refer to Section 5-1-2 for checking.

3-3-11. Error detection of “No paper on the Chute unit”

Table 3-3-11

Item No.	Check items	How/where to check
1	Does the same symptom occur after turning OFF and ON the scanner?	Press power button of the scanner for more than 2 seconds to turn it OFF, and after more than 2 seconds elapse, press the power button to turn the scanner ON.
2	Is there a slip of paper left near Hopper empty sensor?	Open the ADF and check inside visually.
3	Check the performance of Hopper empty sensor.	Conduct Maintenance mode (Section 5-1-2) to see if the sensor works properly. If the error still occurs, confirm that the cable is correctly connected then replace the sensor. (Refer to Section 4-9-7 .)

05	Nov. 20, 2008	K.Okada	T.Anzai	I.Fujioka	Refer to Revision Record on page 2.	TITLE	fi-5530C/fi-5530C2 IMAGE SCANNER MAINTENANCE MANUAL		
04	July 7, 2008	K.Okada	T.Anzai	I.Fujioka	Refer to Revision Record on page 2.				
03	Feb.23, 2007	K.Okada	K.Okada	T.Anzai	Refer to Revision Record on page 2.				
						DRAW. No.	P1PA03334-B30X/6		CUST.
Rev	DATE	DESIG.	CHECK	APPR.	DESCRIPTION	PFU LIMITED		PAGE	53/138
DESIG	Aug.19, 2005	K.Okada	CHECK	K.Okada	APPR. T.Anzai				

3-3-12. Error detection of “U4: ADF cover open”

Table 3-3-12

Item No.	Check items	How/where to check
1	Does the same symptom occur after turning OFF and ON the scanner?	Press power button of the scanner for more than 2 seconds to turn it OFF, and after more than 2 seconds elapse, press the power button to turn the scanner ON.
2	Is there a slip of paper left near Cover open sensor?	Open the ADF and check inside visually.
3	Check the performance of Cover open sensor	Conduct Maintenance mode (Section 5-1-2) to see if the sensor works properly. If the error still occurs, confirm that the cable is correctly connected.

3-3-13. Frequent “U2: multi feed error”

Table 3-3-13

Item No.	Check items	How/where to check
1	Do the documents satisfy paper specification?	Refer to Section 1-2 for paper specification, paying attention to the following points: <ul style="list-style-type: none"> Is multi feed error detected by paper length when scanning documents with different length? Is there perforation in the center of documents?
2	Clean ADF unit.	Refer to Section 1-7-1 for cleaning cycle and method. Clean Pick roller, Pad ASSY and around US sensor with care.
3	Replace Pick roller and Pad ASSY and see if the error is resolved.	Check the consumable counter from the TWAIN driver screen or from the built-in Maintenance mode (Section 5-1-6). When the counter exceeds the values shown in Section 1-8-1 , replace Pick roller or Pad ASSY.
4	Check the performance of US sensor.	Conduct Maintenance mode (Section 5-1-2) to see if the sensor works properly. If the error still occurs, confirm that the cable is correctly connected then replace the sensor. (Refer to Section 4-9-5, 4-10-1)

05	Nov. 20, 2008	K.Okada	T.Anzai	I.Fujioka	Refer to Revision Record on page 2.	TITLE fi-5530C/fi-5530C2 IMAGE SCANNER MAINTENANCE MANUAL	DRAW. No. P1PA03334-B30X/6	CUST.
04	July 7, 2008	K.Okada	T.Anzai	I.Fujioka	Refer to Revision Record on page 2.			
03	Feb.23, 2007	K.Okada	K.Okada	T.Anzai	Refer to Revision Record on page 2.			
Rev	DATE	DESIG.	CHECK	APPR.	DESCRIPTION	PFU LIMITED	PAGE	54/138
DESIG	Aug.19, 2005	K.Okada	CHECK	K.Okada	APPR. T.Anzai			

3-3-14. "E2 or E3: Optical alarm"

E2: Relates front side image, or lower optical unit trouble.

E3: Relates backside image, or Upper optical unit trouble.

Table 3-3-14

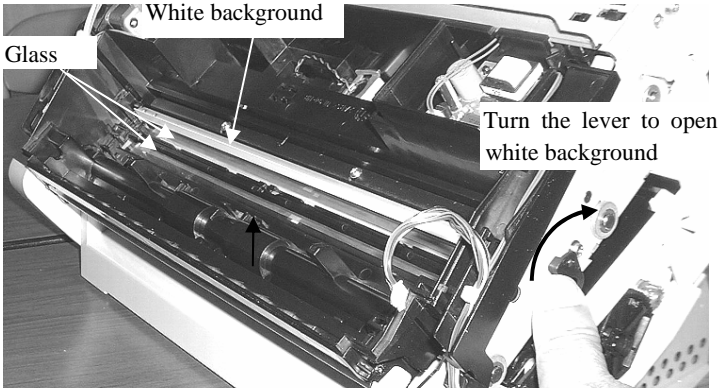
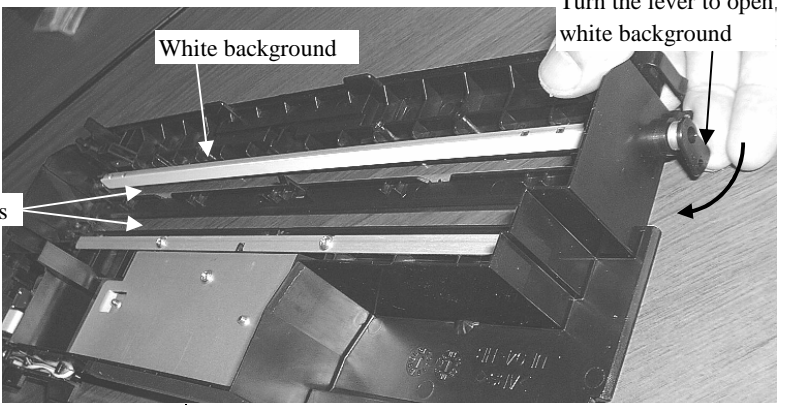
Item No.	Check items	How/where to check
1	Does the same symptom occur after turning OFF and ON the scanner?	Press power button of the scanner for more than 2 seconds to turn it OFF, and after more than 2 seconds elapse, press the power button to turn the scanner ON.
2	Is sheet guide (Guide P ASSY, white part) in the reading position dirty?	Open the ADF and clean the sheet guide (Guide P ASSY, white part) and the glass. (Refer to Section 1-7-1)
3	Is the lamp ON? Are the cables damaged? Are the connectors connected correctly?	Disconnect SCSI cable and turn the scanner ON. Open the ADF and press Cover open sensor to see if the lamp lights. If not, the error is caused by the defective lamp.
4	Is the optical unit dirty? Are the cables damaged? Are the connectors connected correctly?	E2 (ADF front): Refer to Section 4-3-1 for cleaning and checking. E2 (ADF back): Refer to Section 4-3-3 for cleaning and checking.
5	Confirm if the glasses or white backgrounds in the paper guides are dirty or not.	<p>If upper glass or white background are dirty: Remove Lamp SR by referring Section 4-9-4, and clean glass and white background.</p>  <p>If lower glass or white background are dirty: Remove Lamp SR by referring Section 4-10-5, and clean glass and white background.</p> 
6	Replace Optical unit and see if the error is resolved.	E2 (ADF front): Refer to Section 4-10-6 . E3 (ADF back): Refer to Section 4-9-3 .

05	Nov. 20, 2008	K.Okada	T.Anzai	I.Fujioka	Refer to Revision Record on page 2.	TITLE fi-5530C/fi-5530C2 IMAGE SCANNER MAINTENANCE MANUAL	DRAW. No. P1PA03334-B30X/6	CUST.
04	July 7, 2008	K.Okada	T.Anzai	I.Fujioka	Refer to Revision Record on page 2.			
03	Feb.23, 2007	K.Okada	K.Okada	T.Anzai	Refer to Revision Record on page 2.			
Rev	DATE	DESIG.	CHECK	APPR.	DESCRIPTION	PFU LIMITED	PAGE	55/138
DESIG	Aug.19, 2005	K.Okada	CHECK	K.Okada	APPR. T.Anzai			

3-3-15. “E4: Motor fuse blown”

Table 3-3-15

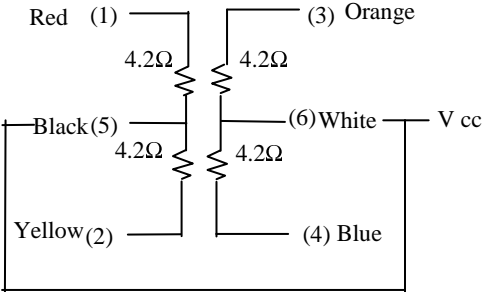
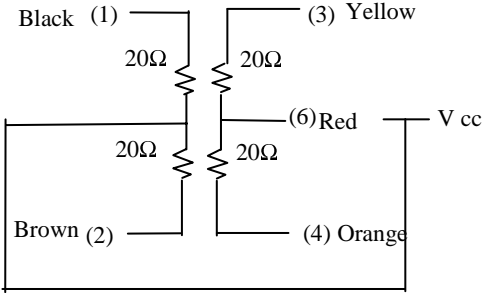
Item No.	Check items	How/where to check
1	Does the same symptom occur after turning OFF and ON the scanner?	Press power button of the scanner for more than 2 seconds to turn it OFF, and after more than 2 seconds elapse, press the power button to turn the scanner ON.
2	Does any foreign object get inside the Control PCA?	Take out the Control PCA for checking (Refer to Section 4-7-3).
3	Are the cables between Control PCA and LF motor, PICK motor or BW motor damaged? Or are the connectors connected correctly?	Refer to Section 4-9-6 for checking LF motor cable. Refer to Section 4-10-7 for checking PICK motor cable. Refer to Section 4-10-8 for checking BW motor cable.
4	Are coil resistances of LF motor, PICK motor, or BW motor normal?	<p>Remove PCB unit by referring Section 4-7-3, and check the coil resistances between the following pins of connector.</p> <p>For LF motor and PICK motor: Resistance (5) - (1), (5) - (2): $4.2 \Omega \pm 10\%$ Resistance (6) - (3), (6) - (4): $4.2 \Omega \pm 10\%$ Resistance (1) - (2), (3) - (4): Approximately 8.4Ω Other match: $\infty \Omega$</p>  <p>For BW motor: Resistance (5) - (1), (5) - (2): $20 \Omega \pm 10\%$ Resistance (5) - (3), (5) - (4): $20 \Omega \pm 10\%$ Resistance (1) - (2), (1) - (3): Approximately 40Ω Resistance (1) - (4), (2) - (3): Approximately 40Ω Resistance (2) - (4), (3) - (4): Approximately 40Ω</p>  <p>Replace the motor, if the resistance does not meet the above.</p>
5	Replace Control PCA and see if the error is resolved.	Refer to Section 4-11 for replacement.

05	Nov. 20, 2008	K.Okada	T.Anzai	I.Fujioka	Refer to Revision Record on page 2.	TITLE	fi-5530C/fi-5530C2 IMAGE SCANNER MAINTENANCE MANUAL		
04	July 7, 2008	K.Okada	T.Anzai	I.Fujioka	Refer to Revision Record on page 2.				
03	Feb. 23, 2007	K.Okada	K.Okada	T.Anzai	Refer to Revision Record on page 2.				
						DRAW. No.	P1PA03334-B30X/6		CUST.
Rev	DATE	DESIG.	CHECK	APPR.	DESCRIPTION	PFU LIMITED		PAGE	56/138
DESIG	Aug. 19, 2005	K.Okada	CHECK	K.Okada	APPR. T.Anzai				

3-3-16. (Reserved)**3-3-17. “E6: Operator panel alarm”**

Table 3-3-17

Item No.	Check items	How/where to check
1	Does the same symptom occur after turning OFF and ON the scanner?	Press power button of the scanner for more than 2 seconds to turn it OFF, and after more than 2 seconds elapse, press the power button to turn the scanner ON.
2	It seems the installed Panel PCA has been used in other scanner before and it may be faulty one. Replace it with the new Panel PCA.	If the EEPROM data is saved, replace the Panel PCA with new one, and run Maintenance mode #7 by referring to Section 5-1-8 .

3-3-18. “E7: EEPROM alarm”

Table 3-3-18

Item No.	Check items	How/where to check
1	Does the same symptom occur after turning OFF and ON the scanner?	Press power button of the scanner for more than 2 seconds to turn it OFF, and after more than 2 seconds elapse, press the power button to turn the scanner ON.
2	Replace the Panel PCA and see if the error is resolved.	Refer to Section 4-9-1 for replacement.
3	Replace the Control PCA and see if the error is resolved	Refer to Section 4-11 for replacement.

3-3-19. “E8: SCSI fuse blown”

Table 3-3-19

Item No.	Check items	How/where to check
1	Does the same symptom occur after turning OFF and ON the scanner?	Press power button of the scanner for more than 2 seconds to turn it OFF, and after more than 2 seconds elapse, press the power button to turn the scanner ON.
2	Check if the SCSI cable or other SCSI devices connected to the scanner cause this error.	The scanner can work even after this error occurs. Go to item 3 if you want to remove this error.
3	Replace the Control PCA and see if the error is resolved	Refer to Section 4-11 for replacement.

05	Nov. 20, 2008	K.Okada	T.Anzai	I.Fujioka	Refer to Revision Record on page 2.	TITLE fi-5530C/fi-5530C2 IMAGE SCANNER MAINTENANCE MANUAL	DRAW. No. P1PA03334-B30X/6	CUST.
04	July 7, 2008	K.Okada	T.Anzai	I.Fujioka	Refer to Revision Record on page 2.			
03	Feb.23, 2007	K.Okada	K.Okada	T.Anzai	Refer to Revision Record on page 2.			
Rev	DATE	DESIG.	CHECK	APPR.	DESCRIPTION	PFU LIMITED		PAGE
DESIG	Aug.19, 2005	K.Okada	CHECK	K.Okada	APPR. T.Anzai			57/138

3-3-20. “E9: Image memory alarm”

Table 3-3-20

Item No.	Check items	How/where to check
1	Does the same symptom occur after turning OFF and ON the scanner?	Press power button of the scanner for more than 2 seconds to turn it OFF, and after more than 2 seconds elapse, press the power button to turn the scanner ON.
2	Replace the Control PCA and see if the error is resolved.	Refer to Section 4-11 for replacement.

3-3-21. “EA: Imprinter error”

Table 3-3-21

Item No.	Check items	How/where to check
1	Is Print cartridge attached correctly?	Attach the cartridge correctly. (Refer to Section 2-3 in Imprinter maintenance manual.)
2	Replace the Print cartridge. Is the alarm resolved?	Refer to Section 3-3 in the Imprinter maintenance manual.
3	Is the cable from imprinter (EXT cable) connected correctly?	Refer to Section 2-2 in the Imprinter maintenance manual.
4	Does the same symptom occur after turning OFF and ON the scanner?	Press power button of the scanner for more than 2 seconds to turn it OFF, and after more than 2 seconds elapse, press the power button to turn the scanner ON.
5	Replace the Control PCA. Is the error removed after replacing Control PCA?	Refer to Section 5-4 in the Imprinter maintenance manual.

3-3-22. “Ec: RAM alarm”

Table 3-3-22

Item No.	Check items	How/where to check
1	Does the same symptom occur after turning OFF and ON the scanner?	Press power button of the scanner for more than 2 seconds to turn it OFF, and after more than 2 seconds elapse, press the power button to turn the scanner ON.
2	Replace the Control PCA and see if the error is resolved.	Refer to Section 4-11 for replacement.

3-3-23. “Ed: SPC alarm”

Table 3-3-23

Item No.	Check items	How/where to check
1	Does the same symptom occur after turning OFF and ON the scanner?	Press power button of the scanner for more than 2 seconds to turn it OFF, and after more than 2 seconds elapse, press the power button to turn the scanner ON.
2	Replace the Control PCA and see if the error is resolved.	Refer to Section 4-11 for replacement.

05	Nov. 20, 2008	K.Okada	T.Anzai	I.Fujioka	Refer to Revision Record on page 2.	TITLE	fi-5530C/fi-5530C2 IMAGE SCANNER MAINTENANCE MANUAL		
04	July 7, 2008	K.Okada	T.Anzai	I.Fujioka	Refer to Revision Record on page 2.				
03	Feb.23, 2007	K.Okada	K.Okada	T.Anzai	Refer to Revision Record on page 2.				
						DRAW. No.	P1PA03334-B30X/6	CUST.	
Rev	DATE	DESIG.	CHECK	APPR.	DESCRIPTION	PFU LIMITED		PAGE	58/138
DESIG	Aug.19, 2005	K.Okada	CHECK	K.Okada	APPR. T.Anzai				

3-3-24. "EF: Background changeover alarm"

Table 3-3-24

Item No.	Check items	How/where to check
1	Does the same symptom occur after turning OFF and ON the scanner?	Press power button of the scanner for more than 2 seconds to turn it OFF, and after more than 2 seconds elapse, press the power button to turn the scanner ON.
2	Are the cables between Control PCA and the BW motor damaged? Or are the connectors connected correctly?	Refer to Section 4-10-8 for checking the cable.
3	Confirm if CCD cable F or B are not damaged and their connectors are correctly connected.	Refer to Section 4-9-3 for CCD cable B. Refer to Section 4-10-6 for CCD cable F.
4	Replace the Control PCA and see if the error is resolved.	Refer to Section 4-11 for its replacement.
5	Replace Optical unit and see if the error is resolved.	Refer to Section 4-10-6 for lower Optical unit replacement. Refer to Section 4-9-3 for upper Optical unit replacement.

05	Nov. 20, 2008	K.Okada	T.Anzai	I.Fujioka	Refer to Revision Record on page 2.	TITLE	fi-5530C/fi-5530C2 IMAGE SCANNER MAINTENANCE MANUAL		
04	July 7, 2008	K.Okada	T.Anzai	I.Fujioka	Refer to Revision Record on page 2.				
03	Feb.23, 2007	K.Okada	K.Okada	T.Anzai	Refer to Revision Record on page 2.				
						DRAW. No.	P1PA03334-B30X/6		CUST.
Rev	DATE	DESIG.	CHECK	APPR.	DESCRIPTION	PFU LIMITED		PAGE	59/138
DESIG	Aug.19, 2005	K.Okada	CHECK	K.Okada	APPR. T.Anzai				

Chapter 4 DISASSEMBLY / ASSEMBLY

4-1. Safety

Please read this page carefully before performing disassembly or assembly.



Warning

Electric shock

When the power supply cord being connected to AC outlet, the each electric diagram is in active because it supplies AC power source.

Before disassembling and assembling, turn the power button off, and unplug the AC power source from the outlet.

If you do not this, the electric shock may results on you.



CAUTION

Injury

Be careful not to catch your fingers, hair, clothes or accessories in the moving part. It may be the cause of injury.

Machine damage

Static Electricity charged human body due to rubbed clothes may cause the damage of electric element.

When repair the substrate such as a System Board or a Main Control Board, put a wrist strap or use a conductive mat to avoid ESD.

Notes when cleaning

When cleaning inside the device, be careful not to fall off the foreign matters, which adhered on such like rollers.

If foreign matters fell into the upper unit or the Base unit while cleaning, open the cover and then clean also the inner of the device.

How to remove the Plastic latch

The most of parts mounted with Plastic Latches.

When you removing parts, please remove it carefully because those Latches are easy to break.

Push the upper place of the Latch when you remove those parts.

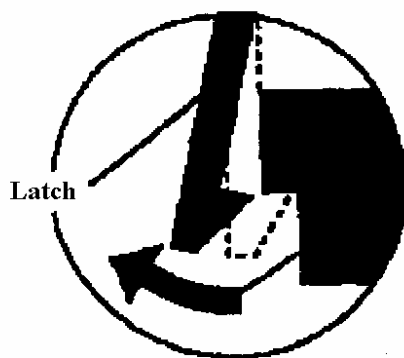

Do not give too much force when remove the parts from these latches.

05	Nov. 20, 2008	K.Okada	T.Anzai	I.Fujioka	Refer to Revision Record on page 2.	TITLE	fi-5530C/fi-5530C2 IMAGE SCANNER MAINTENANCE MANUAL		
04	July 7, 2008	K.Okada	T.Anzai	I.Fujioka	Refer to Revision Record on page 2.				
03	Feb.23, 2007	K.Okada	K.Okada	T.Anzai	Refer to Revision Record on page 2.				
						DRAW. No.	P1PA03334-B30X/6	CUST.	
Rev	DATE	DESIG.	CHECK	APPR.	DESCRIPTION	PFU LIMITED		PAGE	60/138
DESIG	Aug.19, 2005	K.Okada	CHECK	K.Okada	APPR. T.Anzai				

4-2. Maintenance

This section describes about basic maintenance service.

4-2-1 Periodic maintenance

This scanner is recommended to have periodic maintenance according to the following cycle.

Item	Maintenance cycle
Periodic maintenance	Every 12 months

At maintenance, clean the following areas, if they are dirty.

- ADF (Refer to [Section 1-7-1](#))
- Optical unit (Refer to [Section 4-3-1](#), [4-3-3](#))
- Glass of Dust cover (Refer to [Section 4-3-2](#))
- Glass of Upper Frame ASSY (Refer to [Section 4-3-4](#))

05	Nov. 20, 2008	K.Okada	T.Anzai	I.Fujioka	Refer to Revision Record on page 2.	TITLE fi-5530C/fi-5530C2 IMAGE SCANNER MAINTENANCE MANUAL	DRAW. No. P1PA03334-B30X/6	CUST.
04	July 7, 2008	K.Okada	T.Anzai	I.Fujioka	Refer to Revision Record on page 2.			
03	Feb.23, 2007	K.Okada	K.Okada	T.Anzai	Refer to Revision Record on page 2.			
Rev	DATE	DESIG.	CHECK	APPR.	DESCRIPTION	PFU LIMITED	PAGE	61/138
DESIG	Aug.19, 2005	K.Okada	CHECK	K.Okada	APPR. T.Anzai			

4-3 Cleaning

4-3-1 Cleaning Optical unit (for front side)

Follow the procedure below to clean the Optical unit.

- 1) Referring to [Section 4-10-6](#), remove the Optical unit.
- 2) Clean the mirrors inside the Optical unit with a dry lint-free cloth or a blower brush. Be sure that no fabric from the cloth remains on the mirror.
- 3) After cleaning, mount the Optical unit.

4-3-2 Cleaning glass of Dust Cover

Follow the procedure below to clean the glass of Dust cover.

- 1) Referring to [Section 4-10-3](#), remove the Dust cover, etc.
- 2) Clean the inside the glass of the Dust cover and reflector with a dry lint-free cloth moistened with alcohol. Be sure that no fabric from the cloth remains on the glass.
- 3) After cleaning, mount the removed parts.

4-3-3 Cleaning Optical unit (for backside)

Follow the procedure below to clean the Optical unit.

- 1) Referring to [Section 4-9-3](#), remove the Optical unit.
- 2) Clean the mirrors inside the Optical unit with a dry lint-free cloth or a blower brush. Be sure that no fabric from the cloth remains on the mirror.
- 3) After cleaning, mount the Optical unit.

4-3-4 Cleaning glass of Upper Frame ASSY

Follow the procedure below to clean the glass of Dust cover.

- 1) Referring to [Section 4-9-8](#), remove the Upper unit and Optical unit.
- 2) Clean the inside the glass of the Upper Frame ASSY with a dry lint-free cloth moistened with alcohol. Be sure that no fabric from the cloth remains on the glass.
- 3) After cleaning, mount the removed parts.

05	Nov. 20, 2008	K.Okada	T.Anzai	I.Fujioka	Refer to Revision Record on page 2.	TITLE	fi-5530C/fi-5530C2 IMAGE SCANNER MAINTENANCE MANUAL		
04	July 7, 2008	K.Okada	T.Anzai	I.Fujioka	Refer to Revision Record on page 2.				
03	Feb.23, 2007	K.Okada	K.Okada	T.Anzai	Refer to Revision Record on page 2.				
						DRAW. No.	P1PA03334-B30X/6	CUST.	
Rev	DATE	DESIG.	CHECK	APPR.	DESCRIPTION	PFU LIMITED		PAGE	62/138
DESIG	Aug.19, 2005	K.Okada	CHECK	K.Okada	APPR. T.Anzai				

4-4 Maintenance tool

Special tools to clean this scanner are shown in table 4-4.

Table 4-4

No.	Tools	When to use	Remarks
1	Philips screwdriver		For M2.5, M3
2	Spring balance	Belt tension adjustment	Max 1 kg force
3	Alcohol	Cleaning	Ethyl alcohol or isopropyl alcohol
4	Blower brush	Cleaning mirror	
5	Mini flat screwdriver	Removing parts	
6	Long-nose pliers	Connecting Cover open sensor	
7	White level adjustment sheet	White level adjustment (Section 5-1-5)	Description: TEST SHEET Part number: PA03277-Y123 Please purchase this sheet prior to maintenance.
8	Magnification/Offset adjustment sheet	Magnification/Offset adjustment (Section 5-1-3 , 5-1-4)	Required for offset or magnification adjustment. See figure 5-1-3 (Section 5-1-3) and prepare the sheet in advance, if you do not have the sheet.
9	Adhesive tape	To prevent Optical unit falling off when Upper cover is removed. (Note in Section 4-7-5)	

05	Nov. 20, 2008	K.Okada	T.Anzai	I.Fujioka	Refer to Revision Record on page 2.	TITLE fi-5530C/fi-5530C2 IMAGE SCANNER MAINTENANCE MANUAL	DRAW. No. P1PA03334-B30X/6	CUST.
04	July 7, 2008	K.Okada	T.Anzai	I.Fujioka	Refer to Revision Record on page 2.			
03	Feb.23, 2007	K.Okada	K.Okada	T.Anzai	Refer to Revision Record on page 2.			
Rev	DATE	DESIG.	CHECK	APPR.	DESCRIPTION	PFU LIMITED	PAGE	63/138
DESIG	Aug.19, 2005	K.Okada	CHECK	K.Okada	APPR. T.Anzai			

4-5 Non disassembly parts

The following screws and mirrors are adjusted and secured at shipment from factory. Do not attempt to disassemble nor loose them. Doing so will make it a requirement to replace the Optical Unit.

[Optical unit]

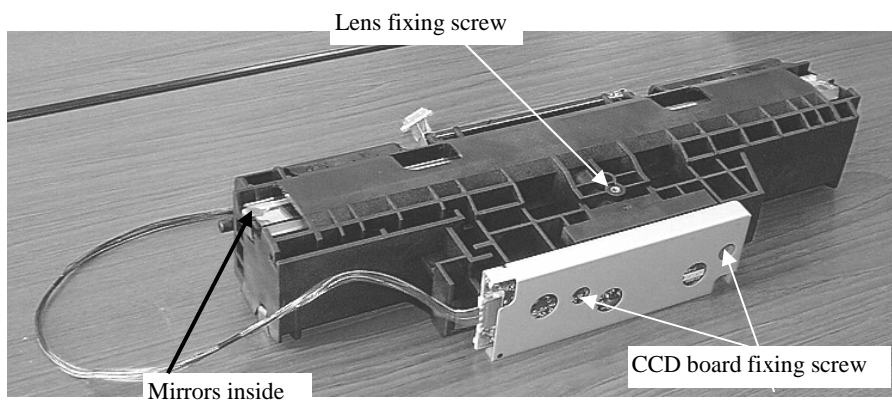

4-6 (Reserved)

05	Nov. 20, 2008	K.Okada	T.Anzai	I.Fujioka	Refer to Revision Record on page 2.	TITLE	fi-5530C/fi-5530C2 IMAGE SCANNER MAINTENANCE MANUAL		
04	July 7, 2008	K.Okada	T.Anzai	I.Fujioka	Refer to Revision Record on page 2.				
03	Feb.23, 2007	K.Okada	K.Okada	T.Anzai	Refer to Revision Record on page 2.				
						DRAW. No.	P1PA03334-B30X/6		CUST.
Rev	DATE	DESIG.	CHECK	APPR.	DESCRIPTION	PFU LIMITED		PAGE	64/138
DESIG	Aug.19, 2005	K.Okada	CHECK	K.Okada	APPR. T.Anzai				

4-7. Removing / Mounting Chute Unit, Stacker Unit, PCB Unit and Covers

4-7-1. Removing/Mounting the Chute unit (ADF paper chute)

Refer to [Section 6-25](#) for the part number of the replacement part.

<Removing>

Turn the Chute unit (ADF paper chute) upward, and Pull it out from the scanner. There is the claw on top of tabs to hook the Chute unit (ADF paper chute).

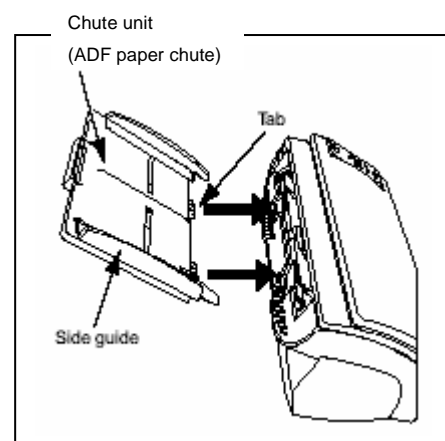
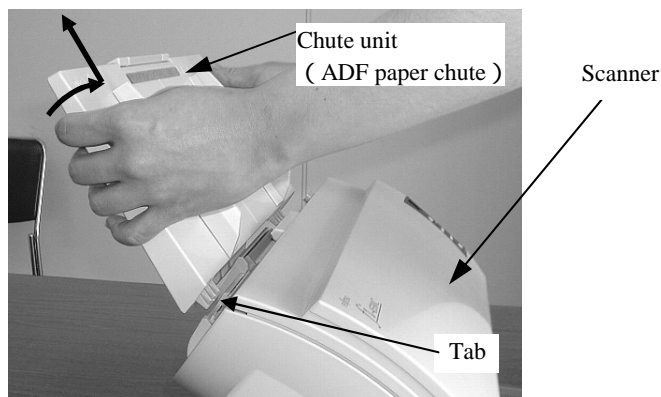
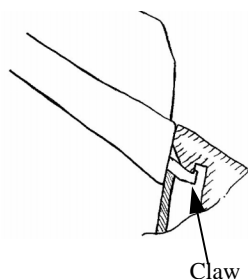

<Mounting>

Hold the Chute unit (ADF paper chute) and insert its tabs into the holes on the rear side of the scanner as shown in the figure on the right so that the side guides face up.

4-7-2. Removing/Mounting the Stacker Unit

Refer to [Section 6-24](#) for the part number of the replacement part.

<Removing>

- (1) Slide the Stacker unit to right until it touches the side face of cover. Turn the Stacker unit up about 45 degrees. Then pull and detach a fulcrum part, which touches the side face of cover.
- (2) Slide the Stacker to left until tit touches another end. Pull and detach another fulcrum part.

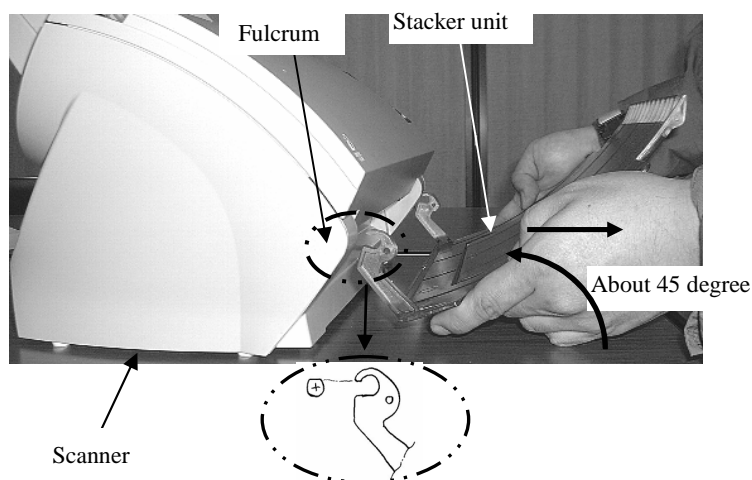

<Mounting>

Follow the above procedure in reverse.

05	Nov. 20, 2008	K.Okada	T.Anzai	I.Fujioka	Refer to Revision Record on page 2.	TITLE	fi-5530C/fi-5530C2 IMAGE SCANNER MAINTENANCE MANUAL		
04	July 7, 2008	K.Okada	T.Anzai	I.Fujioka	Refer to Revision Record on page 2.	DRAW. No.	P1PA03334-B30X/6		CUST.
03	Feb.23, 2007	K.Okada	K.Okada	T.Anzai	Refer to Revision Record on page 2.				
Rev	DATE	DESIG.	CHECK	APPR.	DESCRIPTION	PFU LIMITED		PAGE	65/138
DESIG	Aug.19, 2005	K.Okada	CHECK	K.Okada	APPR. T.Anzai				

4-7-3. Removing/Mounting the PCB unit

<Removing>

- (1) Remove the Chute unit (ADF paper chute) and Stacker by referring to [Section 4-7-1](#) and [4-7-2](#).
- (2) Remove 4 screws from the PCB unit, and open the PCB unit a little taking care not to pull the cables inside by force.

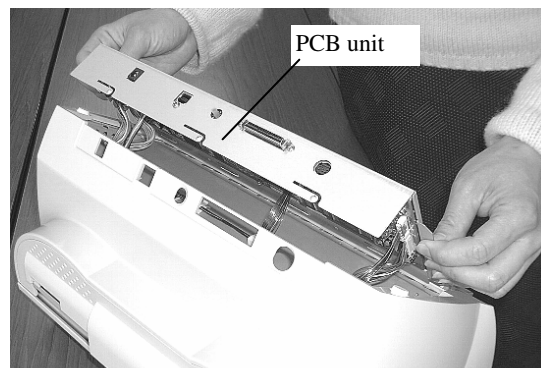
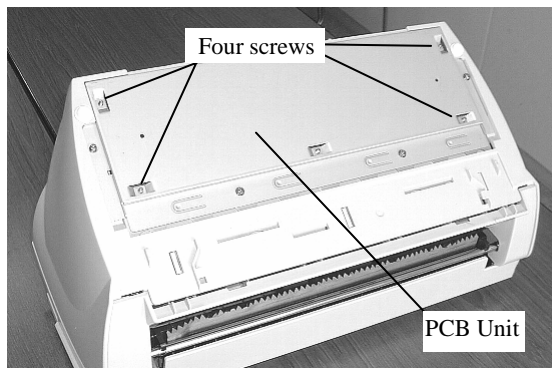

- (3) Disconnect 8 connectors, which are connected to the PCB Unit, and remove the PCB Unit. To replace Control PCA, go to [Section 4-11](#).

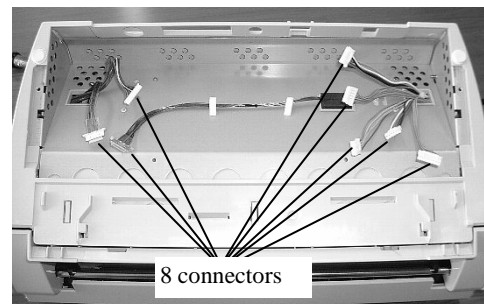

<Mounting>

Follow the above procedure in reverse.

Note 1: It is easy to connect the connectors, which are shown in the following figure. Connect the connectors as described in the following figure.

Note 2: Be careful not to pinch any cables between the PCB Unit and the scanner.

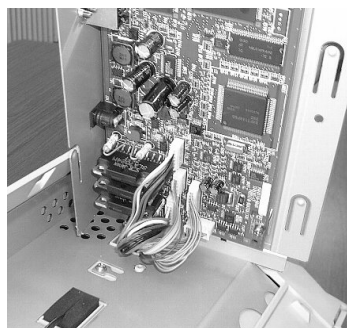

Colored wire, Medium (PICK Motor)

Colored wire, Small (BW Motor)

Colored wire, Large (LF Motor)

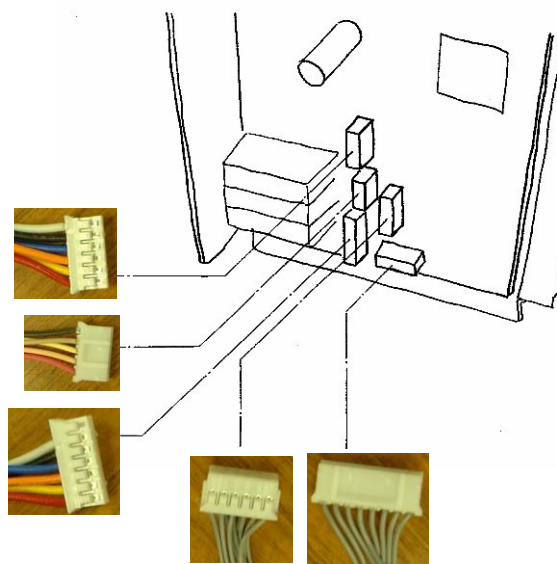

Gray wire, Small

Gray wire, large

05	Nov. 20, 2008	K.Okada	T.Anzai	I.Fujioka	Refer to Revision Record on page 2.	TITLE	fi-5530C/fi-5530C2 IMAGE SCANNER MAINTENANCE MANUAL		
04	July 7, 2008	K.Okada	T.Anzai	I.Fujioka	Refer to Revision Record on page 2.				
03	Feb.23, 2007	K.Okada	K.Okada	T.Anzai	Refer to Revision Record on page 2.				
						DRAW. No.	P1PA03334-B30X/6	CUST.	
Rev	DATE	DESIG.	CHECK	APPR.	DESCRIPTION	PFU LIMITED		PAGE	66/138
DESIG	Aug.19, 2005	K.Okada	CHECK	K.Okada	APPR. T.Anzai				

4-7-4. Removing/Mounting the Rear cover

NOTICE

Be careful not to touch the glass window as far as you can.

<Removing>

- (1) Remove Chute unit (ADF paper chute), Stacker unit and PCB unit by referring to Sections from [4-7-1](#) to [4-7-3](#).
- (2) Remove Guide P ASSY (sheet guide) by referring to [Section 4-10-1](#) (3).
- (3) Turn the scanner as shown in the right figure. Unlock two claws “A” shown in the following figure, and then detach the Rear cover.

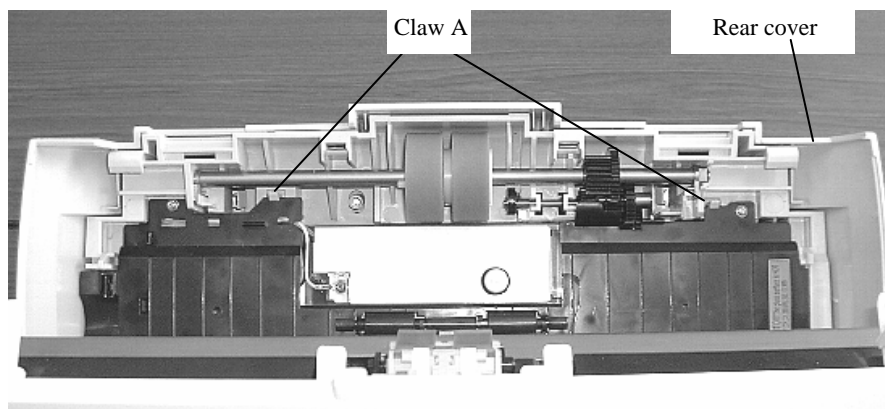
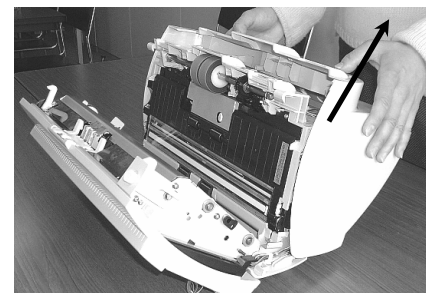

<Mounting>

Attach the Rear cover in the reverse order of removal.

Note 1: Before assembling Rear cover, confirm that the cables are placed to its original position.

Note 2: When assembling the Rear cover, confirm that a tab is inserted in the square hole of chassis, and then lock two claws shown in the following figure.

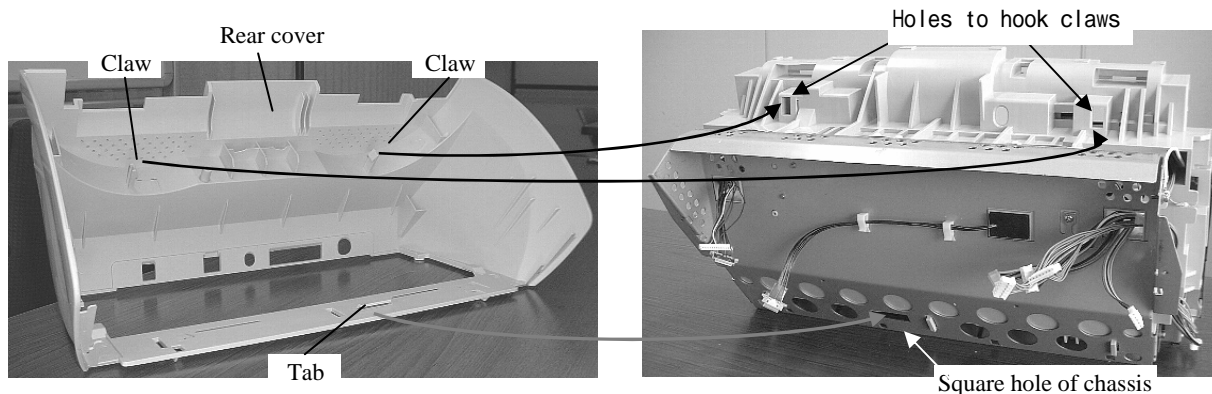

05	Nov. 20, 2008	K.Okada	T.Anzai	I.Fujioka	Refer to Revision Record on page 2.	TITLE fi-5530C/fi-5530C2 IMAGE SCANNER MAINTENANCE MANUAL	DRAW. No. P1PA03334-B30X/6	CUST.
04	July 7, 2008	K.Okada	T.Anzai	I.Fujioka	Refer to Revision Record on page 2.			
03	Feb.23, 2007	K.Okada	K.Okada	T.Anzai	Refer to Revision Record on page 2.			
Rev	DATE	DESIG.	CHECK	APPR.	DESCRIPTION	PFU LIMITED	PAGE	67/138
DESIG	Aug.19, 2005	K.Okada	CHECK	K.Okada	APPR. T.Anzai			

4-7-5. Removing/Mounting the Upper cover

<Removing>

- (1) Remove Panel PCA by referring to [Section 4-9-1](#).

Note: It is not necessary to save EEPROM data in the Control PCA, if Panel PCA will not be replaced.

- (2) Open the ADF. Turn a pulley in the direction of arrow in the right figure. And let the Pick-link plate move to front position as shown in the following figure. Then detach four link shafts from the ADF.

Pick link plate
Material marking shall
be opposite side.

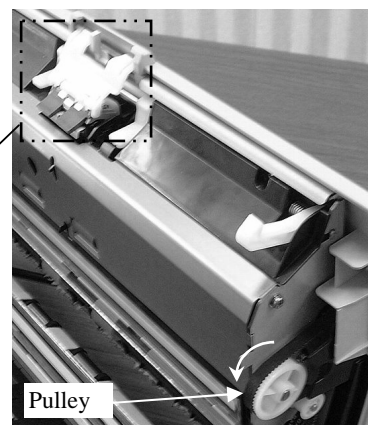
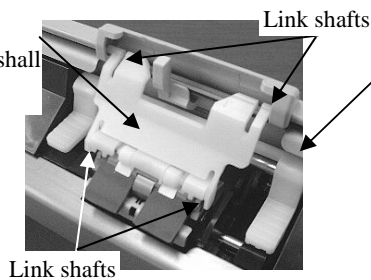

- (3) Remove two screws (Self-tapping screw) from TOP cover

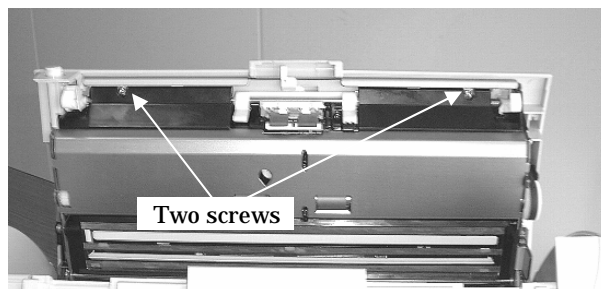

- (4) Open the ADF a little, and open Upper cover by about 2 cm. Push Upper cover in E direction and press B portion down to unlock the craws inside of the cover. Then detach the Upper cover

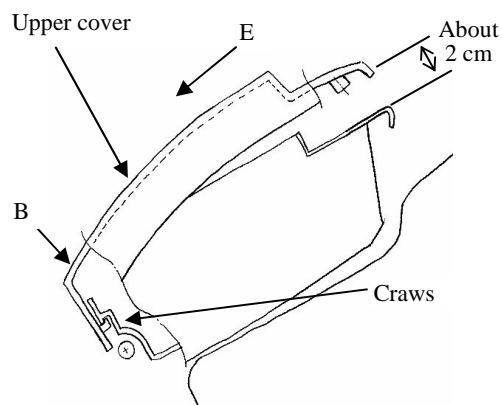
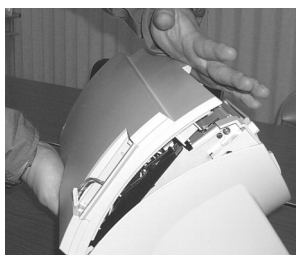

NOTICE

After removing the Upper cover, please attach an adhesive tape on the Optical unit to prevent it falling down as shown figure right. Also, when attaching Upper cover, remove this adhesive tape.

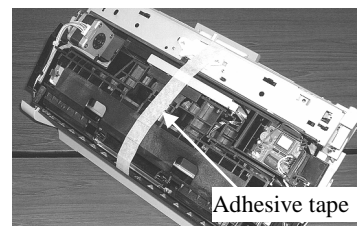

05	Nov. 20, 2008	K.Okada	T.Anzai	I.Fujioka	Refer to Revision Record on page 2.	TITLE	fi-5530C/fi-5530C2 IMAGE SCANNER MAINTENANCE MANUAL		
04	July 7, 2008	K.Okada	T.Anzai	I.Fujioka	Refer to Revision Record on page 2.				
03	Feb.23, 2007	K.Okada	K.Okada	T.Anzai	Refer to Revision Record on page 2.				
						DRAW. No.	P1PA03334-B30X/6		CUST.
Rev	DATE	DESIG.	CHECK	APPR.	DESCRIPTION	PFU LIMITED		PAGE	68/138
DESIG	Aug.19, 2005	K.Okada	CHECK	K.Okada	APPR.				

<Mounting>

Follow the removing procedure in reverse.

Note 1: Before assembling makes sure that the cables are placed to its original position, and Guide A ASSY is mounted.

Note 2: When attaching Upper cover, please follow,

- Align the edge of Upper cover and shaft of ADF, and align side of Upper cover and Rear cover,
- Then press Upper cover down.

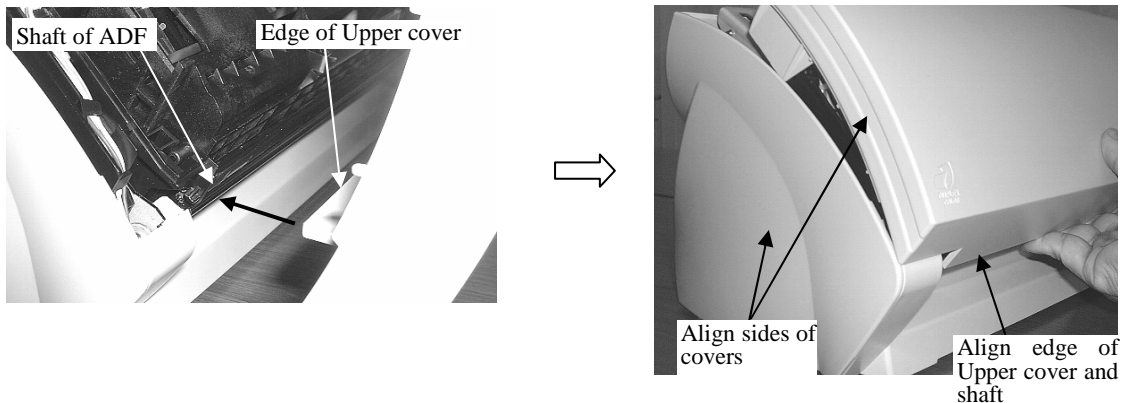

05	Nov. 20, 2008	K.Okada	T.Anzai	I.Fujioka	Refer to Revision Record on page 2.	TITLE	fi-5530C/fi-5530C2 IMAGE SCANNER MAINTENANCE MANUAL		
04	July 7, 2008	K.Okada	T.Anzai	I.Fujioka	Refer to Revision Record on page 2.				
03	Feb.23, 2007	K.Okada	K.Okada	T.Anzai	Refer to Revision Record on page 2.				
						DRAW. No.	P1PA03334-B30X/6		CUST.
Rev	DATE	DESIG.	CHECK	APPR.	DESCRIPTION	PFU LIMITED		PAGE	69/138
DESIG	Aug.19, 2005	K.Okada	CHECK	K.Okada	APPR. T.Anzai				

4-7-6. Removing/Mounting the Guide A ASSY

<Removing>

- (1) Remove Chute unit (ADF paper chute), Stacker unit, PCB unit, Rear cover and Upper cover by referring to Sections from [4-7-1](#) to [4-7-5](#).
- (2) Release four craws A from the bottom side of the scanner as shown in the following figure. And detach the Guide A ASSY.

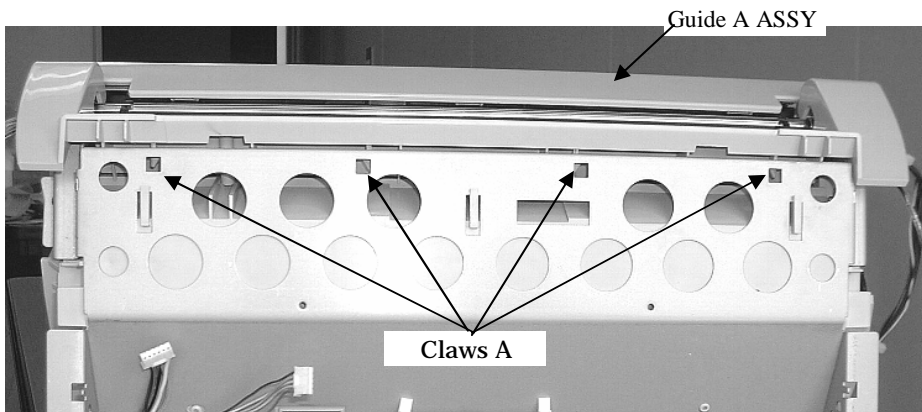

<Mounting>

Attach the Guide A ASSY in reverse order of removal. Lock the claws A above by paying attention to the following notes.

- Note 1: Insert the tab of Guide A ASSY first, and then insert the bracket of Base unit into the slots of ribs at both sides of Guide A ASSY. (See right figure)
- Note 2: Also insert the craws B of Guide A ASSY into the frame under the glass.

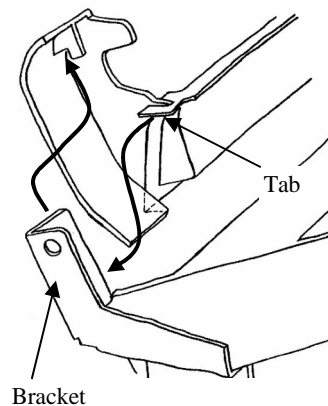
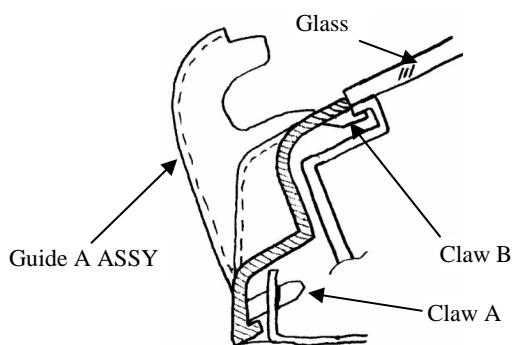

05	Nov. 20, 2008	K.Okada	T.Anzai	I.Fujioka	Refer to Revision Record on page 2.	TITLE fi-5530C/fi-5530C2 IMAGE SCANNER MAINTENANCE MANUAL	DRAW. No. P1PA03334-B30X/6	CUST.
04	July 7, 2008	K.Okada	T.Anzai	I.Fujioka	Refer to Revision Record on page 2.			
03	Feb.23, 2007	K.Okada	K.Okada	T.Anzai	Refer to Revision Record on page 2.			
Rev	DATE	DESIG.	CHECK	APPR.	DESCRIPTION	PFU LIMITED	PAGE	70/138
DESIG	Aug.19, 2005	K.Okada	CHECK	K.Okada	APPR. T.Anzai			

4-8. Replacing the Upper Unit and the Base Unit

NOTICE

Be careful not to touch the glass window as far as you can.
Refer to the following sections for the part numbers of the replacement parts.

Upper unit: [Section 6-14](#)

Base unit: [Section 6-1](#)

<Removing>

(1) Remove Chute unit (ADF paper chute), Stacker unit, PCB unit and Rear cover by referring to Sections from [4-7-1](#) to [4-7-4](#).

(2) Remove the cables at both side of the scanner from the holes of chassis. And remove those cables from the cable clamps (Two at each side).

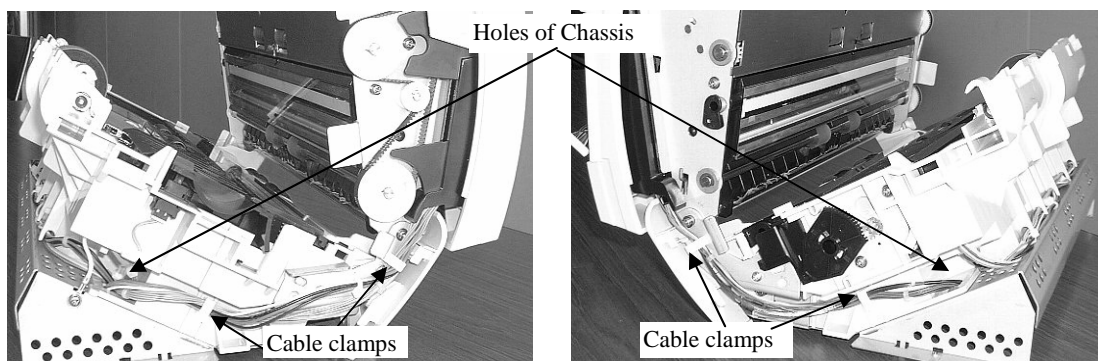

Note: Route the cables as shown in above figures when assembling.

(3) Remove two screws from both ends of the shaft.

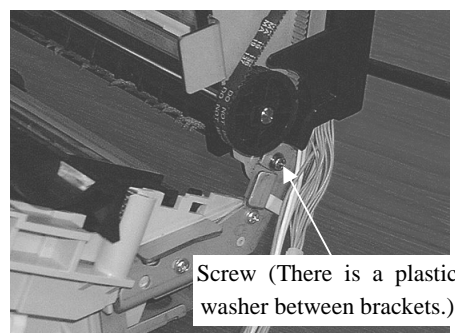
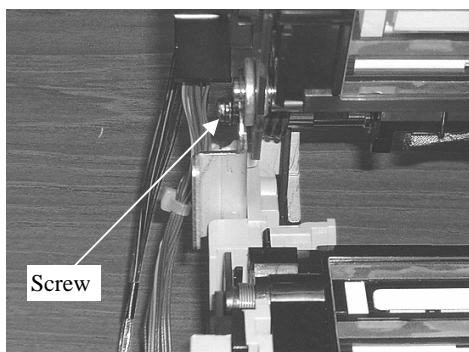

(4) Insert a small flat screwdriver between the brackets of fulcrum near the pulley, and then remove the shaft from the bracket of Base unit. Do not loose a plastic washer, which is located between the brackets.

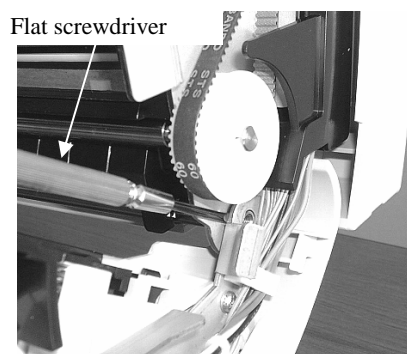
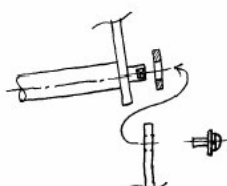

05	Nov. 20, 2008	K.Okada	T.Anzai	I.Fujioka	Refer to Revision Record on page 2.	TITLE	fi-5530C/fi-5530C2 IMAGE SCANNER MAINTENANCE MANUAL		
04	July 7, 2008	K.Okada	T.Anzai	I.Fujioka	Refer to Revision Record on page 2.	DRAW. No.	P1PA03334-B30X/6		CUST.
03	Feb.23, 2007	K.Okada	K.Okada	T.Anzai	Refer to Revision Record on page 2.				
Rev	DATE	DESIG.	CHECK	APPR.	DESCRIPTION	PFU LIMITED		PAGE	71/138
DESIG	Aug.19, 2005	K.Okada	CHECK	K.Okada	APPR. T.Anzai				

(5) Open Upper unit about 45 degree, and then slide it to the direction of arrow in the lower right figure to remove Upper unit,

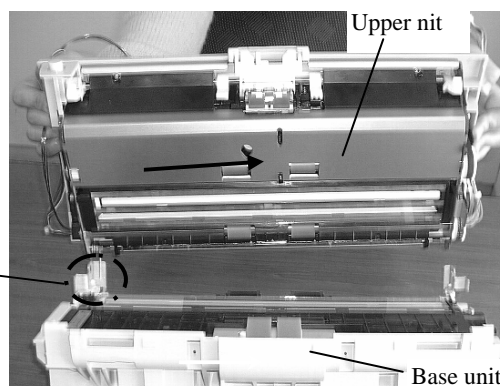
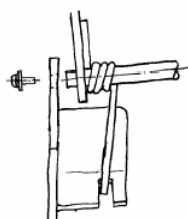

Note: When assembling the Upper unit, insert an arm of coil spring into a slot of bracket first, and insert the shaft to the hole of bracket as shown in the figure below. Then attach a plastic washer to another end of the shaft, and then insert the shaft into a hole of bracket as shown in the right figure. If a plastic washer is not inserted, the backside image may shift horizontally.

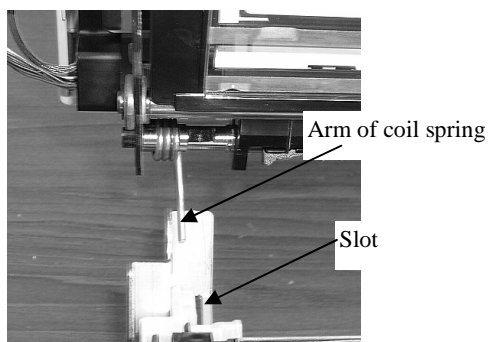
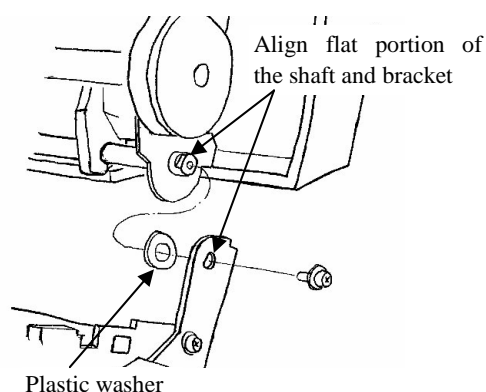

<Mounting>

Follow the above procedure in reverse, paying attention to the note below.

(1) Clean the glass of Upper unit and Base unit by a lint-free cloth moistened with alcohol.

(2) After mounting the Upper Unit and the Base Unit, perform the following adjustment:

- Offset adjustment (Refer to [Section 5-1-4](#))
- White balance adjustment (Refer to [Section 5-1-5](#))
- Magnification adjustment (Refer to [Section 5-1-3](#))

04

(3) ~~After replacing the Upper Unit, reset the Pad Counter as the Upper unit includes Pad ASSY. (Refer to [Section 5-1-6](#)).~~
 After replacing the Base unit, reset the Pick Counter as the Base unit includes the Pick roller. (Refer to [Section 5-1-6](#))

05	Nov. 20, 2008	K.Okada	T.Anzai	I.Fujioka	Refer to Revision Record on page 2.	TITLE fi-5530C/fi-5530C2 IMAGE SCANNER MAINTENANCE MANUAL	DRAW. No. P1PA03334-B30X/6	CUST.
04	July 7, 2008	K.Okada	T.Anzai	I.Fujioka	Refer to Revision Record on page 2.			
03	Feb.23, 2007	K.Okada	K.Okada	T.Anzai	Refer to Revision Record on page 2.			
Rev	DATE	DESIG.	CHECK	APPR.	DESCRIPTION	PFU LIMITED	PAGE	72/138
DESIG	Aug.19, 2005	K.Okada	CHECK	K.Okada	APPR. T.Anzai			

4-9. Replacing the parts in the Upper Unit

4-9-1. Replacing the Panel PCA

Refer to [Section 6-22](#) for the part number of the replacement part.

<Removing>

- (1) Temporarily move the EEPROM data installed on the Panel PCA into the Control PCA (Refer to [Section 5-2](#)).

Note: EEPROM is installed on the Panel PCA instead of the Control PCA for this scanner to reduce the data saving operations, since the Control PCA requires more frequent replacement than Panel PCA.

- (2) Insert a flat screwdriver into a gap of the Panel Cover and Upper Cover, and remove the Panel Cover by releasing a tab from Upper cover as shown below.

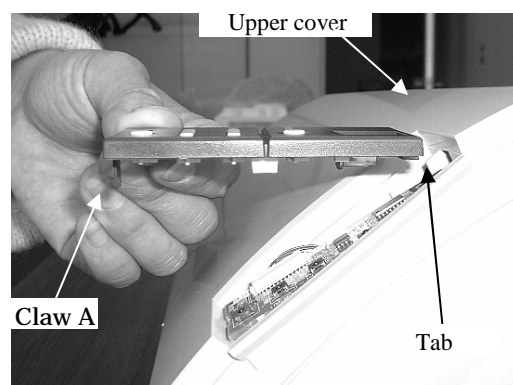
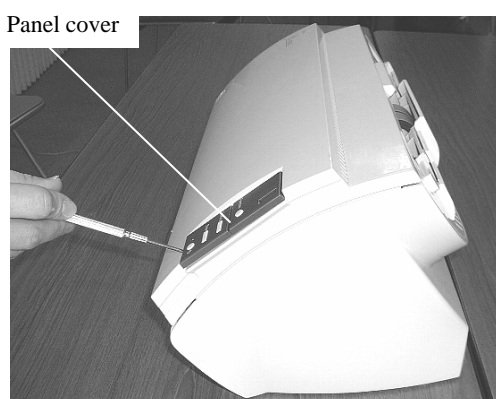

- (3) Take out the Panel PCA and disconnect one connector from the Panel PCA.

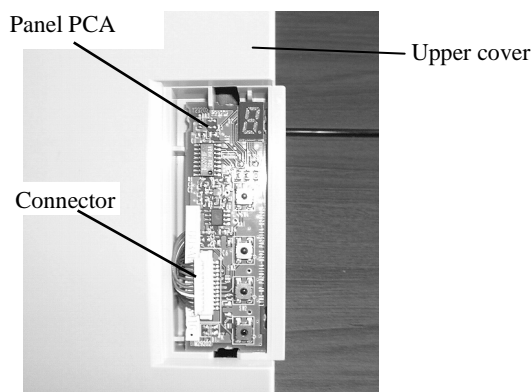

<Mounting>

- (1) Follow the removing procedure in reverse.
- (2) After mounting a new Panel PCA, overwrite the EEPROM data that has been saved on the Control PCA into the new Panel PCA. (Refer to [Section 5-1-8](#).)
- (3) Put the cables into the hole of Upper cover (see above photo). If the cables are accidentally placed between Panel PCA and Upper cover, the Panel PCA is lifted causing power button to be turned ON.

05	Nov. 20, 2008	K.Okada	T.Anzai	I.Fujioka	Refer to Revision Record on page 2.	TITLE	fi-5530C/fi-5530C2 IMAGE SCANNER MAINTENANCE MANUAL		
04	July 7, 2008	K.Okada	T.Anzai	I.Fujioka	Refer to Revision Record on page 2.	DRAW. No.	P1PA03334-B30X/6		CUST.
03	Feb.23, 2007	K.Okada	K.Okada	T.Anzai	Refer to Revision Record on page 2.				
Rev	DATE	DESIG.	CHECK	APPR.	DESCRIPTION	PFU LIMITED		PAGE	73/138
DESIG	Aug.19, 2005	K.Okada	CHECK	K.Okada	APPR. T.Anzai				

4-9-2. Replacing the Inverter SR

P/N of replacement part is described in [Section 6-4](#).

NOTICE

Conduct the procedure under dust-free environment.

<Removing>

- (1) Remove Chute unit (ADF paper chute), Stacker unit, PCB unit and Upper cover by referring to [Sections 4-7-1, 4-7-2](#) and [4-7-5](#).
- (2) Disconnect two connectors from Inverter SR, and detach a claw to remove it.

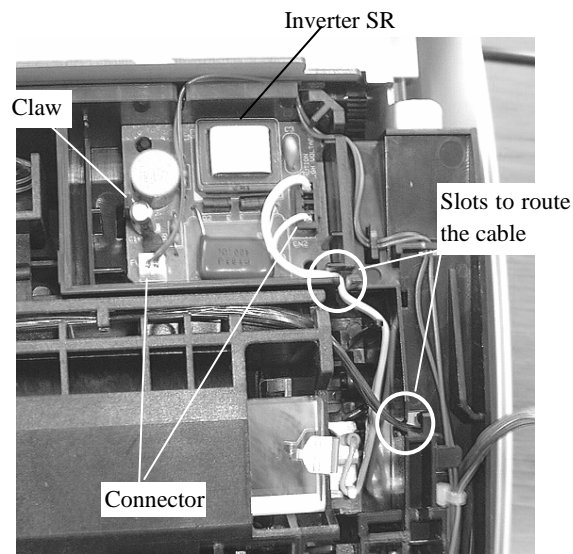

<Mounting>

Follow the removing procedure in reverse. Make sure the cables are placed through the slots in two locations as shown in the figure above.

05	Nov. 20, 2008	K.Okada	T.Anzai	I.Fujioka	Refer to Revision Record on page 2.	TITLE fi-5530C/fi-5530C2 IMAGE SCANNER MAINTENANCE MANUAL	DRAW. No. P1PA03334-B30X/6	CUST.
04	July 7, 2008	K.Okada	T.Anzai	I.Fujioka	Refer to Revision Record on page 2.			
03	Feb.23, 2007	K.Okada	K.Okada	T.Anzai	Refer to Revision Record on page 2.			
Rev	DATE	DESIG.	CHECK	APPR.	DESCRIPTION	PFU LIMITED	PAGE	74/138
DESIG	Aug.19, 2005	K.Okada	CHECK	K.Okada	APPR. T.Anzai			

4-9-3. Replacing the Optical unit, OPT unit with cable B and CCD Cable B

(For backside scanning)

NOTICE

As the dust-proof area in the scanner is opened by the following procedure, do not replace the following parts in a dusty room.

Refer to the following sections for the part numbers of the replacement parts.

Optical unit: [Section 6-10](#)

OPT unit with cable B: [Section 6-20](#)

CCD cable B: [Section 6-21](#)

<Removing>

For Optical unit:

(1) Remove Chute unit (ADF paper chute), Stacker unit and Upper cover by referring to Sections from [4-7-1](#), [4-7-2](#) and [4-7-5](#).

(2) Remove a connector from Optical unit, and remove CCD Cable B (Blue cable) from craws on Optical unit. Then detach Optical unit.

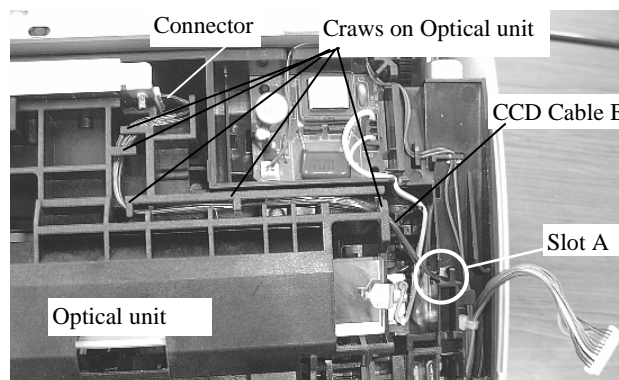

For OPT unit with cable B and CCD cable B:

(1) Remove Chute unit (ADF paper chute), Stacker unit, PCB unit, Rear cover and Upper cover by referring to Sections from [4-7-1](#) to [4-7-5](#).

(2) Remove CCD Cable B (Blue cable) from the hole of chassis and from the two cable clamps, which are shown in the right figure.

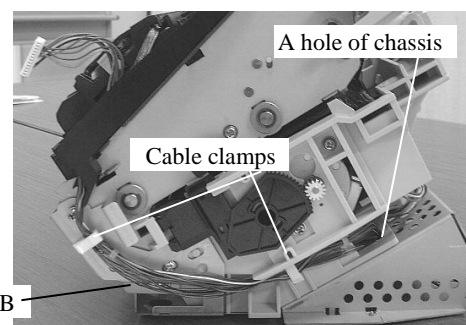

(3) Also remove CCD Cable B from the hooks of upper unit, shown in the bottom right figure, and then remove "OPT unit with Cable B" upward.

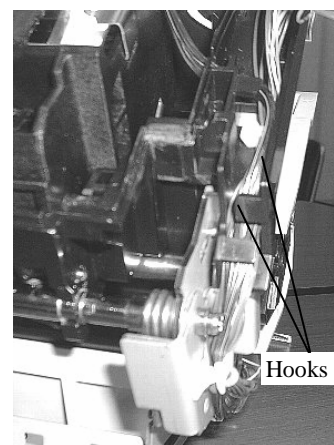
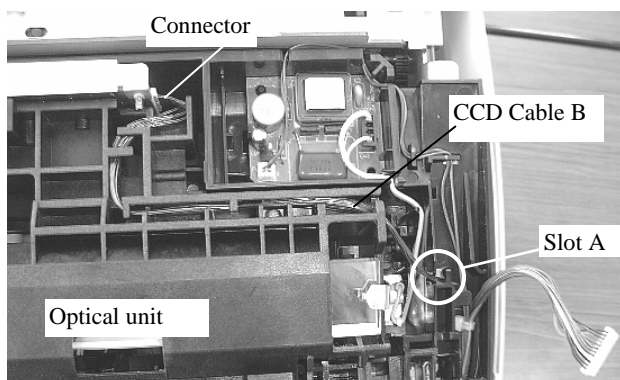

05	Nov. 20, 2008	K.Okada	T.Anzai	I.Fujioka	Refer to Revision Record on page 2.	TITLE	fi-5530C/fi-5530C2 IMAGE SCANNER MAINTENANCE MANUAL		
04	July 7, 2008	K.Okada	T.Anzai	I.Fujioka	Refer to Revision Record on page 2.				
03	Feb.23, 2007	K.Okada	K.Okada	T.Anzai	Refer to Revision Record on page 2.				
						DRAW. No.	P1PA03334-B30X/6		CUST.
Rev	DATE	DESIG.	CHECK	APPR.	DESCRIPTION	PFU LIMITED		PAGE	75/138
DESIG	Aug.19, 2005	K.Okada	CHECK	K.Okada	APPR. T.Anzai				

(4) Remove OPT unit with cable B. Remove CCD Cable B from OPT unit with cable B, when replacing it.

<Mounting>

Follow the removing procedure in reverse.

(1) If the mirrors inside the Optical unit is dirty, clean them with the blower brush or a dry lint-free cloth. Do not use alcohol as it may stain the mirror.

(2) Do not remove parts described in [Section 4-5](#).

(3) The cables should be routed in the way as shown above photo. Especially the cable shall be routed through slot A.

(4) After replacing Optical unit or Optical unit CB, run the following adjustment:

- Offset adjustment (Refer to [Section 5-1-4](#))
- White balance adjustment (Refer to [Section 5-1-5](#))
- Magnification adjustment (Refer to [Section 5-1-3](#))

05	Nov. 20, 2008	K.Okada	T.Anzai	I.Fujioka	Refer to Revision Record on page 2.	TITLE	fi-5530C/fi-5530C2 IMAGE SCANNER MAINTENANCE MANUAL		
04	July 7, 2008	K.Okada	T.Anzai	I.Fujioka	Refer to Revision Record on page 2.				
03	Feb.23, 2007	K.Okada	K.Okada	T.Anzai	Refer to Revision Record on page 2.				
						DRAW. No.	P1PA03334-B30X/6		CUST.
Rev	DATE	DESIG.	CHECK	APPR.	DESCRIPTION	PFU LIMITED		PAGE	76/138
DESIG	Aug.19, 2005	K.Okada	CHECK	K.Okada	APPR. T.Anzai				

4-9-4. Replacing the Lamp SR (for ADF backside)

NOTICE

As the dust-proof area in the scanner is opened by the following procedure, do not replace the following parts in a dusty room.

Refer to [Section 6-5](#) for the part number of the replacement part.

<Removing>

- (1) Remove Chute unit (ADF paper chute), Stacker unit and Upper cover by referring to Sections from [4-7-1](#), [4-7-2](#) and [4-7-5](#).
- (2) Remove the Optical unit by referring to [Section 4-9-3](#).
- (3) Disconnect the Lamp cable connector from the Inverter SR.
- (4) Release three craws from the Reflector, and then remove the assembly of Reflector and Lamp.

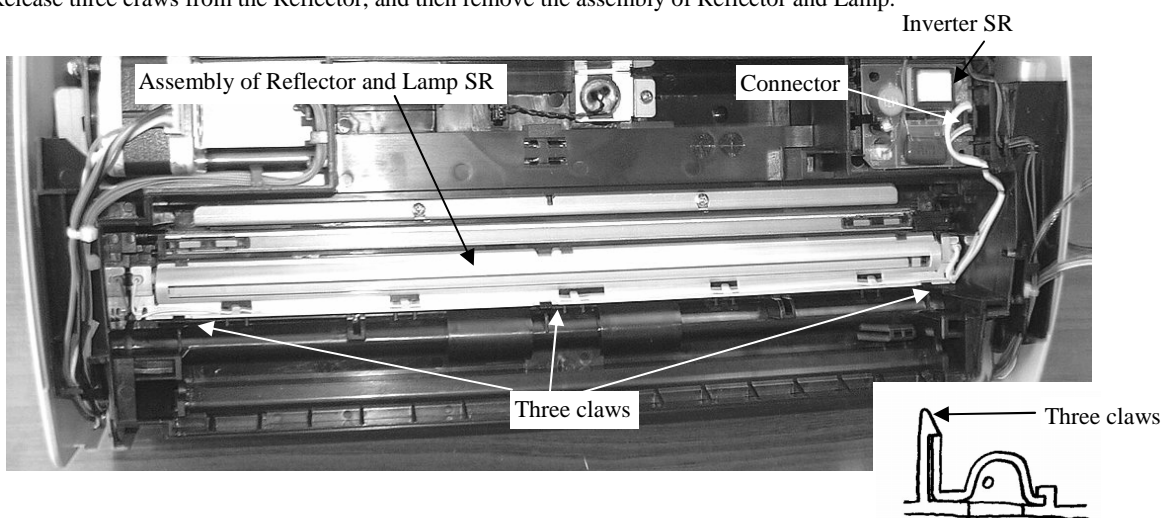

<Mounting>

- (1) Follow the removing procedure in reverse. Take care that slim cable is routed as follows.

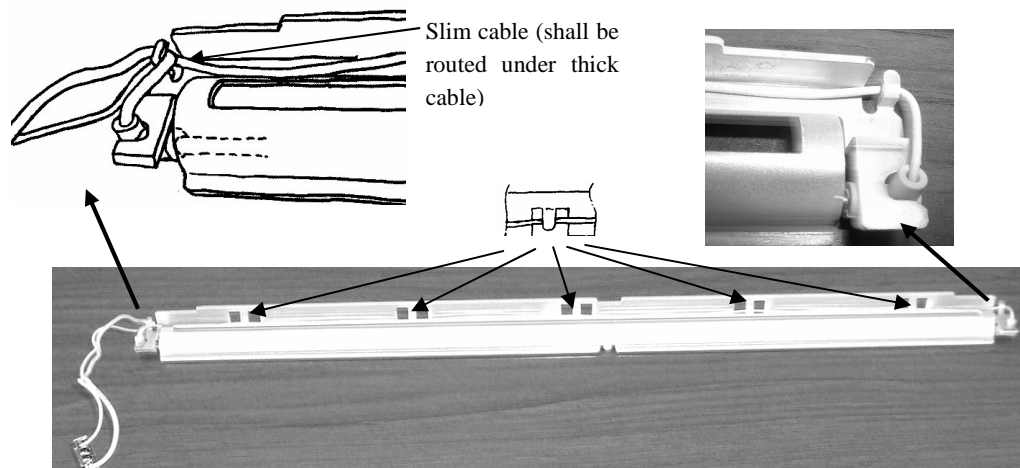

- (2) After mounting the Lamp SR, perform the following adjustment:

- Offset adjustment (Refer to [Section 5-1-4](#))
- White balance adjustment (Refer to [Section 5-1-5](#))
- Magnification adjustment (Refer to [Section 5-1-3](#))

05	Nov. 20, 2008	K.Okada	T.Anzai	I.Fujioka	Refer to Revision Record on page 2.	TITLE fi-5530C/fi-5530C2 IMAGE SCANNER MAINTENANCE MANUAL	DRAW. No. P1PA03334-B30X/6	CUST.
04	July 7, 2008	K.Okada	T.Anzai	I.Fujioka	Refer to Revision Record on page 2.			
03	Feb.23, 2007	K.Okada	K.Okada	T.Anzai	Refer to Revision Record on page 2.			
Rev	DATE	DESIG.	CHECK	APPR.	DESCRIPTION	PFU LIMITED		PAGE 77/138
DESIG	Aug.19, 2005	K.Okada	CHECK	K.Okada	APPR. T.Anzai			

4-9-5. Replacing the US Sensor (In Upper unit)

NOTICE

As the dust-proof area in the scanner is opened by the following procedure, do not replace the following parts in a dusty room.

Refer to [Section 6-6](#) for the part number of the replacement part.

<Removing>

- (1) Remove Chute unit (ADF paper chute), Stacker unit and Upper cover by referring the Sections from [4-7-1](#), [4-7-2](#) and [4-7-5](#).
- (2) Remove the Optical unit by referring to [Section 4-9-3](#).
- (3) There is the US Sensor under the Optical unit. Disconnect a connector of US sensor, and then remove a screw that secures a bracket to remove the US sensor.

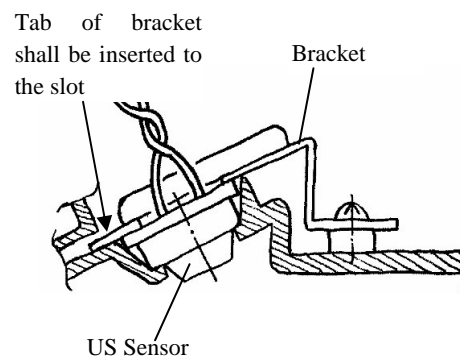
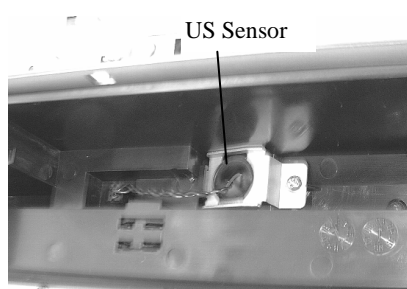

<Mounting>

- (1) Follow the removing procedure in reverse. When attaching the bracket, confirm that the tab of the bracket is inserted to the slot of the frame. The rotational position does not affect the sensing properties, but attach the sensor securely by the bracket.
- (2) After mounting the US sensor, run the Sensor testing by the Maintenance mode #1 described in [Section 5-1-2](#).

05	Nov. 20, 2008	K.Okada	T.Anzai	I.Fujioka	Refer to Revision Record on page 2.	TITLE fi-5530C/fi-5530C2 IMAGE SCANNER MAINTENANCE MANUAL	DRAW. No. P1PA03334-B30X/6	CUST.
04	July 7, 2008	K.Okada	T.Anzai	I.Fujioka	Refer to Revision Record on page 2.			
03	Feb.23, 2007	K.Okada	K.Okada	T.Anzai	Refer to Revision Record on page 2.			
Rev	DATE	DESIG.	CHECK	APPR.	DESCRIPTION	PFU LIMITED		PAGE 78/138
DESIG	Aug.19, 2005	K.Okada	CHECK	K.Okada	APPR. T.Anzai			

4-9-6. Replacing the LF Motor

NOTICE

As the dust-proof area in the scanner is opened by the following procedure, do not replace the following parts in a dusty room.

Refer to [Section 6-16](#) for the part number of the replacement part.

<Removing>

(1) Remove Chute unit (ADF paper chute), Stacker unit, PCB unit, Rear cover and Upper cover by referring to Sections from [4-7-1](#) to [4-7-5](#).

(2) Remove the cable from LF Motor from the hole of Chassis. Also remove the cable from two cable clamps and all hooks. Then remove two screws from the LF Motor and detach the LF Motor.

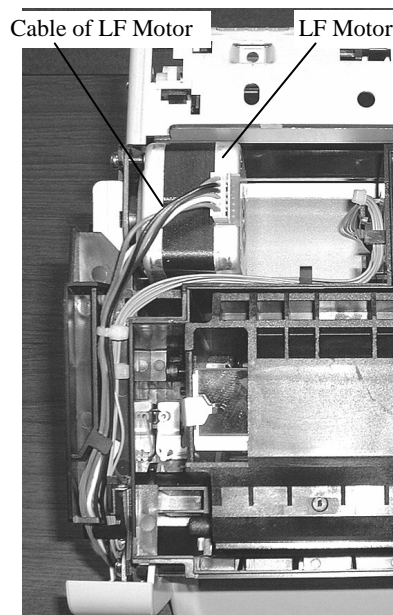
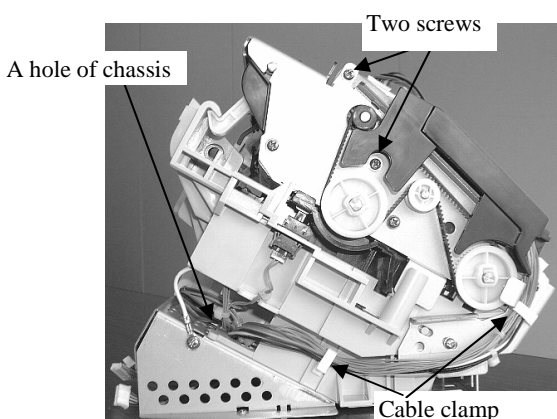

<Mounting>

Follow the removing procedure in reverse. Confirm that the cables are routed as shown in above figures.

When securing the screws of the motor, pull the motor up to apply the belt tension so that the tension becomes the value shown in the following figure.

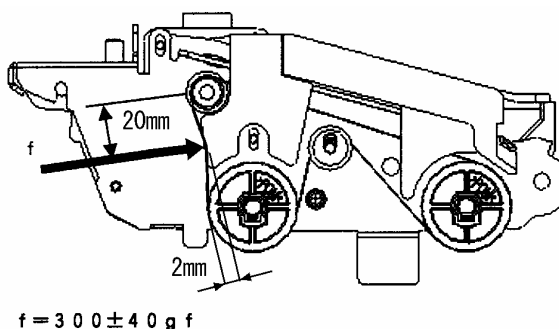

05	Nov. 20, 2008	K.Okada	T.Anzai	I.Fujioka	Refer to Revision Record on page 2.	TITLE fi-5530C/fi-5530C2 IMAGE SCANNER MAINTENANCE MANUAL	DRAW. No. P1PA03334-B30X/6	CUST.
04	July 7, 2008	K.Okada	T.Anzai	I.Fujioka	Refer to Revision Record on page 2.			
03	Feb.23, 2007	K.Okada	K.Okada	T.Anzai	Refer to Revision Record on page 2.			
Rev	DATE	DESIG.	CHECK	APPR.	DESCRIPTION	PFU LIMITED	PAGE	79/138
DESIG	Aug.19, 2005	K.Okada	CHECK	K.Okada	APPR. T.Anzai			

4-9-7. Replacing Sensor EM / Sensor PICK / Sensor TOP

NOTICE

As the dust-proof area in the scanner is opened by the following procedure, do not replace the following parts in a dusty room.

P/N of replacement parts are described in [Section 6-17](#), [6-18](#) and [6-19](#).

<Removing>

(1) Remove Chute unit (ADF paper chute), Stacker unit, PCB unit, Rear cover, Upper cover and Guide A ASSY by referring to Sections from [4-7-1](#) to [4-7-6](#).

(2) Remove the Optical unit (OPT unit with Cable B) by referring to [Section 4-9-3](#).

(3) Remove a connector on LF Motor.

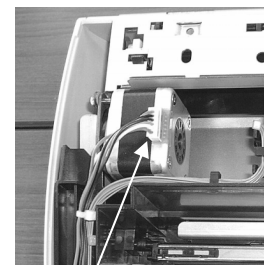

Connector on LF Motor

(4) Unhook the arm of coil spring from a hole of frame. Pull the Background lever.

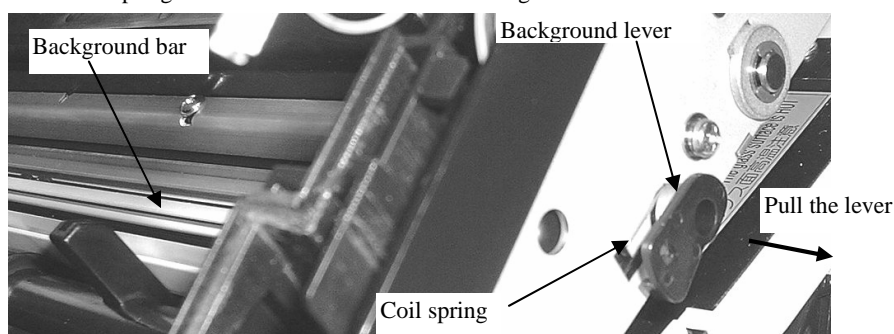

Note: Mounting procedure of the Background bar and Background lever is as follows.

- Place the Background bar with white face down, and insert the projection of the bar to a hole of frame. If the glass is dirty, please clean the glass before attaching the Background bar.
- Insert the Background lever by hooking the arms of the coil spring like the figure below. And adjust the angle of the Background lever to fit the cross tab to the cross hole of the Background bar.

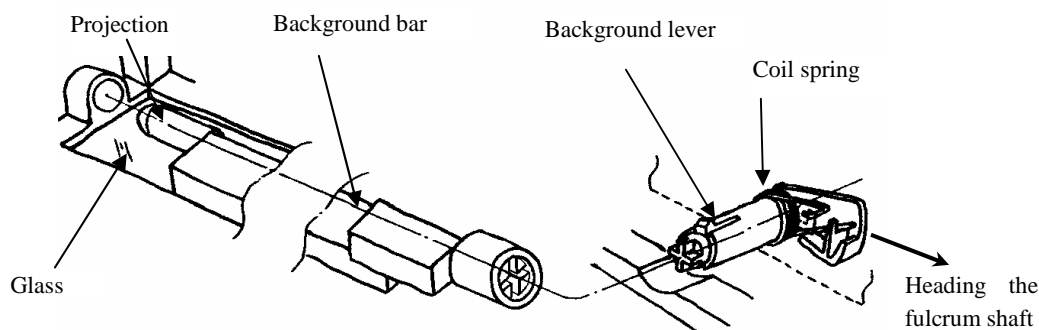

05	Nov. 20, 2008	K.Okada	T.Anzai	I.Fujioka	Refer to Revision Record on page 2.	TITLE	fi-5530C/fi-5530C2 IMAGE SCANNER MAINTENANCE MANUAL		
04	July 7, 2008	K.Okada	T.Anzai	I.Fujioka	Refer to Revision Record on page 2.				
03	Feb.23, 2007	K.Okada	K.Okada	T.Anzai	Refer to Revision Record on page 2.				
						DRAW. No.	P1PA03334-B30X/6		CUST.
Rev	DATE	DESIG.	CHECK	APPR.	DESCRIPTION	PFU LIMITED		PAGE	80/138
DESIG	Aug.19, 2005	K.Okada	CHECK	K.Okada	APPR. T.Anzai				

(5) Open the frame that mounts the sensors.

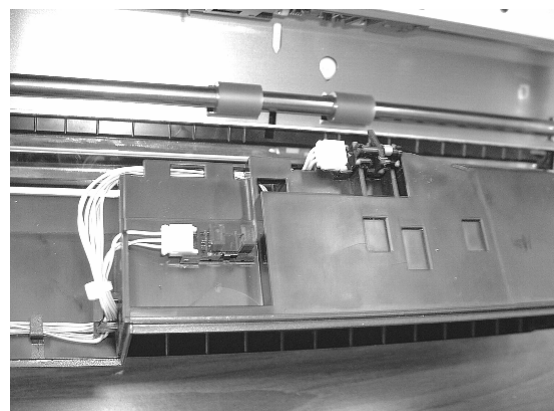
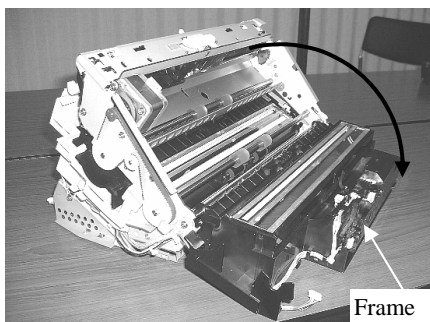

(6) Release the craws that fix the sensors and disconnect the connector of the sensor to remove.

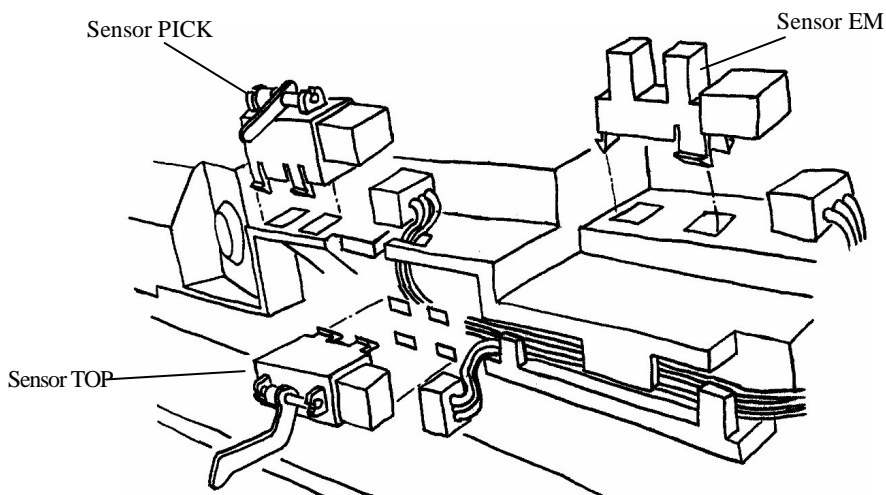

<Mounting>

Follow the removing procedure in reverse. Confirm the followings after mounting.

- (1) Make sure that the cables are routed in the way shown above figure.
- (2) All sensor levers move smoothly.

Finally, check the sensor performance by Maintenance mode #1 ([Section 5-1-2](#)) and adjust the offset by Maintenance mode #3 ([Section 5-1-4](#)).

05	Nov. 20, 2008	K.Okada	T.Anzai	I.Fujioka	Refer to Revision Record on page 2.	TITLE fi-5530C/fi-5530C2 IMAGE SCANNER MAINTENANCE MANUAL	DRAW. No. P1PA03334-B30X/6	CUST.
04	July 7, 2008	K.Okada	T.Anzai	I.Fujioka	Refer to Revision Record on page 2.			
03	Feb.23, 2007	K.Okada	K.Okada	T.Anzai	Refer to Revision Record on page 2.			
Rev	DATE	DESIG.	CHECK	APPR.	DESCRIPTION	PFU LIMITED	PAGE	81/138
DESIG	Aug.19, 2005	K.Okada	CHECK	K.Okada	APPR. T.Anzai			

4-9-8. Replacing the Upper Frame ASSY

NOTICE

As the dust-proof area in the scanner is opened by the following procedure, do not replace the following parts in a dusty room.

Refer to [Section 6-15](#) for the part number of the replacement part.

<Removing>

(1) Remove Chute unit (ADF paper chute), Stacker unit, PCB unit, Rear cover and Upper cover by referring to Sections from [4-7-1](#) to [4-7-5](#).

(2) Remove the Upper unit y referring [Section 4-8](#).

(3) Remove the Optical unit (OPT unit with Cable B) by referring to [Section 4-9-3](#).

The remainder is Upper unit. Upper Frame ASSY includes following parts.

- Lamp SR, Inverter SR
- YS sensor, sensor EM, Sensor PICK, Sensor TOP
- LF Motor, Pulley, Timing belt, Roller, Frame, Pad ASSY
- Cables

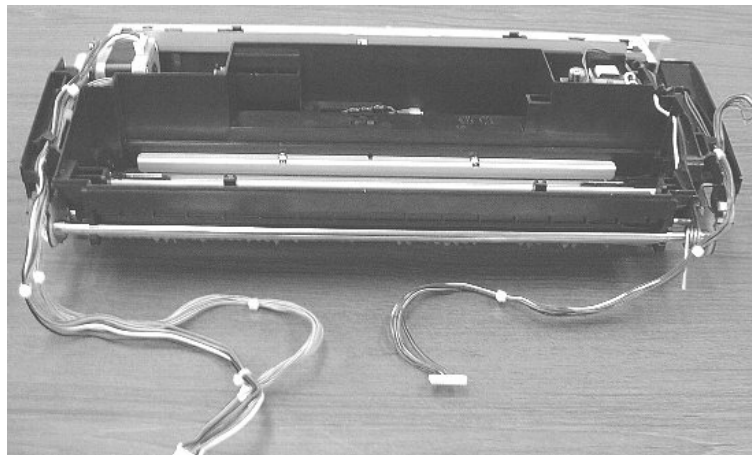

<Mounting>

(1) Follow the removing procedure in reverse. If the glass in the Upper unit is dirty, especially inside, clean it with a dry lint-free cloth.

(2) After mounting the parts, run the Offset adjustment ([Section 5-1-4](#)) and the Magnification adjustment ([Section 5-1-3](#)) for ADF back scanning, and the White level adjustment ([Section 5-1-5](#)) for ADF front/back scanning.

(3) Check the sensor performance by Maintenance mode #1 in [Section 5-1-2](#).

05	Nov. 20, 2008	K.Okada	T.Anzai	I.Fujioka	Refer to Revision Record on page 2.	TITLE	fi-5530C/fi-5530C2 IMAGE SCANNER MAINTENANCE MANUAL		
04	July 7, 2008	K.Okada	T.Anzai	I.Fujioka	Refer to Revision Record on page 2.				
03	Feb.23, 2007	K.Okada	K.Okada	T.Anzai	Refer to Revision Record on page 2.				
						DRAW. No.	P1PA03334-B30X/6		CUST.
Rev	DATE	DESIG.	CHECK	APPR.	DESCRIPTION	PFU LIMITED		PAGE	82/138
DESIG	Aug.19, 2005	K.Okada	CHECK	K.Okada	APPR. T.Anzai				

4-10. Replacing the parts in the Base Unit

4-10-1 Replacing the Guide P ASSY (sheet guide), US Sensor, US PCA

Refer to the following sections for the part numbers of the replacement parts.

Guide P ASSY (sheet guide): [Section 6-12](#)

US Sensor: [Section 6-6](#)

US PCA: [Section 6-7](#)

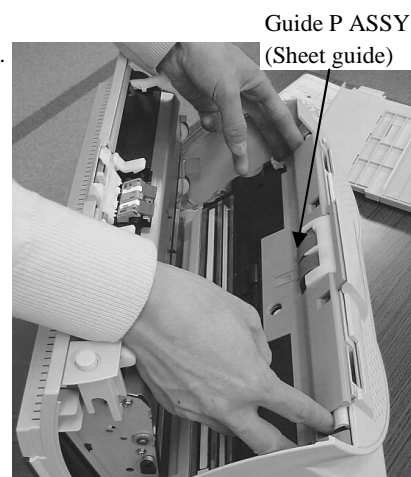

Removing following parts does not require any cover removal.

<Removing>

(1) Remove Chute unit (ADF paper chute) by referring to [Section 4-7-1](#).

(2) Open the ADF.

(3) Pinch two sides of Guide P ASSY (sheet guide) with a finger of both hands. Press tabs at both end of the Guide P ASSY (sheet guide) with another finger of both hands. And detach the Guide P ASSY (sheet guide). Refer to [Section 1-8-3](#) for details.

(4) Remove a screw that secures the cover plate of US sensor. And remove the bracket and US sensor.

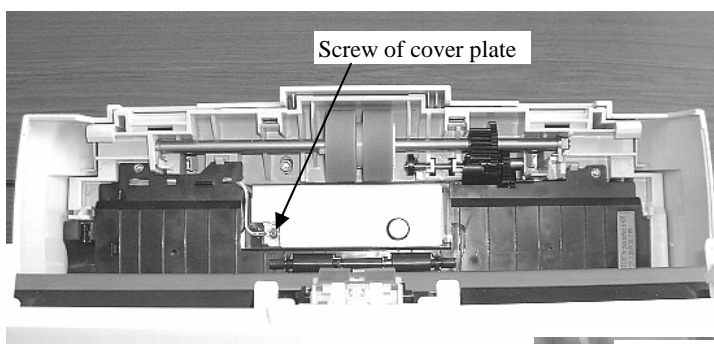

(5) When replacing US sensor:

Disconnect a cable from US sensor. Remove a screw that fixes a bracket, and remove the US sensor.

Reference: Same US sensors are used both Upper unit and Base unit. Upper one is ultrasonic emitter, and lower one is ultrasonic receiver.

When replacing US PCA:

Remove two connectors from US PCA.

Then detach the US PCA by removing it from a stud and claw.

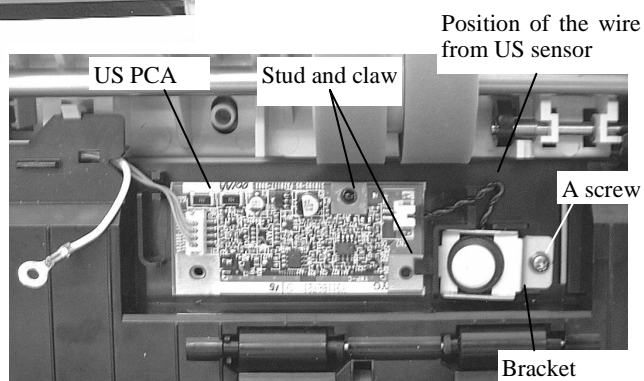

Tab shall be inserted here.

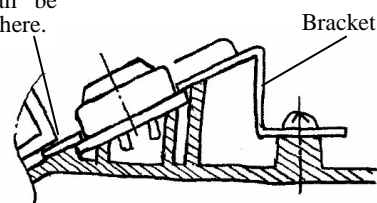

<Mounting>

(1) Follow the removing procedure in reverse. When attaching the bracket, confirm that the tab of the bracket is inserted to the slot of the frame. The rotational position does not affect the sensing properties, but attach the sensor securely by the bracket.

(2) After mounting the US sensor, run the Sensor testing by the Maintenance mode #1 described in [Section 5-1-2](#).

05	Nov. 20, 2008	K.Okada	T.Anzai	I.Fujioka	Refer to Revision Record on page 2.	TITLE	fi-5530C/fi-5530C2 IMAGE SCANNER		
04	July 7, 2008	K.Okada	T.Anzai	I.Fujioka	Refer to Revision Record on page 2.		MAINTENANCE MANUAL		
03	Feb.23, 2007	K.Okada	K.Okada	T.Anzai	Refer to Revision Record on page 2.	DRAW. No.	P1PA03334-B30X/6		CUST.
Rev	DATE	DESIG.	CHECK	APPR.	DESCRIPTION	PFU LIMITED		PAGE	83/138
DESIG	Aug.19, 2005	K.Okada	CHECK	K.Okada	APPR. T.Anzai				

4-10-2. Replacing the HK Ring SR

NOTICE

As the dust-proof area in the scanner is opened by the following procedure, do not replace the following parts in a dusty room. Refer to [Section 6-3](#) for the part number of the replacement part.

<Removing>

- (1) Remove Chute unit (ADF paper chute), Stacker unit, PCB unit, Rear cover and Guide A ASSY by referring to Sections from [4-7-1](#) to [4-7-4](#) and [4-7-6](#).
- (2) Slide the shaft of the plastic roller in the direction of arrow (see right), and rotate the shaft to make flat portion of the shaft vertical. Take out the roller and shaft assembly.

When attaching plastic rollers and shaft, the flat portion of shaft shall face following direction.

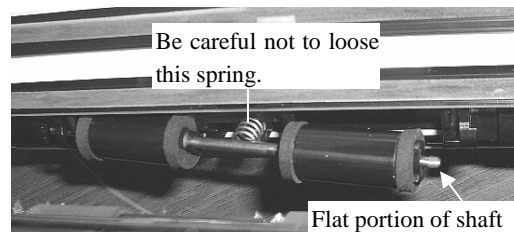
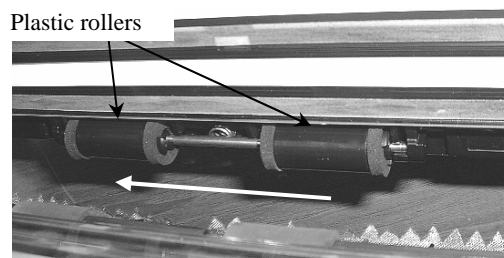
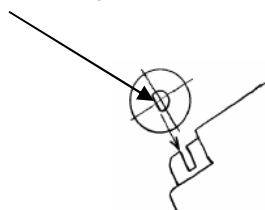

- (3) Remove two plastic rollers from the shaft, and remove HK ring SR (4 pieces) from both ends of plastic rollers.

Handle HK ring carefully as it is easy to break.

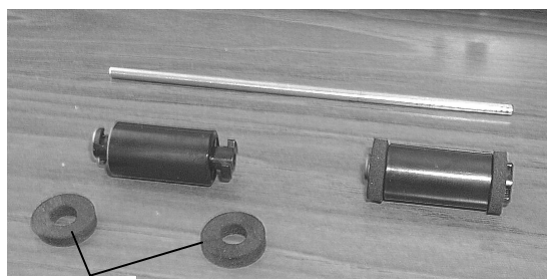

HK Ring SR

<Mounting>

Follow the removing procedure in reverse. If the glasses in ADF are dirty, clean them by a dry lint-free cloth.

05	Nov. 20, 2008	K.Okada	T.Anzai	I.Fujioka	Refer to Revision Record on page 2.	TITLE fi-5530C/fi-5530C2 IMAGE SCANNER MAINTENANCE MANUAL	DRAW. No. P1PA03334-B30X/6	CUST.
04	July 7, 2008	K.Okada	T.Anzai	I.Fujioka	Refer to Revision Record on page 2.			
03	Feb.23, 2007	K.Okada	K.Okada	T.Anzai	Refer to Revision Record on page 2.			
Rev	DATE	DESIG.	CHECK	APPR.	DESCRIPTION	PFU LIMITED	PAGE	84/138
DESIG	Aug.19, 2005	K.Okada	CHECK	K.Okada	APPR. T.Anzai			

4-10-3. Replacing the Dust cover

NOTICE

As the dust-proof area in the scanner is opened by the following procedure, do not replace the following parts in a dusty room.

Refer to [Section 6-2](#) for the part number of the replacement part.

<Removing>

(1) Remove Pick roller by referring to [Section 1-8-3](#). Remove Chute unit (ADF paper chute), Stacker unit, PCB unit, Rear cover, Upper cover and Guide A ASSY by referring to Sections from [4-7-1](#) to [4-7-6](#).

(2) Remove a screw that fixing FG cable, and remove a connector from Cover open sensor. Then remove the sensor cable from a hole of chassis.

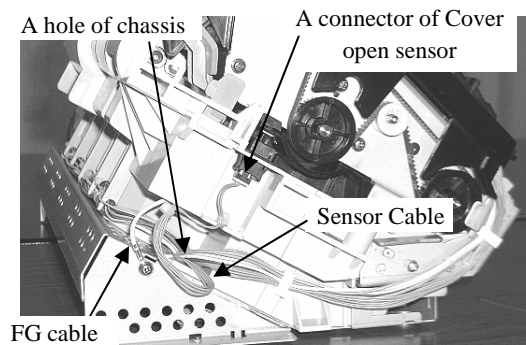

(3) Remove two screws from Base unit.

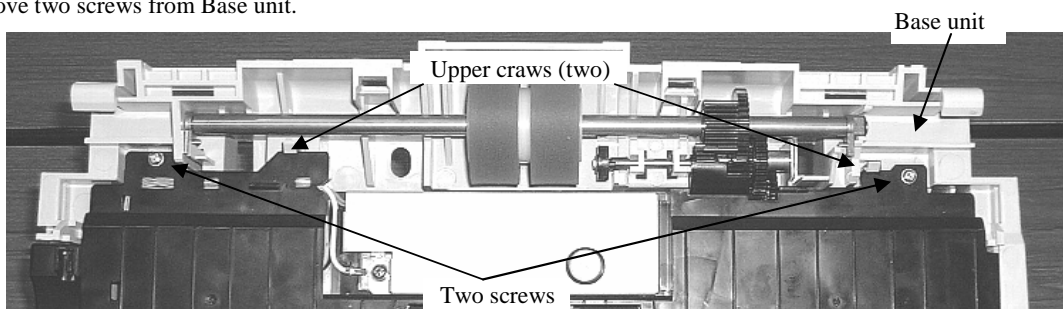

(4) Release two upper craws and two lower craws, and then remove Dust cover taking care that the cables from Dust cover shall not be pulled by force.

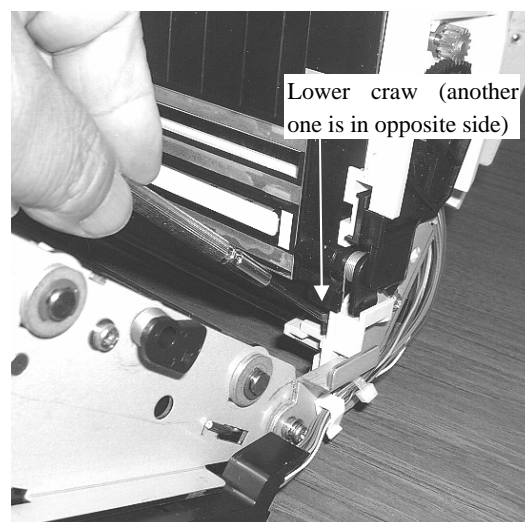
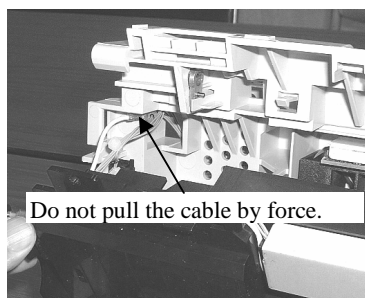

Reference: Dust cover includes following parts.
Lamp SR, Inverter SR, US sensor, US PCA, HK Ring SR

05	Nov. 20, 2008	K.Okada	T.Anzai	I.Fujioka	Refer to Revision Record on page 2.	TITLE fi-5530C/fi-5530C2 IMAGE SCANNER MAINTENANCE MANUAL	DRAW. No. P1PA03334-B30X/6	CUST.
04	July 7, 2008	K.Okada	T.Anzai	I.Fujioka	Refer to Revision Record on page 2.			
03	Feb.23, 2007	K.Okada	K.Okada	T.Anzai	Refer to Revision Record on page 2.			
Rev	DATE	DESIG.	CHECK	APPR.	DESCRIPTION	PFU LIMITED	PAGE	85/138
DESIG	Aug.19, 2005	K.Okada	CHECK	K.Okada	APPR. T.Anzai			

<Mounting>

Follow the removing procedure in reverse.

Note 1: Before attaching Dust cover, confirm that the cable from the lamp shall be routed as shown in right figure.

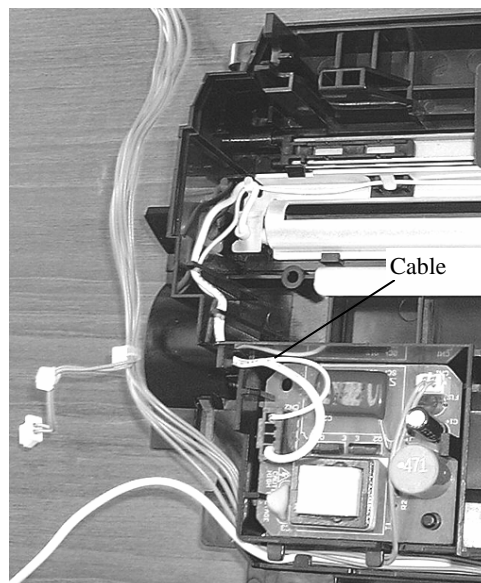

Note 2: When connecting a cable to Cover open sensor, a cable band shall be placed on U-shape slot of the frame. This cable setting is important to avoid the cable be disconnected by pulling the cable at assembling the scanner later. Long-nose pliers may be necessary to connect the cable to Cover open sensor.

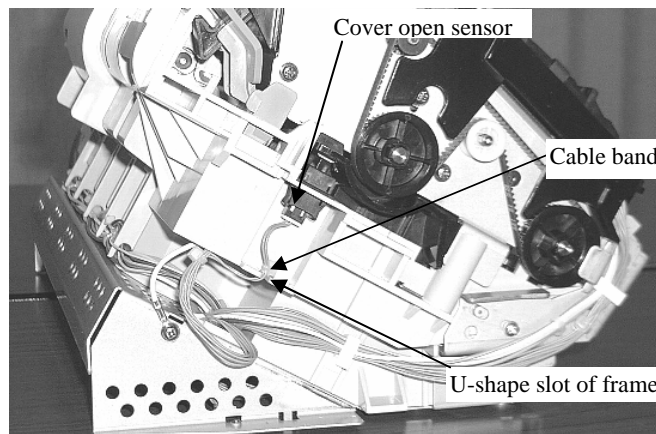

05	Nov. 20, 2008	K.Okada	T.Anzai	I.Fujioka	Refer to Revision Record on page 2.	TITLE	fi-5530C/fi-5530C2 IMAGE SCANNER MAINTENANCE MANUAL		
04	July 7, 2008	K.Okada	T.Anzai	I.Fujioka	Refer to Revision Record on page 2.				
03	Feb.23, 2007	K.Okada	K.Okada	T.Anzai	Refer to Revision Record on page 2.				
						DRAW. No.	P1PA03334-B30X/6	CUST.	
Rev	DATE	DESIG.	CHECK	APPR.	DESCRIPTION	PFU LIMITED		PAGE	86/138
DESIG	Aug.19, 2005	K.Okada	CHECK	K.Okada	APPR. T.Anzai				

4-10-4. Replacing the Inverter SR (for front side scanning)

NOTICE

As the dust-proof area in the scanner is opened by the following procedure, do not replace the following parts in a dusty room.

P/N of replacement part is described in [Section 6-4](#).

<Removing>

- (1) Remove Chute unit (ADF paper chute), Stacker unit, PCB unit, Rear cover, Upper cover and Guide A ASSY by referring Sections from [4-7-1](#) to [4-7-6](#).
- (2) Remove the Dust cover by referring to [Section 4-10-3](#).
- (3) Remove two connectors from the Inverter SR that is attached to the inner side of the Dust cover. And release a claw to remove the Inverter SR.

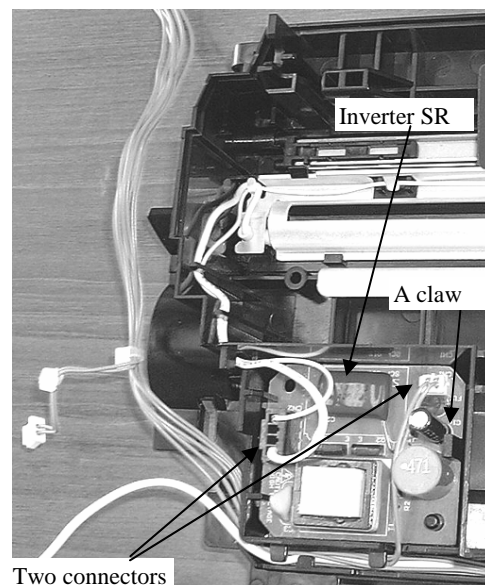

<Mounting>

Follow the removing procedure in reverse. The cable from the Lamp SR shall be routed as shown in the figure above.

05	Nov. 20, 2008	K.Okada	T.Anzai	I.Fujioka	Refer to Revision Record on page 2.	TITLE fi-5530C/fi-5530C2 IMAGE SCANNER MAINTENANCE MANUAL	DRAW. No. P1PA03334-B30X/6	CUST.
04	July 7, 2008	K.Okada	T.Anzai	I.Fujioka	Refer to Revision Record on page 2.			
03	Feb.23, 2007	K.Okada	K.Okada	T.Anzai	Refer to Revision Record on page 2.			
Rev	DATE	DESIG.	CHECK	APPR.	DESCRIPTION	PFU LIMITED		PAGE
DESIG	Aug.19, 2005	K.Okada	CHECK	K.Okada	APPR. T.Anzai			87/138

4-10-5. Replacing the Lamp SR (for ADF front)

NOTICE

As the dust-proof area in the scanner is opened by the following procedure, do not replace the following parts in a dusty room.

Refer to [Section 6-5](#) for the part number of the replacement part.

<Removing>

(1) Remove Chute unit (ADF paper chute), Stacker unit, PCB unit, Rear cover, Upper cover and Guide A ASSY by referring to Sections from [4-7-1](#) to [4-7-6](#).

(2) Remove the Dust cover by referring to [Section 4-10-3](#).

(3) Loosen two screws, and remove the Black sheet from Dust cover.

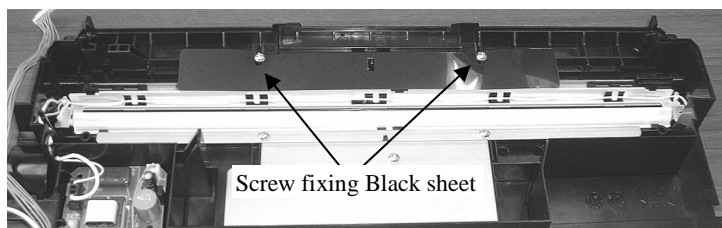

(4) Release three craws A that fix the Reflector of the lamp.

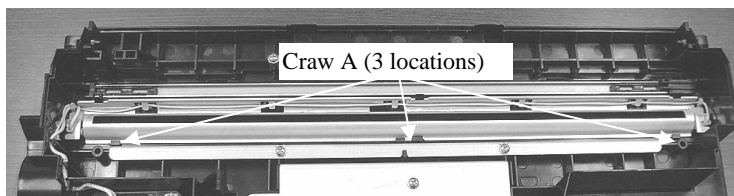
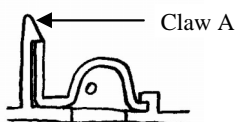

(5) Remove the Lamp SR form the Reflector.

<Mounting>

(1) Follow the removing procedure in reverse. If the glass of the Dust cover and the inside of the reflector are dirty, clean them.

(2) Take care that the cables are routed as follows.

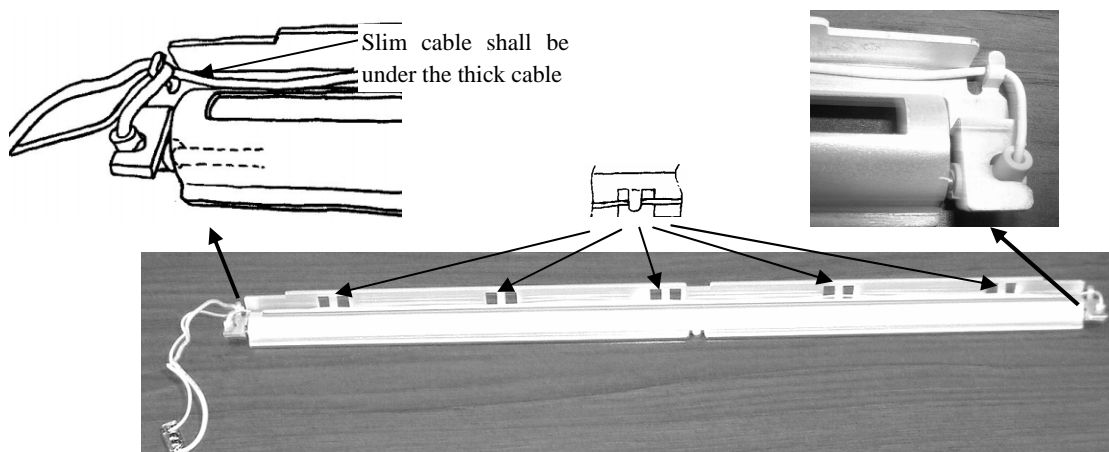

(3) After mounting the Lamp, perform the following adjustment:

- White balance adjustment ([Section 5-1-5](#))
- Offset adjustment ([Section 5-1-4](#))
- Magnification adjustment ([Section 5-1-3](#))

05	Nov. 20, 2008	K.Okada	T.Anzai	I.Fujioka	Refer to Revision Record on page 2.	TITLE fi-5530C/fi-5530C2 IMAGE SCANNER MAINTENANCE MANUAL	DRAW. No. P1PA03334-B30X/6	CUST.
04	July 7, 2008	K.Okada	T.Anzai	I.Fujioka	Refer to Revision Record on page 2.			
03	Feb.23, 2007	K.Okada	K.Okada	T.Anzai	Refer to Revision Record on page 2.			
Rev	DATE	DESIG.	CHECK	APPR.	DESCRIPTION	PFU LIMITED	PAGE	88/138
DESIG	Aug.19, 2005	K.Okada	CHECK	K.Okada	APPR. T.Anzai			

4-10-6. Replacing the Optical Unit, OPT unit with Cable F, CCD Cable F

(for front scanning)

NOTICE

As the dust-proof area in the scanner is opened by the following procedure, do not replace the following parts in a dusty room.

Refer to the following sections for the part numbers of the replacement parts.

Optical unit: [Section 6-10](#)

OPT unit with Cable F: [Section 6-8](#)

CCD Cable F: [Section 6-9](#)

<Removing>

(1) Remove Chute unit (ADF paper chute), Stacker unit, PCB unit, Rear cover, Upper cover and Guide A ASSY by referring to Sections from [4-7-1](#) to [4-7-6](#).

(2) Remove the Dust cover by referring to [Section 4-10-3](#).

(3) Remove CCD Cable F from two cable clamps at the bottom of the scanner.

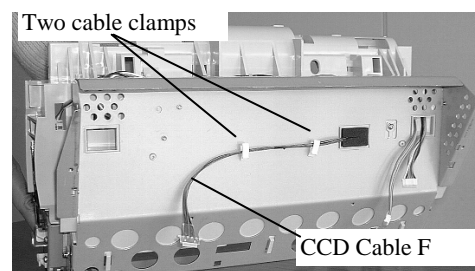

(4) Lift up the Optical unit while gently pulling CCD cable F through a slot of rubber. Finally push the connector of CCD cable F by your finger to remove Optical unit (OPT Unit with Cable F).

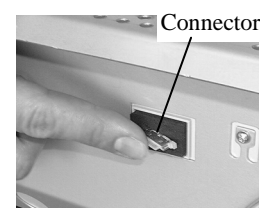

(5) Remove the CCD Cable F from the Optical unit by releasing the cable from the hooks and disconnecting the connector.

<Mounting>

(1) If the mirrors in the Optical unit are dirty, clean them using a blower brush or a dry lint-free cloth. Do not use alcohol as it may stain the mirror.

(2) Do not remove parts described in [Section 4-5](#).

(3) Follow the removing procedure in reverse. The CCD cable F shall be routed and hooked as shown in the right figure.

(4) After mounting the Optical Unit, run the following adjustment:

- Offset adjustment ([Section 5-1-4](#))
- White balance adjustment ([Section 5-1-5](#))
- Magnification adjustment ([Section 5-1-3](#))

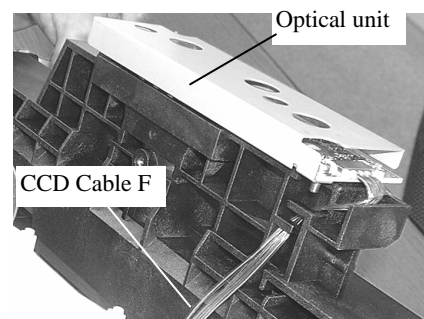

05	Nov. 20, 2008	K.Okada	T.Anzai	I.Fujioka	Refer to Revision Record on page 2.	TITLE	fi-5530C/fi-5530C2 IMAGE SCANNER MAINTENANCE MANUAL		
04	July 7, 2008	K.Okada	T.Anzai	I.Fujioka	Refer to Revision Record on page 2.	DRAW. No.	P1PA03334-B30X/6		CUST.
03	Feb.23, 2007	K.Okada	K.Okada	T.Anzai	Refer to Revision Record on page 2.				
Rev	DATE	DESIG.	CHECK	APPR.	DESCRIPTION	PFU LIMITED		PAGE	89/138
DESIG	Aug.19, 2005	K.Okada	CHECK	K.Okada	APPR. T.Anzai				

4-10-7. Replacing the Pick Motor

NOTICE

As the dust-proof area in the scanner is opened by the following procedure, do not replace the following parts in a dusty room.

Refer to [Section 6-11](#) for the part number of the replacement part.

<Removing>

(1) Remove Chute unit (ADF paper chute), Stacker unit, PCB unit, Rear cover, Upper cover and Guide A ASSY by referring to Sections from [4-7-1](#) to [4-7-6](#).

(2) Remove the Dust cover by referring to [Section 4-10-3](#).

(3) Remove two motor cables that run on the backside of the scanner from a hole of chassis and all hooks.

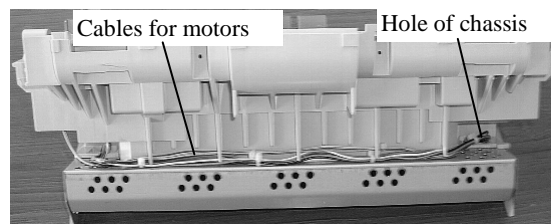

(4) Remove two screws from PICK Motor, and remove the motor.

Reference: PICK Motor includes the cable, gears and bracket with shafts.

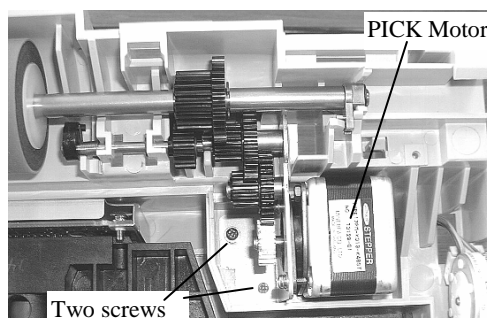

<Mounting>

Follow the removing procedure in reverse.

(1) Align the shaft and tab of the bracket with the slot and square hole of the frame respectively.

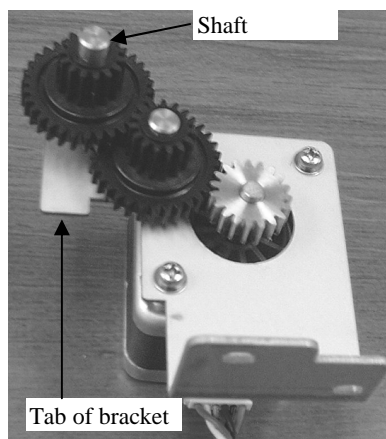

(2) When routing the motor cable on backside of the scanner, insert thinner cable first to avoid cables come out the hooks.

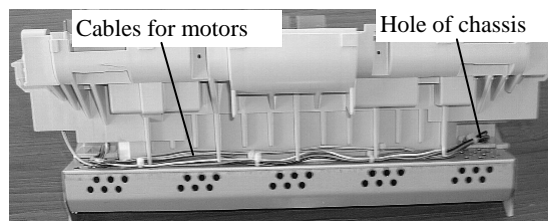

05	Nov. 20, 2008	K.Okada	T.Anzai	I.Fujioka	Refer to Revision Record on page 2.	TITLE fi-5530C/fi-5530C2 IMAGE SCANNER MAINTENANCE MANUAL	DRAW. No. P1PA03334-B30X/6	CUST.
04	July 7, 2008	K.Okada	T.Anzai	I.Fujioka	Refer to Revision Record on page 2.			
03	Feb.23, 2007	K.Okada	K.Okada	T.Anzai	Refer to Revision Record on page 2.			
Rev	DATE	DESIG.	CHECK	APPR.	DESCRIPTION	PFU LIMITED	PAGE	90/138
DESIG	Aug.19, 2005	K.Okada	CHECK	K.Okada	APPR. T.Anzai			

4-10-8. Replacing the BW Motor

NOTICE

As the dust-proof area in the scanner is opened by the following procedure, do not replace the following parts in a dusty room.

Refer to [Section 6-13](#) for the part number of the replacement part.

<Removing>

(1) Remove Chute unit (ADF paper chute), Stacker unit, PCB unit, Rear cover, Upper cover and Guide A ASSY by referring to Sections from [4-7-1](#) to [4-7-6](#).

(2) Remove the Dust cover by referring to [Section 4-10-3](#).

(3) Remove two motor cables that run on the backside of the scanner from a hole of chassis and all hooks.

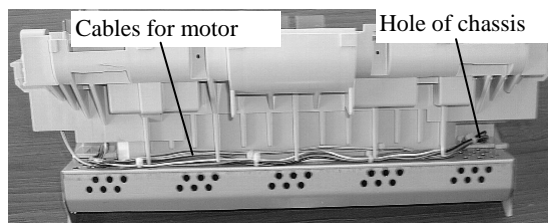

(4) Remove two screws that are fixing the BW motor. Slide the motor inside and tilt it to remove the motor from the Upper unit.

Reference: BW motor includes the cable.

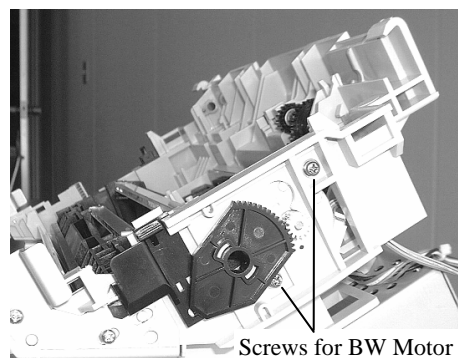

<Mounting>

Follow the removing procedure in reverse.

(1) Fix the motor so that the connector of the cable shall be located in lower side.

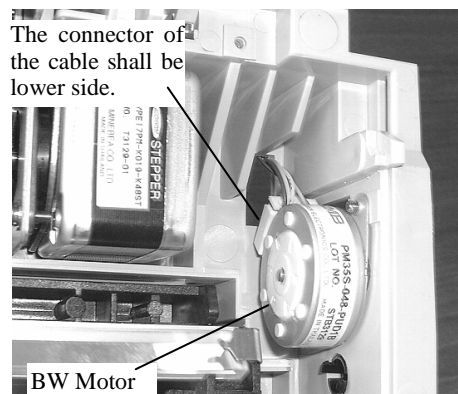

(2) When routing the motor cable on backside of the scanner, insert thinner cable first to avoid cables come out the hooks.

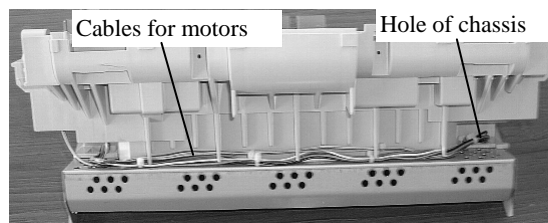

05	Nov. 20, 2008	K.Okada	T.Anzai	I.Fujioka	Refer to Revision Record on page 2.	TITLE fi-5530C/fi-5530C2 IMAGE SCANNER MAINTENANCE MANUAL	DRAW. No. P1PA03334-B30X/6	CUST.
04	July 7, 2008	K.Okada	T.Anzai	I.Fujioka	Refer to Revision Record on page 2.			
03	Feb.23, 2007	K.Okada	K.Okada	T.Anzai	Refer to Revision Record on page 2.			
Rev	DATE	DESIG.	CHECK	APPR.	DESCRIPTION	PFU LIMITED	PAGE	91/138
DESIG	Aug.19, 2005	K.Okada	CHECK	K.Okada	APPR. T.Anzai			

4-11. Replacing the Control PCA

Refer to [Section 6-23](#) for the part number of the replacement part.

<Removing>

- (1) Remove the PCB Unit. (Refer to the procedure in [Section 4-7-3](#).)
- (2) Remove 5 screws that fix the Control PCA and 3 screws that fix the connectors to take out the Control PCA.

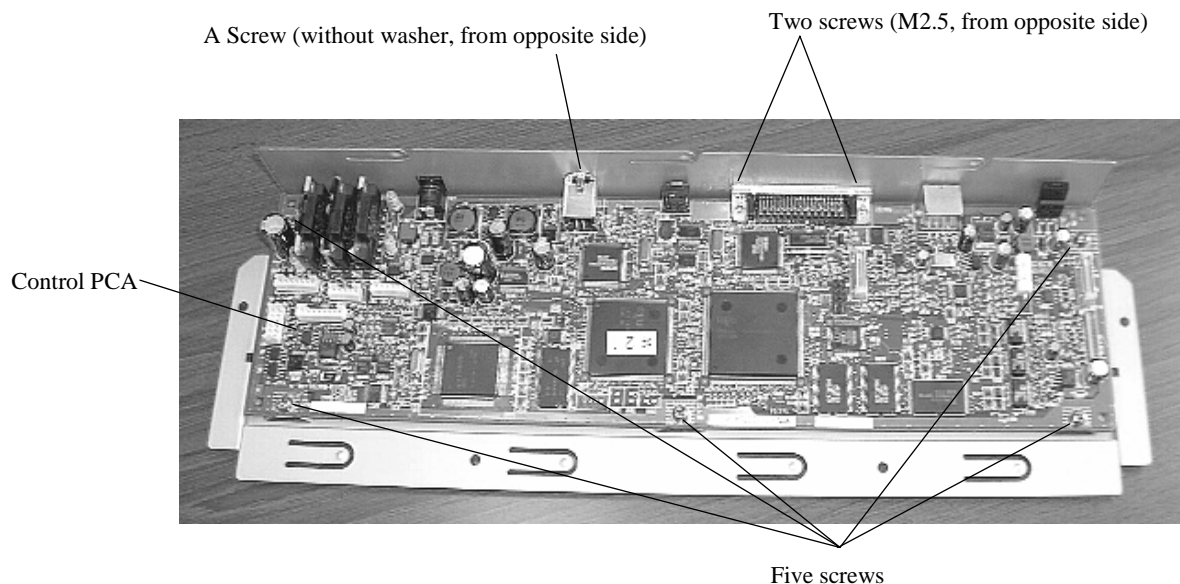

<Mounting>

Follow the removing procedure in reverse. When connecting the connectors, refer to the notice in [Section 4-7-3](#).

05	Nov. 20, 2008	K.Okada	T.Anzai	I.Fujioka	Refer to Revision Record on page 2.	TITLE fi-5530C/fi-5530C2 IMAGE SCANNER MAINTENANCE MANUAL	DRAW. No. P1PA03334-B30X/6	CUST.
04	July 7, 2008	K.Okada	T.Anzai	I.Fujioka	Refer to Revision Record on page 2.			
03	Feb.23, 2007	K.Okada	K.Okada	T.Anzai	Refer to Revision Record on page 2.			
Rev	DATE	DESIG.	CHECK	APPR.	DESCRIPTION	PFU LIMITED	PAGE	92/138
DESIG	Aug.19, 2005	K.Okada	CHECK	K.Okada	APPR. T.Anzai			

Chapter 5 Adjustment/Settings

5-1 Maintenance mode

The scanner supports built-in Maintenance mode that allows users to check scanner's performance and settings. This section gives the description of Maintenance mode.

5-1-1 Activating the Maintenance mode

(1) How to activate the Maintenance mode

Open the ADF. Press the power button once while pressing down **Scan** button. Keep pressing **Scan** button until Screen T02 is displayed. This will put the scanner into Maintenance mode. While in Maintenance mode, the scanner interface is off-line.

The following display appears during power up processing in Maintenance mode.

Screen T01

Function No. Display	Power LED	Scanner status
	ON	Initial processing in Maintenance mode

When Maintenance mode is activated normally after the initial processing, the following display appears.

Screen T02

Function No. Display	Power LED	Scanner status
	ON	Maintenance mode #1 selected

(2) Test/adjustment items of the Maintenance mode

The following lists test/adjustment items #1 ~ #7 that are supported by the scanner.

- Mode #1: Paper transportation test and Sensor test
- Mode #2: Main scanning/Sub-scanning magnification adjustment
- Mode #3: Offset adjustment
- Mode #4: White level adjustment
- Mode #5: Consumables counter display and reset
- Mode #6: Miscellaneous information display
- Mode #7: EEPROM data restore

05	Nov. 20, 2008	K.Okada	T.Anzai	I.Fujioka	Refer to Revision Record on page 2.	TITLE	fi-5530C/fi-5530C2 IMAGE SCANNER MAINTENANCE MANUAL		
04	July 7, 2008	K.Okada	T.Anzai	I.Fujioka	Refer to Revision Record on page 2.				
03	Feb.23, 2007	K.Okada	K.Okada	T.Anzai	Refer to Revision Record on page 2.				
						DRAW. No.	P1PA03334-B30X/6		CUST.
Rev	DATE	DESIG.	CHECK	APPR.	DESCRIPTION	PFU LIMITED		PAGE	93/138
DESIG	Aug.19, 2005	K.Okada	CHECK	K.Okada	APPR. T.Anzai				

(3) Changing Maintenance mode

To change Maintenance modes (#1 ~ #7), press the **Function** button on the activation screen for Maintenance mode. The display changes as follows. Mode #1 is the default mode.

Maintenance mode No.	Display			Maintenance mode	Related section
	Function No. Display	Power LED	Status transition		
#1		ON		Paper transportation test, Sensor test and Background changeover unit test	5-1-2
#2		ON		Main-scanning/ Sub-scanning magnification adjustment	5-1-3
#3		ON		Offset adjustment	5-1-4
#4		ON		White level adjustment	5-1-5
#5		ON		Consumables counter display and reset	5-1-6
#6		ON		Miscellaneous information display	5-1-7
#7		ON		EEPROM data restore	5-1-7
#8		ON		(Reserved) Press Function key to return to #1.	

(4) Starting the Maintenance mode

Select one Maintenance mode and press the **Scan** button. The scanner activates the selected Maintenance mode.

05	Nov. 20, 2008	K.Okada	T.Anzai	I.Fujioka	Refer to Revision Record on page 2.	TITLE	fi-5530C/fi-5530C2 IMAGE SCANNER MAINTENANCE MANUAL		
04	July 7, 2008	K.Okada	T.Anzai	I.Fujioka	Refer to Revision Record on page 2.				
03	Feb.23, 2007	K.Okada	K.Okada	T.Anzai	Refer to Revision Record on page 2.				
						DRAW. No.	P1PA03334-B30X/6		CUST.
Rev	DATE	DESIG.	CHECK	APPR.	DESCRIPTION	PFU LIMITED		PAGE	94/138
DESIG	Aug.19, 2005	K.Okada	CHECK	K.Okada	APPR. T.Anzai				

5-1-2 Maintenance mode #1: Paper feeding test / Sensor test / Background changeover test

This mode tests the ADF paper feeding operation at the specified speed, checks each sensor status (ON/OFF) of the ADF sensors, and tests background changeover.

[How to start]

- (1) From screen T04, press the Function (or) button to select  (Maintenance mode #1) and press the Scan button. The selection screen for scanning speed/sensor/Background changeover test appears. A number is shown on the Function No. Display indicating the selected scanning speed or test mode as follows.

Function No. Display	Scanning speed/test mode	Remarks
0	Monochrome 400 dpi	Default
1	Monochrome 300 dpi	
2	Monochrome 240 dpi	
3	Monochrome 200 dpi	
4	Monochrome 100 dpi	
5	Monochrome 150 dpi	
6	Monochrome 600 dpi	
7	Sensor test	
8	Background changeover test	

<Paper feeding test>

- (2) Select a scanning speed from 0 to 6 (this varies depending on the scanning resolution) from 0 ~ 6 by pressing the **Function** button.

When the Imprinter option is NOT connected:

- (3) To test the continuous feeding operation, press the **Scan** button. The ADF operation is started if any paper on the ADF paper chute (Chute unit) (Hopper empty sensor = Sensor EM ON).
To test the one-sheet feeding operation, while pressing the **Send to** button, press the **Scan** button, which switches to the one-sheet feeding operation mode. Then let go of the **Send to** button, then the **Scan** button in order. The ADF operation is started if any paper on the ADF paper chute (Chute unit) (Hopper empty sensor = Sensor EM ON).

When the Imprinter option is connected:

- (3) To test the continuous feeding operation, press the **Scan** button. The function number display requires selecting whether imprinting is necessary or not.
 To switch to imprinting mode, press the **Function** button to change the display to "P". (Refer to step (4) in the next page.) **04**

To test the one-sheet feeding operation, while pressing the **Send to** button, press the **Scan** button, which switches to the one-sheet feeding operation mode. Then let go of the **Send to** button, then the **Scan** button in order. The function number display requires selecting whether imprinting is necessary or not.

Function number display	Mode	Remarks
-	NO imprinting	Default (Screen T11)
P	Imprinting	Screen T12

05	Nov. 20, 2008	K.Okada	T.Anzai	I.Fujioka	Refer to Revision Record on page 2.	TITLE	fi-5530C/fi-5530C2 IMAGE SCANNER MAINTENANCE MANUAL		
04	July 7, 2008	K.Okada	T.Anzai	I.Fujioka	Refer to Revision Record on page 2.				
03	Feb.23, 2007	K.Okada	K.Okada	T.Anzai	Refer to Revision Record on page 2.				
						DRAW. No.	P1PA03334-B30X/6		CUST.
Rev	DATE	DESIG.	CHECK	APPR.	DESCRIPTION	PFU LIMITED		PAGE	95/138
DESIG	Aug.19, 2005	K.Okada	CHECK	K.Okada	APPR.				

- (4) Select whether imprinting is necessary or not by pressing the **Function** button.

Screen T11

Function No. display	Scanner status
	“-” lights without blinking. NO imprinting (default)

Screen T12

Function No. display	Scanner status
	“P” lights without blinking. Imprinting

<Available buttons at Screen T11 and T12>

Function button: Switches between Screens T11 and T12 every press.

Send to button: Terminates this mode and returns to Screen T04.

- (5) Press the **Scan** button. The ADF operation is started if any paper on the ADF paper chute (Chute unit) (Hopper empty sensor = Sensor EM ON).

<Sensor test>

- (2) By pressing the **Scan** button while “7” is shown on the display, the scanner enters Sensor test mode. The following table shows how the sensor status is displayed while the sensor test is in progress.

Screen T13

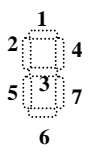
Function No. Display	Description	Display
	1: indicates Imprinter (option) document detection sensor (Sensor) status	Illuminates when the sensor is ON (Paper is detected)
	2: indicates Hopper empty sensor (Sensor EM) status	Illuminates when the sensor is ON (Paper is loaded on the ADF chute)
	3: indicates Sensor Pick status	Illuminates when the sensor is ON (Paper is detected)
	4: indicates Sensor TOP status	Illuminates when the sensor is ON (Paper is detected)
	5: indicates Cover open sensor status	Illuminates when the sensor is OFF (Cover is open) *1
	6: indicates Imprinter (option) printing section status (open/close)	Illuminates when the sensor is OFF (Printing section is open)
	7: indicates Multi feed sensor (US Sensor) status	Illuminates when the sensor is ON (Paper is detected) *2

*1: This sensor test should be conducted by opening/closing the ADF cover. If the Cover open sensor is pressed by anything while the ADF cover is open, the Multi feed sensor (US Sensor) turns ON, causing position “7” to light as well.

*2: The confirmation of US sensor is available only when the document is fed by pressing the **Function** button as described below. You cannot confirm US sensor by just inserting document (no feeding) between US sensors.

During the sensor test, you can check the sensor status (ON/OFF) when the document passes through the ADF by the following procedure:

1. Press the **Function** button. The PICK Motor and LF Motor start to rotate.
2. Set the document into the ADF paper chute (Chute unit).

<Background changeover test>

- (2) By pressing the **Scan** button while “8” is shown on the display, the scanner starts Background changeover test. The testing is confirmed by opening the ADF.

[How to end]

Press the **Send to** button. The test stops and the Maintenance mode selection Screen T04 appears. The ADF continuous feeding operation is also terminated when no more paper on the ADF paper chute (Chute unit).

05	Nov. 20, 2008	K.Okada	T.Anzai	I.Fujioka	Refer to Revision Record on page 2.	TITLE	fi-5530C/fi-5530C2 IMAGE SCANNER MAINTENANCE MANUAL		
04	July 7, 2008	K.Okada	T.Anzai	I.Fujioka	Refer to Revision Record on page 2.				
03	Feb.23, 2007	K.Okada	K.Okada	T.Anzai	Refer to Revision Record on page 2.				
						DRAW. No.	P1PA03334-B30X/6		CUST.
Rev	DATE	DESIG.	CHECK	APPR.	DESCRIPTION	PFU LIMITED		PAGE	96/138
DESIG	Aug.19, 2005	K.Okada	CHECK	K.Okada	APPR. T.Anzai				

5-1-3 Maintenance mode #2: Main scanning / Sub-scanning magnification adjustment

In this mode, the magnification correction values for main/sub scanning are automatically calculated to satisfy the following adjustment value.

Adjustment value

Main scanning: Within $\pm 1.0\%$

Sub scanning: Within $\pm 1.0\%$ (Without stop and start during scanning)

: Within $\pm 2.0\%$ (With stop and start during scanning)

NOTICE

Before this adjustment, please prepare the A3-size white sheet described in Figure 5-1-3.

[How to start]

- (1) Select  (Maintenance mode #2) by pressing **Function** button at screen T04, and then press **Scan** button. The scanner shows a number that is currently selected adjustment area. The number indicates the area of magnification adjustment as follows.

Function No. Display	Magnification to be adjusted	Remarks
0	ADF sub- scanning magnification adjustment	Default
1	ADF main scanning magnification adjustment (front)	
2	ADF main scanning magnification adjustment (back)	

- (2) Select the magnification you want to change by pressing **Function** button.

- (3) Set the adjustment test sheet on the Chute unit (ADF paper chute), and adjust the side guide to the width of the test sheet. Set the test sheet facing down on the Chute unit (ADF paper chute) for the ADF front adjustment, and facing up for the ADF back adjustment. Press **Scan** button to start the adjustment.

[How to end]

Press **Send to** button during operation. The operation stops and the Maintenance mode selection Screen T04 appears.

05	Nov. 20, 2008	K.Okada	T.Anzai	I.Fujioka	Refer to Revision Record on page 2.	TITLE fi-5530C/fi-5530C2 IMAGE SCANNER MAINTENANCE MANUAL	DRAW. No. P1PA03334-B30X/6	CUST.
04	July 7, 2008	K.Okada	T.Anzai	I.Fujioka	Refer to Revision Record on page 2.			
03	Feb.23, 2007	K.Okada	K.Okada	T.Anzai	Refer to Revision Record on page 2.			
Rev	DATE	DESIG.	CHECK	APPR.	DESCRIPTION	PFU LIMITED	PAGE	97/138
DESIG	Aug.19, 2005	K.Okada	CHECK	K.Okada	APPR. T.Anzai			

[Display after adjustment]

After the magnification adjustment, the following display appears depending on its terminated status.

(4) When the magnification adjustment is terminated normally

Screen T21

Function No. Display	Scanner status
	Displays "o" without blinking. The adjustment has terminated normally.

<Available buttons at Screen T21>

Function button: Displays Screen T22 to write the correction value into EEPROM.

Send to button: Terminates this mode and returns to Screen T04.

Screen T22

Function No. Display	Scanner status
	"o" (down half) blinks. Confirming whether the correction value shall be written in EEPROM or not.

<Available buttons at Screen T22>

Scan + **Function** button: Start writing the magnification correction value into EEPROM. During writing operation, Screen T23 displayed, and when it finishes, Screen T24 appears.

Send to button: Terminates this mode and returns to Screen T04.

Screen T23

Function No. Display	Scanner status
	"L" (upper half) lights without blinking. Correction value is being written in EEPROM.

Note: While Screen T23 is displayed, no button can function.

Screen T24

Function No. Display	Scanner status
	"o" (upper half) lights without blinking. The value has written normally.

<Available buttons at Screen T24>

Send to button: Terminates this mode and returns to Screen T04.

05	Nov. 20, 2008	K.Okada	T.Anzai	I.Fujioka	Refer to Revision Record on page 2.	TITLE fi-5530C/fi-5530C2 IMAGE SCANNER MAINTENANCE MANUAL	DRAW. No. P1PA03334-B30X/6	CUST.
04	July 7, 2008	K.Okada	T.Anzai	I.Fujioka	Refer to Revision Record on page 2.			
03	Feb.23, 2007	K.Okada	K.Okada	T.Anzai	Refer to Revision Record on page 2.			
Rev	DATE	DESIG.	CHECK	APPR.	DESCRIPTION	PFU LIMITED	PAGE	98/138
DESIG	Aug.19, 2005	K.Okada	CHECK	K.Okada	APPR. T.Anzai			

(5) When the magnification adjustment is terminated abnormally

Screen T25

Function No. Display	Scanner status
	Displays "c" without blinking. The adjustment has terminated abnormally.

Note: The major reason of abnormal termination is incorrect setting of the test sheet. Set the test sheet correctly and try the magnification adjustment again.

<Available buttons at Screen T25>

Function button: Displays error information (Screen T26)

Send to button: Terminates this mode and returns to Screen T04.

Screen T26

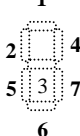
Function No. Display	Description	Adjustment mode (*1)		Countermeasure when abnormal termination frequently occurs
		0	1,2	
	1: cannot detect the leading edge of the document	√		Conduct necessary operation by referring to Section 3-3-7 or procedure (2) and later in Section 3-3-10 .
	2: cannot detect the left edge of the document		√	
	4: cannot detect the right edge of the document		√	
	5: Large skew A		√	
	6: cannot detect the trailing edge of the document	√		
	7: Large skew B		√	

(*1) 0 : ADF sub scanning magnification adjustment

1,2: ADF front/back main scanning magnification adjustment

Skew A and B are calculated as follows:

$$\text{Skew A} = a - b$$

$$\text{Skew B} = c - d$$

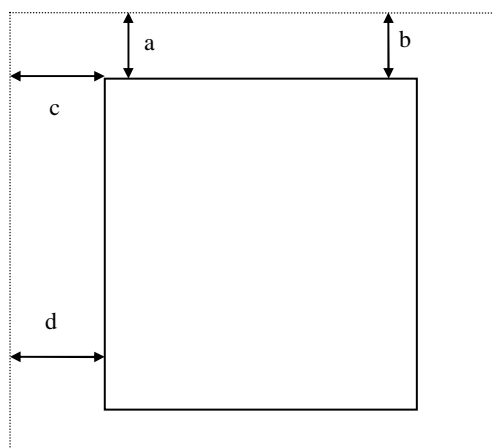

<Available buttons at screen T26>

Send to button: Terminates this mode and returns to Screen T04.

05	Nov. 20, 2008	K.Okada	T.Anzai	I.Fujioka	Refer to Revision Record on page 2.	TITLE fi-5530C/fi-5530C2 IMAGE SCANNER MAINTENANCE MANUAL	DRAW. No. P1PA03334-B30X/6	CUST.
04	July 7, 2008	K.Okada	T.Anzai	I.Fujioka	Refer to Revision Record on page 2.			
03	Feb. 23, 2007	K.Okada	K.Okada	T.Anzai	Refer to Revision Record on page 2.			
Rev	DATE	DESIG.	CHECK	APPR.	DESCRIPTION	PFU LIMITED		PAGE 99/138
DESIG	Aug.19, 2005	K.Okada	CHECK	K.Okada	APPR. T.Anzai			

[Test sheet]

Use the test sheet for the magnification/offset adjustment that meets the following specification.

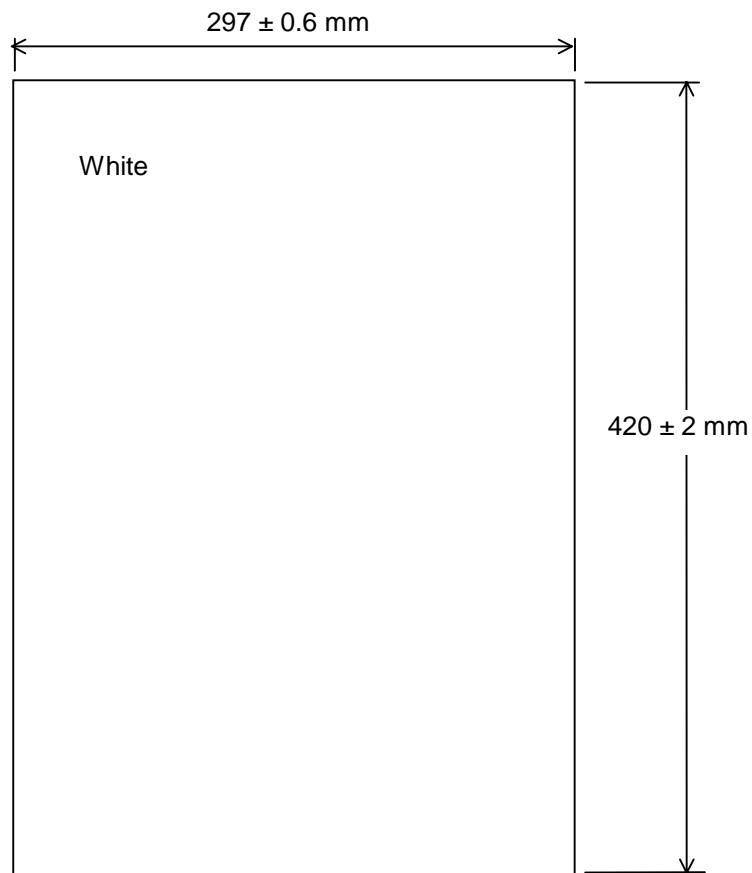

Figure 5-1-3. Test sheet for the magnification/offset adjustment

05	Nov. 20, 2008	K.Okada	T.Anzai	I.Fujioka	Refer to Revision Record on page 2.	TITLE fi-5530C/fi-5530C2 IMAGE SCANNER MAINTENANCE MANUAL	DRAW. No. P1PA03334-B30X/6	CUST.
04	July 7, 2008	K.Okada	T.Anzai	I.Fujioka	Refer to Revision Record on page 2.			
03	Feb.23, 2007	K.Okada	K.Okada	T.Anzai	Refer to Revision Record on page 2.			
Rev	DATE	DESIG.	CHECK	APPR.	DESCRIPTION	PFU LIMITED	PAGE	100/138
DESIG	Aug.19, 2005	K.Okada	CHECK	K.Okada	APPR. T.Anzai			

5-1-4 Maintenance mode #3 : Offset adjustment

In this mode, the offset correction values for main/sub scanning are automatically calculated to satisfy the following offset values:

Offset value

Main scanning: The largest offset of A6 – A4 size of document shall be: ± 24 dot (@600dpi)

Sub scanning: The largest offset of A6 – A4 size of document shall be: ± 33 dot (@600dpi)

NOTICE

Before this adjustment, please prepare the Test sheet described in Figure 5-1-3.

[How to start]

- (1) Select  (Maintenance mode #3) by pressing **Function** button at Screen T04, and then press **Scan** button. The scanner shows a number that is currently selected area of adjustment. The number indicates the area of offset adjustment as follows.

Function No. Display	Offset to be adjusted	Remarks
0	ADF front	Default
1	ADF back	

- (2) Change the selection by pressing **Function** button.
- (3) Set the test sheet (see Figure 5-1-3) on the Chute unit (ADF paper chute), and adjust the side guide to the width of the test sheet.

[How to end]

Press **Send to** button during operation. The operation stops and the Maintenance mode selection Screen (T04) appears.

05	Nov. 20, 2008	K.Okada	T.Anzai	I.Fujioka	Refer to Revision Record on page 2.	TITLE fi-5530C/fi-5530C2 IMAGE SCANNER MAINTENANCE MANUAL	DRAW. No. P1PA03334-B30X/6	CUST.
04	July 7, 2008	K.Okada	T.Anzai	I.Fujioka	Refer to Revision Record on page 2.			
03	Feb.23, 2007	K.Okada	K.Okada	T.Anzai	Refer to Revision Record on page 2.			
Rev	DATE	DESIG.	CHECK	APPR.	DESCRIPTION	PFU LIMITED	PAGE	101/138
DESIG	Aug.19, 2005	K.Okada	CHECK	K.Okada	APPR. T.Anzai			

[Display after adjustment]

After the offset adjustment, the following display appears depending on its terminated status.

(4) When the offset adjustment is terminated normally

Screen T31

Function No. Display	Scanner status
	Displays "o" without blinking. The adjustment has terminated normally.

<Available buttons at Screen T31>

Function button: Displays Screen T32 to write the correction value into EEPROM.

Send to button: Terminates this mode and return to Screen T04.

Screen T32

Function No. Display	Scanner status
	"o" (down half) blinks. Confirming whether the correction value shall be written in EEPROM or not.

<Available buttons at Screen T32>

Scan + **Function** button: Starts writing the offset correction value into EEPROM. During writing operation, Screen T33 displayed, and when it finishes, Screen T34 appears.

Send to button: Terminates this mode and returns to Screen T04.

Screen T33

Function No. Display	Scanner status
	"L" (upper half) lights without blinking. Correction value is being written in EEPROM.

Note: While Screen T33 is displayed, no button can function.

Screen T34

Function No. Display	Scanner status
	"o" (upper half) lights without blinking. The value has written normally.

<Available buttons at Screen T34>

Send to button: Terminates this mode and returns to Screen T04

05	Nov. 20, 2008	K.Okada	T.Anzai	I.Fujioka	Refer to Revision Record on page 2.	TITLE	fi-5530C/fi-5530C2 IMAGE SCANNER MAINTENANCE MANUAL		
04	July 7, 2008	K.Okada	T.Anzai	I.Fujioka	Refer to Revision Record on page 2.				
03	Feb.23, 2007	K.Okada	K.Okada	T.Anzai	Refer to Revision Record on page 2.				
						DRAW. No.	P1PA03334-B30X/6		CUST.
Rev	DATE	DESIG.	CHECK	APPR.	DESCRIPTION	PFU LIMITED		PAGE	102/138
DESIG	Aug.19, 2005	K.Okada	CHECK	K.Okada	APPR. T.Anzai				

(5) When the offset adjustment is terminated abnormally

Screen T35

Function No. Display	Scanner status
	Displays "c" without blinking. The adjustment has terminated abnormally.

Note: The major reason of abnormal termination is incorrect setting of the test sheet. Set the test sheet correctly and try the magnification adjustment again.

<Available buttons at Screen T35>

Function button: Displays error information (Screen T36)

Send to button: Terminates this mode and returns to Screen T04.

Screen T36

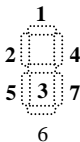
Function No. Display	Description	Adjustment mode (*1)		Countermeasure when abnormal termination frequently occurs
		0	1,2	
	1: cannot detect the leading edge of the document (black detection failed)	√	√	Conduct necessary operation by referring to Section 3-3-6 or procedure (2) and later in Section 3-3-9 .
	2: cannot detect the left edge of the document (black detection failed)	√	√	
	3: cannot detect the leading edge of the document (white detection failed)	√	√	
	5: cannot detect the left edge of the document (white detection failed)	√	√	
	4: Large skew A	√	√	
	7: Large skew B	√	√	
	6			

(*1) 0 : ADF front

1,2: ADF back

<Available buttons at screen T36>

Send to button: Terminates this mode and returns to Screen T04.

Skew A and B are calculated by the following expression.

Skew A = a - b

Skew B = c - d

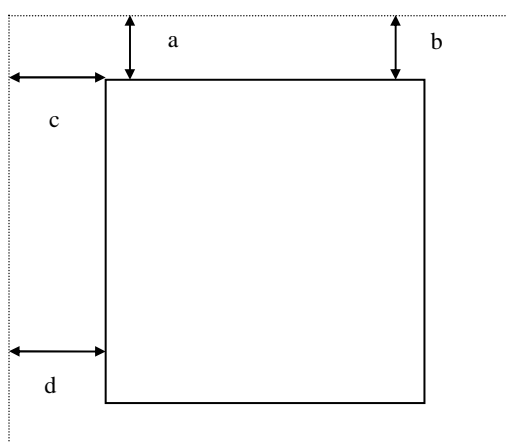

[Test sheet]

Use the same sheet as used for the magnification adjustment. See [Section 5-1-3](#), Figure 5-1-3.

05	Nov. 20, 2008	K.Okada	T.Anzai	I.Fujioka	Refer to Revision Record on page 2.	TITLE fi-5530C/fi-5530C2 IMAGE SCANNER MAINTENANCE MANUAL	DRAW. No. P1PA03334-B30X/6	CUST.
04	July 7, 2008	K.Okada	T.Anzai	I.Fujioka	Refer to Revision Record on page 2.			
03	Feb.23, 2007	K.Okada	K.Okada	T.Anzai	Refer to Revision Record on page 2.			
Rev	DATE	DESIG.	CHECK	APPR.	DESCRIPTION	PFU LIMITED	PAGE	103/138
DESIG	Aug.19, 2005	K.Okada	CHECK	K.Okada	APPR. T.Anzai			

5-1-5 Maintenance mode #4: White level adjustment

In this mode, the white level correction values for main/sub scanning are automatically adjusted.

NOTICE

Before this adjustment, please prepare the Test sheet described in [Section 4-4](#).

[How to start]

- (1) Select  (Maintenance mode #4) by pressing **Function** button at Screen T04, and then press **Scan** button. The scanner shows a number that is currently selected area of adjustment. The number indicates the area of White level adjustment as follows.

Function No. Display	White level to be adjusted	Remarks
0	ADF front	Default
1	ADF back	

- (2) Change the selection by pressing **Function** button.

- (3) When adjusting the ADF, set the adjustment test sheet on the Chute unit (ADF paper chute) in landscape, and adjust the side guide to the width of the test sheet. Either side of the adjustment test sheet can be used. Press **Scan** button to start the adjustment operation.

Note: The adjustment starts approx. 10 seconds after pressing **Scan** button to make the light intensity becomes stable.

[How to end]

Press **Send to** button during operation. The operation stops and the Maintenance mode selection Screen T04 appears.

Note: After reading the white level adjustment sheet, it takes approx. 10 seconds for the scanner to calculate the level adjustment and close adjustment.

05	Nov. 20, 2008	K.Okada	T.Anzai	I.Fujioka	Refer to Revision Record on page 2.	TITLE	fi-5530C/fi-5530C2 IMAGE SCANNER MAINTENANCE MANUAL		
04	July 7, 2008	K.Okada	T.Anzai	I.Fujioka	Refer to Revision Record on page 2.				
03	Feb.23, 2007	K.Okada	K.Okada	T.Anzai	Refer to Revision Record on page 2.				
						DRAW. No.	P1PA03334-B30X/6	CUST.	
Rev	DATE	DESIG.	CHECK	APPR.	DESCRIPTION	PFU LIMITED		PAGE	104/138
DESIG	Aug.19, 2005	K.Okada	CHECK	K.Okada	APPR. T.Anzai				

[Display after adjustment]

After the white level adjustment, the following display appears depending on its terminated status.

(4) When the white level adjustment is terminated normally

Screen T41

Function No. Display	Scanner status
	Displays "o" (down half) without blinking. The adjustment has terminated normally.

<Available buttons at Screen T41>

Function button: Displays screen T42 to write the correction value into EEPROM.

Send to button: Terminates this mode and returns to Screen T04.

Screen T42

Function No. Display	Scanner status
	"o" (down half) blinks. Confirming whether the correction value shall be written in EEPROM or not.

<Available buttons at Screen T42>

Scan + **Function** button: Start writing the white level correction value into EEPROM. During writing operation, screen T43 displayed, and when it finishes, screen T44 appears

Send to button: Terminates this mode and returns to Screen T04.

Screen T43

Function No. Display	Scanner status
	"L" (upper half) lights without blinking. Correction value is being written in EEPROM.

Note: While Screen T43 is displayed, no button can function.

Screen T44

Function No. Display	Scanner status
	"o" (upper half) lights without blinking. The value has written normally.

<Available buttons at Screen T44>

Send to button: Terminates this mode and returns to Screen T04.

05	Nov. 20, 2008	K.Okada	T.Anzai	IFujioka	Refer to Revision Record on page 2.	TITLE fi-5530C/fi-5530C2 IMAGE SCANNER MAINTENANCE MANUAL	DRAW. No. P1PA03334-B30X/6	CUST.
04	July 7, 2008	K.Okada	T.Anzai	IFujioka	Refer to Revision Record on page 2.			
03	Feb.23, 2007	K.Okada	K.Okada	T.Anzai	Refer to Revision Record on page 2.			
Rev	DATE	DESIG.	CHECK	APPR.	DESCRIPTION	PFU LIMITED	PAGE	105/138
DESIG	Aug.19, 2005	K.Okada	CHECK	K.Okada	APPR. T.Anzai			

(5) When the white level adjustment is terminated abnormally

Screen T45

Function No. Display	Scanner status
	Displays "c". The adjustment has terminated abnormally.

Note: The major reason of abnormal termination is incorrect setting of the test sheet. Set the test sheet correctly and try the magnification adjustment again.

<Available buttons at Screen T45>

Function button: Displays error information (Screen T46)

Send to button: Terminates this mode and returns to Screen T04.

Screen T46

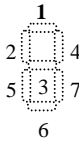
Function No. Display	Description	Countermeasure when abnormal termination frequently occurs
	1: media error The tested sheet may not be a specified one. Please confirm the test sheet is good.	It seems Lamp or Optical unit is faulty. Replace defective parts.

<Available buttons at Screen T46>

Send to button: Terminates this mode and return to Screen T04.

05	Nov. 20, 2008	K.Okada	T.Anzai	I.Fujioka	Refer to Revision Record on page 2.	TITLE	fi-5530C/fi-5530C2 IMAGE SCANNER MAINTENANCE MANUAL		
04	July 7, 2008	K.Okada	T.Anzai	I.Fujioka	Refer to Revision Record on page 2.				
03	Feb.23, 2007	K.Okada	K.Okada	T.Anzai	Refer to Revision Record on page 2.				
						DRAW. No.	P1PA03334-B30X/6		CUST.
Rev	DATE	DESIG.	CHECK	APPR.	DESCRIPTION	PFU LIMITED		PAGE	106/138
DESIG	Aug.19, 2005	K.Okada	CHECK	K.Okada	APPR. T.Anzai				

5-1-6 Maintenance mode #5: Counter display and reset

In this mode, the following counters are displayed and reset:

- Pick counter (Abrasion counter for Pick roller)
- Pad counter (Abrasion counter for Pad ASSY)
- Remaining ink counter
- Roller kit counter for Imprinter

[How to operate]

- (1) Select  (Maintenance mode #5) by pressing **Function** button at Screen T04, and then press **Scan** button. The scanner shows a number that shows the current selection of the counter type. The number indicates the counter type as follows.

Function No. Display	Counter type	Remarks
0	Pick counter (Abrasion counter for Pick roller)	Default
1	Pad counter (Abrasion counter for Pad ASSY)	
2	(Reserved)	
3	Remaining Ink counter	
4	Roller kit counter for Imprinter	

- (2) Change the selection by pressing **Function** button.

- (3) The counter is displayed as follows when pressing **Scan** button.

Counter	Display
Pick counter (Abrasion counter for Pick roller)	The counter displays 8 digits in total, 1 number at a time, from left digit to right digit. If the counter has not reached 8 digits yet, 0 is added to blank digits. The symbol “-” is displayed before the first number to indicate the beginning of counter display. The counter displays “0” until it reaches 500, and increases the value in 10 increments after 500. e.g. When the counter is “16,245”, “-00016245” is displayed in the following order: “-” → “0” → “0” → “0” → “1” → “6” → “2” → “4” → “5”
Pad counter (Abrasion counter for Pad ASSY)	Display method is same as Pick counter above.
Remaining Ink counter	The counter displays 3 digits in total with the unit of %. Initial is 100%, and the value reduces as imprinter prints. Use this value as a reference, because ink consumption may vary widely depending on the printing condition.
Roller kit counter for Imprinter	Display method is same as Pick counter above. When Roller kit is replaced, this counter shall be reset.

05	Nov. 20, 2008	K.Okada	T.Anzai	I.Fujioka	Refer to Revision Record on page 2.	TITLE fi-5530C/fi-5530C2 IMAGE SCANNER MAINTENANCE MANUAL	DRAW. No. P1PA03334-B30X/6	CUST.
04	July 7, 2008	K.Okada	T.Anzai	I.Fujioka	Refer to Revision Record on page 2.			
03	Feb.23, 2007	K.Okada	K.Okada	T.Anzai	Refer to Revision Record on page 2.			
Rev	DATE	DESIG.	CHECK	APPR.	DESCRIPTION	PFU LIMITED	PAGE	107/138
DESIG	Aug.19, 2005	K.Okada	CHECK	K.Okada	APPR. T.Anzai			

(4) The following buttons are available during counter display.

- Function** button: Displays Screen T51 to reset the counter.
- Send to** button: Terminates this mode and returns to screen T04.

Screen T51

Function No. Display	Scanner status
	"o" (down half) blinks. Confirming whether the counter shall be reset or not.

<Available buttons at Screen T51>

Scan + **Function** button: Start resetting the displayed counter value to 0. During writing operation, Screen T52 displayed, and when it finishes, Screen T53 appears.

Note: After reset, the counter value below 500 remains without being reset and that value will be the initial value of the internal counter, but this is not an error.
 e.g.) When "52,168" is reset, 168 remains and the internal counter will start counting from 168, while Function No. Display shows 0.

Send to button: Terminates this mode and returns to Screen T04.

Screen T52

Function No. Display	Scanner status
	"L" (upper half) lights without blinking. The counter is being reset.

Note: While screen T52 is displayed, no button can function.

Screen T53

Function No. Display	Scanner status
	"o" (upper half) lights without blinking. Counter reset has done.

<Available buttons at Screen T53>

Send to button: Terminates this mode and returns to Screen T04.

05	Nov. 20, 2008	K.Okada	T.Anzai	I.Fujioka	Refer to Revision Record on page 2.	TITLE	fi-5530C/fi-5530C2 IMAGE SCANNER MAINTENANCE MANUAL		
04	July 7, 2008	K.Okada	T.Anzai	I.Fujioka	Refer to Revision Record on page 2.				
03	Feb.23, 2007	K.Okada	K.Okada	T.Anzai	Refer to Revision Record on page 2.				
						DRAW. No.	P1PA03334-B30X/6		CUST.
Rev	DATE	DESIG.	CHECK	APPR.	DESCRIPTION	PFU LIMITED		PAGE	108/138
DESIG	Aug.19, 2005	K.Okada	CHECK	K.Okada	APPR. T.Anzai				

5-1-7 Maintenance mode #6: Miscellaneous information display

In this mode, the following information counter is displayed:

- Firmware version number
- Starting date of the scanner *
- The accumulated number of paper that have been scanned by ADF
- Error/Alarm history

*: This indicates the date when the scanner is activated by the driver first. This information is only available if the driver supports this function.

[How to start]

- (1) Select  (Maintenance mode #6) by pressing **Function** button at Screen T04, and then press **Scan** button. The scanner shows a number that shows the current selection of information to display. The number indicates the information type as follows.

Function No. Display	Display	Remarks
0	Firmware version	Default
1	Starting date of the scanner	
2	The accumulated number of paper scanned by ADF	
3	(Reserved)	
4	Error/Alarm history	

- (2) Change the selection by pressing **Function** button.

- (3) The information is displayed as follows when pressing **Scan** button.

Information	Display
Firmware version number	The firmware version number is displayed in 4 digits from left digits to right digits, following the symbol “-“. e.g. When the version is “A00” (*1), “A” is converted to “01 ” (*2), so the scanner displays “-0100 ” in the following order: “-” → “0” → “1 ” → “0” → “0”
Starting date	Starting date of the scanner is displayed in 6 digits, 2 digits for “Year (Christian calendar)”, 2 digits for “Month”, and 2 digits for “Date”, following the symbol “-“. You cannot reset the date. e.g. When the starting date is January 31st, 2002, “020131” is displayed in the following order: “-” → “0” → “2” → 0 → “1” → “3” → “1”
The accumulated number of paper scanned by ADF	The accumulated number of paper scanned by ADF is displayed in 8 digits from left digits to right digits, following the symbol “-“.(If the counter does not reach 8 digits, 0 is added to blank digits.) The counter displays “0” until it reaches 500, and increases in 10 increments after 500. You cannot reset this counter. e.g. When the accumulated number is “16,245”, “00016245” is displayed in the following order: “-” → “0” → “0” → “0” → “1” → “6” → “2” → “4” → “5”

05	Nov. 20, 2008	K.Okada	T.Anzai	I.Fujioka	Refer to Revision Record on page 2.	TITLE fi-5530C/fi-5530C2 IMAGE SCANNER MAINTENANCE MANUAL	DRAW. No. P1PA03334-B30X/6	CUST.
04	July 7, 2008	K.Okada	T.Anzai	I.Fujioka	Refer to Revision Record on page 2.			
03	Feb.23, 2007	K.Okada	K.Okada	T.Anzai	Refer to Revision Record on page 2.			
Rev	DATE	DESIG.	CHECK	APPR.	DESCRIPTION	PFU LIMITED	PAGE	109/138
DESIG	Aug.19, 2005	K.Okada	CHECK	K.Okada	APPR. T.Anzai			

Information	Display
Error/Alarm history	<p>Latest three error types are displayed by this mode. Each error type is displayed by two digits as follows.</p> <p>Paper jam : 01 Multi feed : 02 Optical alarm (Front) : 12 Optical alarm (back) : 13 Motor fuse blown : 14 Imprinter fuse blown : 15 EEPROM alarm : 17 SCSI fuse blown : 18 SDRAM alarm : 19 Imprinter alarm : 1A Background changeover alarm : 1F Image transfer alarm : 20</p> <p>E.g. The case that following three error/alarm has occurred The latest: Paper jam Before the latest: Multi feed Before the above: Imprinter alarm</p> <p>The display sequence is; “.” → “0” → “1” → “_” → “0” → “2” → “_” → “1” → “A” The symbol “.” is a start mark. The symbol “_” is a separator of the information.</p>

*1: The firmware version is normally expressed by an alphabet, such as A, B or C

*2: As 8 segment display cannot display alphabet, alphabet is expressed by two digits as follows:

A	B	C	-----	J	K	L
01	02	03	-----	10	11	12

[How to end]

Press **Send to** button. The display returns to Screen T04.

05	Nov. 20, 2008	K.Okada	T.Anzai	IFujioka	Refer to Revision Record on page 2.	TITLE fi-5530C/fi-5530C2 IMAGE SCANNER MAINTENANCE MANUAL	DRAW. No. P1PA03334-B30X/6	CUST.
04	July 7, 2008	K.Okada	T.Anzai	IFujioka	Refer to Revision Record on page 2.			
03	Feb.23, 2007	K.Okada	K.Okada	T.Anzai	Refer to Revision Record on page 2.			
Rev	DATE	DESIG.	CHECK	APPR.	DESCRIPTION	PFU LIMITED	PAGE	110/138
DESIG	Aug.19, 2005	K.Okada	CHECK	K.Okada	APPR. T.Anzai			

5-1-8 Maintenance mode #7: EEPROM data restore

When replacing the Panel PCA, the EEPROM data on the Panel PCA shall be moved to the flash memory of the Control PCA. In this mode, the data is restored from the Control PCA to the Panel PCA.

[How to start]

- (1) Select  (Maintenance mode #7) by pressing **Function** button at Screen T04, and then press **Scan** button. The following display appears.

Screen T71

Function No. Display	Scanner status
	“o” (down half) blinks. Confirming whether the data shall be restored or not.

<Available buttons at Screen T71>

Scan + **Function** button: Returns the data from the Control PCA to the EEPROM on the Panel PCA. During restoring operation, Screen T72 is displayed. If the data restore terminates normally, Screen T73 appears. If no data exists in the Control PCA, Screen T74 appears.

Send to button: Terminates this mode and returns to Screen T04.

Screen T72

Function No. Display	Scanner status
	“L” (upper half) lights without blinking. The data is being restored.

Note: While Screen T72 is displayed, no button can function.

Screen T73

Function No. Display	Scanner status
	Displays “o” (upper half) without blinking. The data has restored normally.

<Available buttons at Screen T73>

Send to button: Terminates this mode and returns to Screen T04.

Screen T74

Function No. Display	Scanner status
	Displays “c” without blinking. No data exists in the Control PCA.

<Available buttons at Screen T74>

Send to button: Terminates this mode and returns to Screen T04.

05	Nov. 20, 2008	K.Okada	T.Anzai	I.Fujioka	Refer to Revision Record on page 2.	TITLE	fi-5530C/fi-5530C2 IMAGE SCANNER MAINTENANCE MANUAL		
04	July 7, 2008	K.Okada	T.Anzai	I.Fujioka	Refer to Revision Record on page 2.				
03	Feb.23, 2007	K.Okada	K.Okada	T.Anzai	Refer to Revision Record on page 2.				
						DRAW. No.	P1PA03334-B30X/6	CUST.	
Rev	DATE	DESIG.	CHECK	APPR.	DESCRIPTION	PFU LIMITED		PAGE	111/138
DESIG	Aug.19, 2005	K.Okada	CHECK	K.Okada	APPR. T.Anzai				

5-2 Saving EEPROM data

The EEPROM data on the Panel PCA can be saved in the flash memory on the Control PCA. This operation is required before replacing the Panel PCA. Since the Panel PCA does not work when replacing Panel PCA, EEPROM data saving is done without using operator panel by the following procedure.0

NOTICE

- Do not conduct this procedure unless the Panel PCA is malfunctioning.
- The Panel PCA from which the data was saved to the Control PCA cannot be used again.
- Make sure to prepare a new Panel PCA before saving the EEPROM data.

[How to save EEPROM data on the Control PCA]

1. Open the ADF. While pressing the lever of Sensor TOP and lifting up the lever of Sensor EM, power on the scanner. "P" → "H" are displayed.
2. Leave your fingers from the lever of Sensor TOP and Sensor EM. Then press the lever of Sensor TOP two times, so that the time interval between pressing and removing is more than 1 second.
3. Close the ADF. "L" is displayed, if the Function No. Display is working normally.
4. After more than 5 seconds elapse, open the ADF.

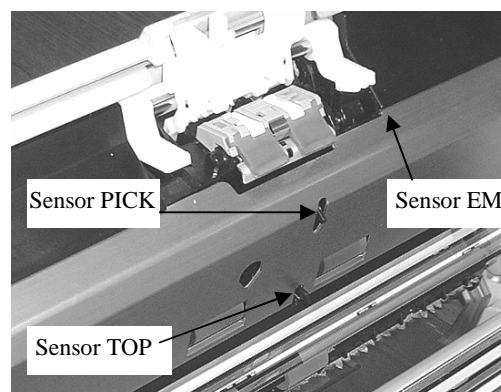

When the EEPROM data is successfully saved, the lamp of ADF front blinks 3 times, and "o" (upper half) is displayed on the Function No. Display.

In case that the EEPROM data is not successfully saved, the lamp does not blink, and "c" is displayed on the Function No. Display.

NOTICE

If EEPROM data is saved successfully, scanner writes some information on the Panel PCA, which disables the usage of the Panel PCA. So this Panel PCA cannot be used any more. The Panel PCA shall be replaced. If EEPROM data is not returned from Control PCA to new Panel PCA, "E" and "6" appear alternately on the operator panel at scanner power ON. So Restore EEPROM data by the procedure in [Section 5-1-8](#).

05	Nov. 20, 2008	K.Okada	T.Anzai	I.Fujioka	Refer to Revision Record on page 2.	TITLE	fi-5530C/fi-5530C2 IMAGE SCANNER MAINTENANCE MANUAL		
04	July 7, 2008	K.Okada	T.Anzai	I.Fujioka	Refer to Revision Record on page 2.				
03	Feb.23, 2007	K.Okada	K.Okada	T.Anzai	Refer to Revision Record on page 2.				
						DRAW. No.	P1PA03334-B30X/6		CUST.
Rev	DATE	DESIG.	CHECK	APPR.	DESCRIPTION	PFU LIMITED		PAGE	112/138
DESIG	Aug.19, 2005	K.Okada	CHECK	K.Okada	APPR.				

5-3 Emulation mode

The scanner can scan the documents with the emulation mode of following scanners.

Models supported by fi-5530C2

- fi-4530C
- fi-4120C
- fi-4120C2
- M3096GX
- M3093GX

Models supported by fi-5530C

- fi-4530C
- fi-5530C 03
- fi-4120C
- fi-4120C2
- fi-5120C 03
- M3096GX
- M3093GX

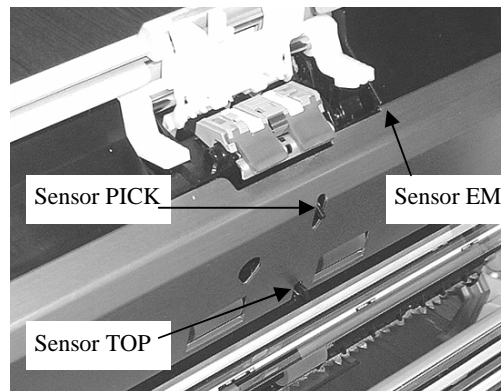

(1)How to activate Emulation mode

Open the cover. Press Sensor PICK and Function button, and then press and release Power button. Keep pressing Sensor PICK and Function button until scanner shows Screen B on the panel. The interface between PC and scanner is entirely disabled in this mode. The following display appears during the scanner initialization in the emulation switching mode activation.

Screen A

Function No. Display	Power LED	Description
8	ON	During initial processing

The console display changes as follows after initial processing.

Screen B

Function No. Display	Power LED	Description
8	ON	During test mode



Screen C

Function No. Display	Power LED	Description
8	ON	Emulation mode initial status

05	Nov. 20, 2008	K.Okada	T.Anzai	I.Fujioka	Refer to Revision Record on page 2.	TITLE	fi-5530C/fi-5530C2 IMAGE SCANNER MAINTENANCE MANUAL		
04	July 7, 2008	K.Okada	T.Anzai	I.Fujioka	Refer to Revision Record on page 2.				
03	Feb.23, 2007	K.Okada	K.Okada	T.Anzai	Refer to Revision Record on page 2.				
						DRAW. No.	P1PA03334-B30X/6		CUST.
Rev	DATE	DESIG.	CHECK	APPR.	DESCRIPTION	PFU LIMITED		PAGE	113/138
DESIG	Aug.19, 2005	K.Okada	CHECK	K.Okada	APPR. T.Anzai				

Operating Emulation mode

(1) Press **Scan** button while  is displayed on the operator panel. The screen to select the scanner model appears. The number in Function No. Display and its scanner model to be emulated are as follows.

05 <fi-5530C>

Function No. Display	Model name	Comment
0	fi-5530C	Default (Standard)
1	fi-4530C	Emulation: returns "fi-4530Cdj" as Product ID.
2	fi-4120C	Emulation: returns "fi-4120Cdj" as Product ID. When USB interface is used, scanner operates with USB 1.1 connection.
3	fi-4120C2	Emulation: returns "fi-4120C2dj" as Product ID.
4	M3096GX	Emulation: returns "M3096GX" as Product ID.
5	M3093GX	Emulation: returns "M3093GX" as Product ID.

05 <fi-5530C2>

Function No. Display	Model name	Comment
0	fi-5530C2	Default (Standard)
1	fi-4530C	Emulation: returns "fi-4530Cdj" as Product ID.
2	fi-4120C	Emulation: returns "fi-4120Cdj" as Product ID. When USB interface is used, scanner operates with USB 1.1 connection.
3	fi-4120C2	Emulation: returns "fi-4120C2dj" as Product ID.
4	M3096GX	Emulation: returns "M3096GX" as Product ID.
5	M3093GX	Emulation: returns "M3093GX" as Product ID.
6	fi-5530C	Emulation: returns "fi-5530Cdj" as Product ID.
7	fi-5120C	Emulation: returns "fi-5120Cdj" as Product ID.

(2) Press **Function** button to select the number, which indicates the scanner mode to emulate.

(3) If the selection is correct, press **Scan** button to confirm the model number. The scanner displays model numbers of selected scanner by the method described in Note A at the end of this section.

The following buttons are available while the scanner is displaying model number for emulation.

Function button: Displays Screen E11 to confirm the selection of the scanner model.

Send to button: Returns to emulation mode initial display.

Screen E11

Function No. Display	Power LED	Description
	ON	"o" (down half) blinks. Blinking cycle: 1.0S (The interval of lighting up and out is 0.5 seconds each)

<Available buttons at Screen E11>

Scan + **Function** button: Writes the scanner model of emulation in EEPROM. During writing, Screen E12 is shown. After writing scanner displays Screen E13, if the writing succeeds. Or scanner displays Screen E14, if it fails.

Send to button: Returns to the initial display of Emulation mode.

Screen E12

Function No. Display	Description
	Scanner is writing the data in EEPROM. Displays "L" blinking.

All buttons are disabled at Screen E12.

05	Nov. 20, 2008	K.Okada	T.Anzai	I.Fujioka	Refer to Revision Record on page 2.	TITLE	fi-5530C/fi-5530C2 IMAGE SCANNER MAINTENANCE MANUAL		
04	July 7, 2008	K.Okada	T.Anzai	I.Fujioka	Refer to Revision Record on page 2.	DRAW. No.	P1PA03334-B30X/6		CUST.
03	Feb.23, 2007	K.Okada	K.Okada	T.Anzai	Refer to Revision Record on page 2.				
Rev	DATE	DESIG.	CHECK	APPR.	DESCRIPTION	PFU LIMITED		PAGE	114/138
DESIG	Aug.19, 2005	K.Okada	CHECK	K.Okada	APPR. T.Anzai				

Screen E13

Function No. Display	Description
	Normal end Displays “o” (upper half) blinking.

<Available buttons at Screen E13>

Send to button: Returns to emulation mode initial display.

Screen 14

Function No. Display	Description
	Abnormal end Displays “C” blinking

<Available buttons at Screen E14>

Send to button: Returns to emulation initial display.

Note A: The display of the scanner model of emulation is as follows.

Scanner model	Display method
fi-5530C	“5530” is displayed in the following order. “.” → “5” → “5” → “3” → “0” The mark, “-“, is a start mark. Display period is 0.5 sec.
fi-4530C	“4530” is displayed in the following order. “.” → “4” → “5” → “3” → “0” The mark, “-“, is a start mark. Display period is 0.5 sec.
fi-4120C	“4120” is displayed in the following order. “.” → “4” → “1” → “2” → “0” The mark, “-“, is a start mark. Display period is 0.5 sec.
fi-4120C2	“4120” is displayed in the following order. “.” → “4” → “1” → “2” → “0” → “2” The mark, “-“, is a start mark. Display period is 0.5 sec.
M3096GX	“3096” is displayed in the following order. “.” → “3” → “0” → “9” → “6” The mark, “-“, is a start mark. Display period is 0.5 sec.
M3093DX	“3093” is displayed in the following order. “.” → “3” → “0” → “9” → “3” The mark, “-“, is a start mark. Display period is 0.5 sec.
03 fi-5120C	“5120” is displayed in the following order. “.” → “5” → “1” → “2” → “0” The mark, “-“, is a start mark. Display period is 0.5 sec.
03 fi-5530C2	“55302” is displayed in the following order. “.” → “5” → “5” → “3” → “0” → “2” The mark, “-“, is a start mark. Display period is 0.5 sec.

05	Nov. 20, 2008	K.Okada	T.Anzai	I.Fujioka	Refer to Revision Record on page 2.	TITLE	fi-5530C/fi-5530C2 IMAGE SCANNER MAINTENANCE MANUAL		
04	July 7, 2008	K.Okada	T.Anzai	I.Fujioka	Refer to Revision Record on page 2.				
03	Feb.23, 2007	K.Okada	K.Okada	T.Anzai	Refer to Revision Record on page 2.				
						DRAW. No.	P1PA03334-B30X/6		CUST.
Rev	DATE	DESIG.	CHECK	APPR.	DESCRIPTION	PFU LIMITED		PAGE	115/138
DESIG	Aug.19, 2005	K.Okada	CHECK	K.Okada	APPR. T.Anzai				

Chapter 6 Maintenance parts

POS	Description	Part number	Quantity ⁰³				Reference	Replacement procedure	Remarks	
			fi-5530C		fi-5530C2					
1	BASE UNIT	PA03334-D971	1		1		6-1	4-8		
2	DUST COVER	PA03334-D975		1		1	6-2	4-10-3		
3	HK RING SR	PA03334-F912		1		1	6-3	4-10-2	4 pieces per set	
4	INVERTER SR	PA03334-F916		1		1	6-4	4-10-4		
5	LAMP SR	PA03334-F903		1		1	6-5	4-10-5		
6	US SENSOR	PA03334-F902		1		1	6-6	4-10-1		
7	US PCA	PA03334-K906		1		1	6-7	4-10-1		
8	OPT UNIT WITH CABLE F	PA03334-D925		1		1	6-8	4-10-6		
9	CCD CABLE F	PA03334-F917		1		1	6-9	4-10-5		
10	OPTICAL UNIT	PA03334-D929		1		1	6-10	4-10-6		
11	PICK MOTOR	PA03334-D911 PA03334-D917 ⁰²		1		1	6-11	4-10-7		
12	GUIDE P ASSY	PA03334-D913		1		1	6-12	4-10-1		
13	BW MOTOR	PA03334-F919		1		1	6-13	4-10-8		
14	UPPER UNIT	PA03334-D981	1				6-14	4-8	For Europe & North America	
		PA03334-D985 ⁰³			1					
		PA03334-D987	1							For China
		PA03334-D988 ⁰³			1					
15	UPPER FRAME ASSY	PA03334-D984		1		1	6-15	4-9-8		
16	LF MOTOR	PA03334-F906 PA03334-F913 ⁰²		1		1	6-16	4-9-6		
17	US SENSOR	PA03334-F902		1		1	6-6	4-9-5		
18	SENSOR EM	PA03334-F907 PA03334-F914 ⁰²		1		1	6-17	4-9-7		
19	SENSOR PICK	PA03334-F922		1		1	6-18	4-9-7		
20	SENSOR TOP	PA03334-F923		1		1	6-19	4-9-7		
21	INVERTER SR	PA03334-F916		1		1	6-4	4-9-2		
22	LAMP SR	PA03334-F903		1		1	6-5	4-9-4		
23	OPT UNIT WITH CABLE B	PA03334-D927		1		1	6-20	4-9-3		
24	CCD CABLE B	PA03334-F918		1		1	6-21	4-9-3		
25	OPTICAL UNIT	PA03334-D929		1		1	6-10	4-9-3		
26	PANEL PCA	PA03334-K907	1			1	6-22	4-9-1		
27	CONTROL PCA	PA03334-K905	1				6-23	4-11		
		PA03334-K915 ⁰³			1					
28	STACKER UNIT	PA03334-D944	1			1	6-24	4-7-2		
29	CHUTE UNIT	PA03334-D943	1			1	6-25	4-7-1		
30	AC ADAPTER	PA03334-K910	1				6-26			
		PA03334-K920 ⁰³			1					
31	AC CORDSET U	PA63802-1831 PA63082-1831 ⁰²					6-27		For North America	
32	AC CORDSET E	PA63803-1831 PA63083-1831 ⁰²	1			1			For Europe	
34	AC CORDSET C	PA63804-1831 PA63084-1831 ⁰²					6-28		For China	
⁰² 33	AC CORDSET UK	PA63098-1831							For Europe	

⁰²

05	Nov. 20, 2008	K.Okada	T.Anzai	I.Fujioka	Refer to Revision Record on page 2.	TITLE	fi-5530C/fi-5530C2 IMAGE SCANNER MAINTENANCE MANUAL		
04	July 7, 2008	K.Okada	T.Anzai	I.Fujioka	Refer to Revision Record on page 2.				
03	Feb.23, 2007	K.Okada	K.Okada	T.Anzai	Refer to Revision Record on page 2.				
						DRAW. No.	P1PA03334-B30X/6		CUST.
Rev	DATE	DESIG.	CHECK	APPR.	DESCRIPTION	PFU LIMITED		PAGE	116/138
DESIG	Aug.19, 2005	K.Okada	CHECK	K.Okada	APPR. T.Anzai				

6-1. Base Unit

Description	Parts No.	Remarks	Figure
Base Unit	PA03334-D971		6-1

NOTICE

This unit includes a lamp that contains mercury. Dispose of the scanner should be conducted as required by local ordinances or regulations.

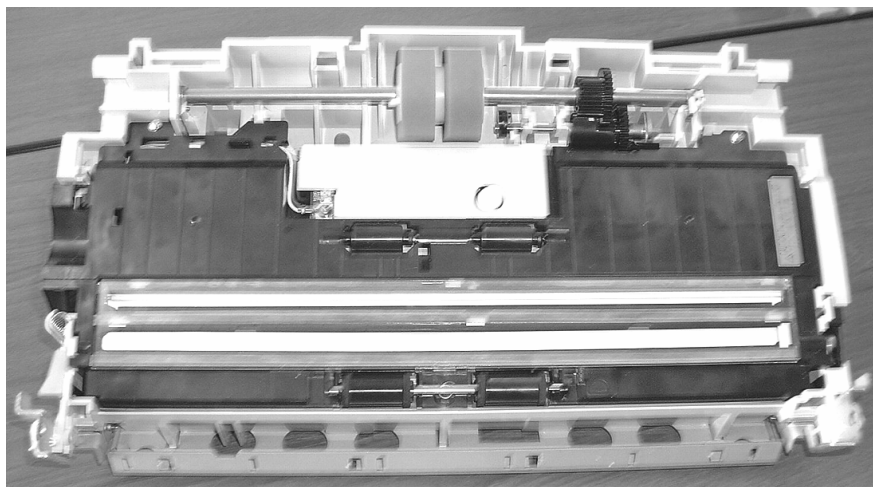

Figure 6-1

6-2. Dust Cover

Description	Parts No.	Remarks	Figures
Dust Cover	PA03334-D975		6-2

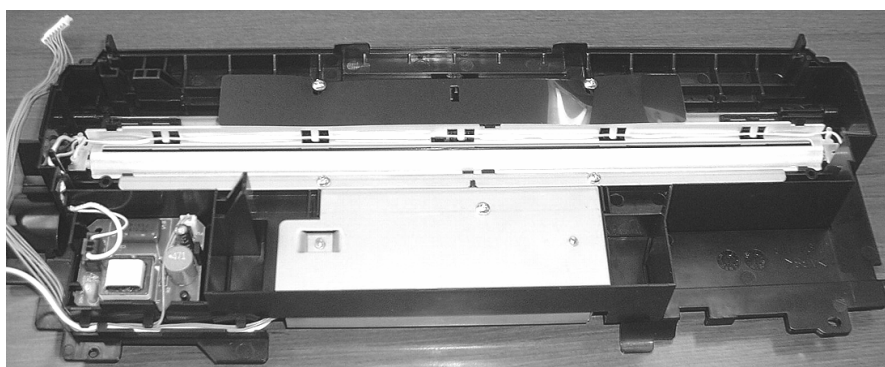
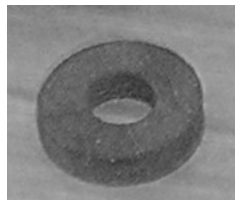

Figure 6-2

05	Nov. 20, 2008	K.Okada	T.Anzai	I.Fujioka	Refer to Revision Record on page 2.	TITLE fi-5530C/fi-5530C2 IMAGE SCANNER MAINTENANCE MANUAL	DRAW. No. P1PA03334-B30X/6	CUST.
04	July 7, 2008	K.Okada	T.Anzai	I.Fujioka	Refer to Revision Record on page 2.			
03	Feb.23, 2007	K.Okada	K.Okada	T.Anzai	Refer to Revision Record on page 2.			
Rev	DATE	DESIG.	CHECK	APPR.	DESCRIPTION	PFU LIMITED	PAGE	117/138
DESIG	Aug.19, 2005	K.Okada	CHECK	K.Okada	APPR. T.Anzai			

6-3. HK Ring SR

Description	Parts No.	Remarks	Figures
HK Ring SR	PA03334-F912	4 pieces/set	6-3



4 pieces

Figure 6-3

6-4. Inverter SR

Description	Parts No.	Remarks	Figure
Inverter SR	PA03334-F916		6-4

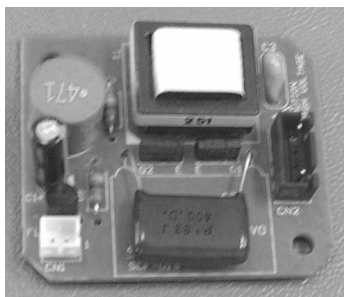

Figure 6-4

05	Nov. 20, 2008	K.Okada	T.Anzai	I.Fujioka	Refer to Revision Record on page 2.	TITLE fi-5530C/fi-5530C2 IMAGE SCANNER MAINTENANCE MANUAL	DRAW. No. P1PA03334-B30X/6	CUST.
04	July 7, 2008	K.Okada	T.Anzai	I.Fujioka	Refer to Revision Record on page 2.			
03	Feb.23, 2007	K.Okada	K.Okada	T.Anzai	Refer to Revision Record on page 2.			
Rev	DATE	DESIG.	CHECK	APPR.	DESCRIPTION	PFU LIMITED	PAGE	118/138
DESIG	Aug.19, 2005	K.Okada	CHECK	K.Okada	APPR. T.Anzai			

6-5. Lamp SR

Description	Parts No.	Remarks	Figures
Lamp SR	PA03334-F903		6-5

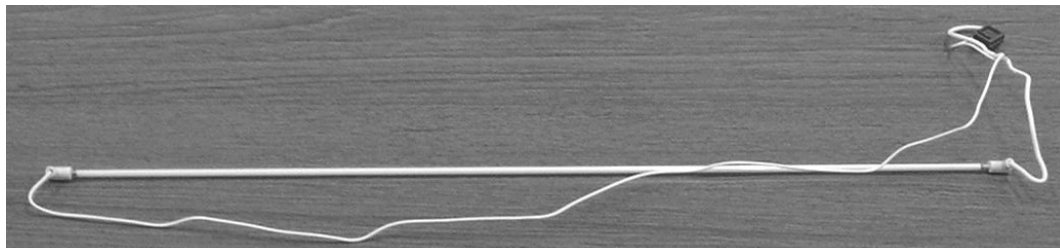

Figure 6-5

NOTICE

Lamp includes mercury.
 Dispose of the scanner should be conducted as required by local ordinances or regulations.

6-6. US Sensor

Description	Parts No.	Remarks	Figure
US Sensor	PA03334-F902		6-13

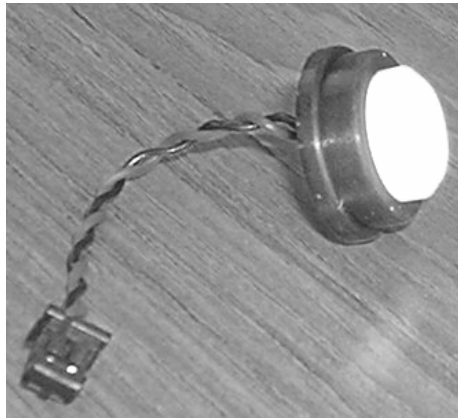

Figure 6-6

05	Nov. 20, 2008	K.Okada	T.Anzai	I.Fujioka	Refer to Revision Record on page 2.	TITLE fi-5530C/fi-5530C2 IMAGE SCANNER MAINTENANCE MANUAL	DRAW. No. P1PA03334-B30X/6	CUST.
04	July 7, 2008	K.Okada	T.Anzai	I.Fujioka	Refer to Revision Record on page 2.			
03	Feb.23, 2007	K.Okada	K.Okada	T.Anzai	Refer to Revision Record on page 2.			
Rev	DATE	DESIG.	CHECK	APPR.	DESCRIPTION	PFU LIMITED	PAGE	119/138
DESIG	Aug.19, 2005	K.Okada	CHECK	K.Okada	APPR. T.Anzai			

6-7. US PCA

Description	Parts No.	Remarks	Figures
US PCA	PA03334-K906		6-7

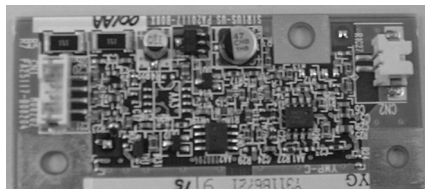

Figure 6-7

6-8. Optical Unit With Cable F

Description	Parts No.	Remarks	Figure
Optical Unit With Cable F	PA03334-D925		6-8

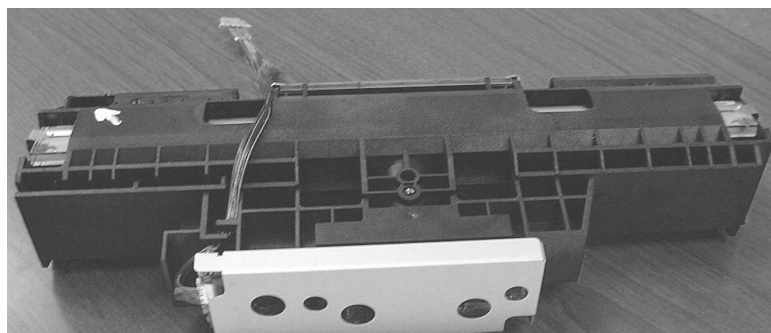

Figure 6-8

05	Nov. 20, 2008	K.Okada	T.Anzai	I.Fujioka	Refer to Revision Record on page 2.	TITLE fi-5530C/fi-5530C2 IMAGE SCANNER MAINTENANCE MANUAL	DRAW. No. P1PA03334-B30X/6	CUST.
04	July 7, 2008	K.Okada	T.Anzai	I.Fujioka	Refer to Revision Record on page 2.			
03	Feb.23, 2007	K.Okada	K.Okada	T.Anzai	Refer to Revision Record on page 2.			
Rev	DATE	DESIG.	CHECK	APPR.	DESCRIPTION	PFU LIMITED	PAGE	120/138
DESIG	Aug.19, 2005	K.Okada	CHECK	K.Okada	APPR. T.Anzai			

6-9. CCD Cable F

Description	Parts No.	Remarks	Figures
CCD Cable F	PA03334-F917	Shorter than CCD Cable B	6-9

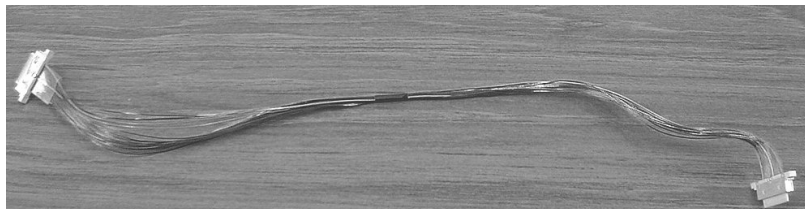

Figure 6-9

6-10. Optical Unit

Description	Parts No.	Remarks	Figure
Optical Unit	PA03334-D929		6-10

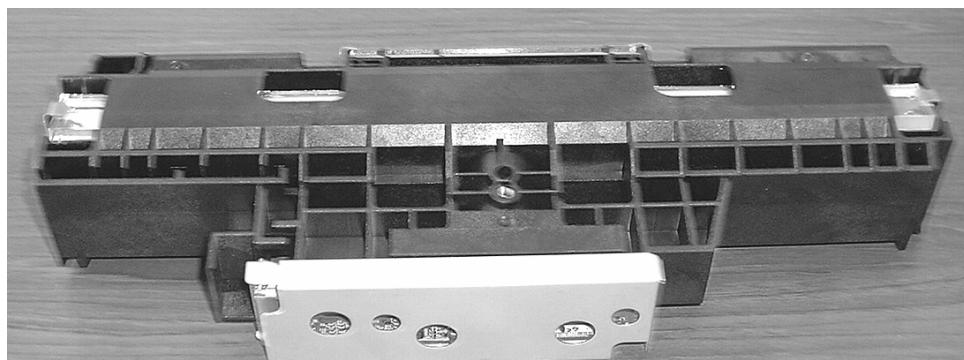

Figure 6-10

05	Nov. 20, 2008	K.Okada	T.Anzai	I.Fujioka	Refer to Revision Record on page 2.	TITLE fi-5530C/fi-5530C2 IMAGE SCANNER MAINTENANCE MANUAL	DRAW. No. P1PA03334-B30X/6	CUST.
04	July 7, 2008	K.Okada	T.Anzai	I.Fujioka	Refer to Revision Record on page 2.			
03	Feb.23, 2007	K.Okada	K.Okada	T.Anzai	Refer to Revision Record on page 2.			
Rev	DATE	DESIG.	CHECK	APPR.	DESCRIPTION	PFU LIMITED	PAGE	121/138
DESIG	Aug.19, 2005	K.Okada	CHECK	K.Okada	APPR. T.Anzai			

6-11. Pick Motor

Description	Parts No.	Remarks	Figure
Pick Motor	PA03334-D911 PA03334-D917 02		6-11

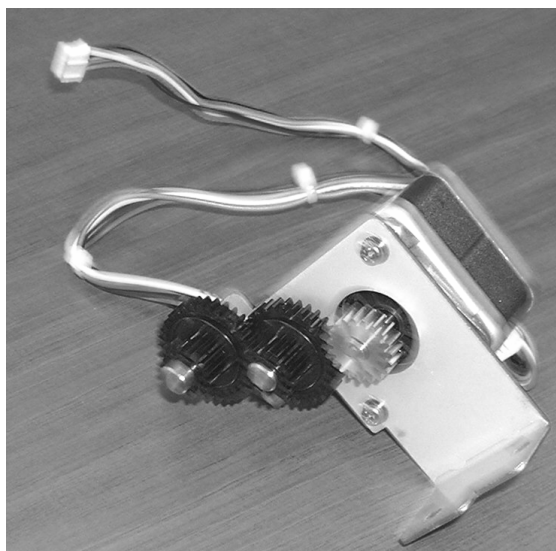

Figure 6-11

6-12. Guide P ASSY

Description	Parts No.	Remarks	Figure
Guide P ASSY	PA03334-D913		6-12

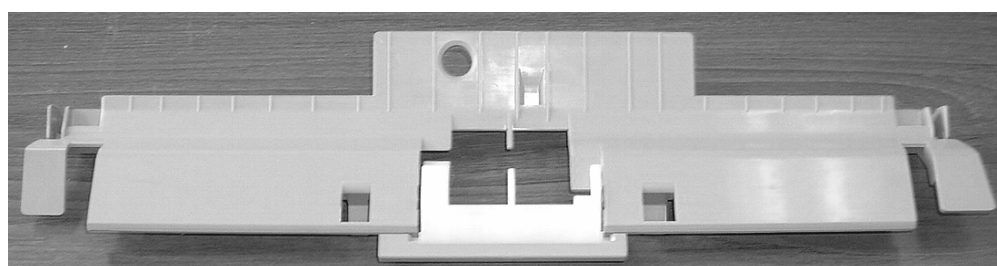

Figure 6-12

05	Nov. 20, 2008	K.Okada	T.Anzai	I.Fujioka	Refer to Revision Record on page 2.	TITLE fi-5530C/fi-5530C2 IMAGE SCANNER MAINTENANCE MANUAL	DRAW. No. P1PA03334-B30X/6	CUST.
04	July 7, 2008	K.Okada	T.Anzai	I.Fujioka	Refer to Revision Record on page 2.			
03	Feb.23, 2007	K.Okada	K.Okada	T.Anzai	Refer to Revision Record on page 2.			
Rev	DATE	DESIG.	CHECK	APPR.	DESCRIPTION	PFU LIMITED	PAGE	122/138
DESIG	Aug.19, 2005	K.Okada	CHECK	K.Okada	APPR. T.Anzai			

6-13. BW Motor

Description	Parts No.	Remarks	Figures
BW Motor	PA03334-F919		6-13

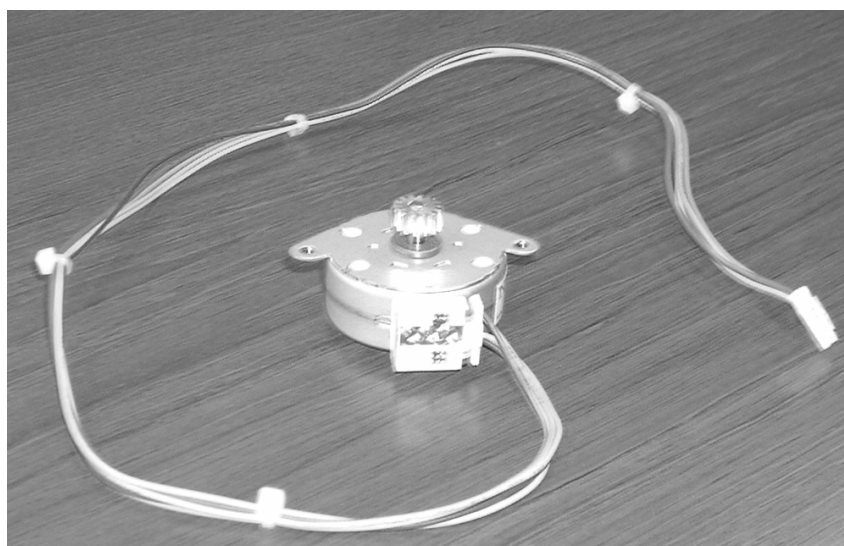

Figure 6-13

6-14. Upper Unit

Description	Parts No.	03	Remarks	Figure
Upper Unit	PA03334-D981 (fi-5530C)		For Europe and North America	Note: Panel PCA is excluded.
	PA03334-D985 (fi-5530C2)			
	PA03334-D987 (fi-5530C)		For China	
	PA03334-D988 (fi-5530C2)			

NOTICE

This unit includes a lamp that contains mercury. Dispose of the scanner should be conducted as required by local ordinances or regulations.

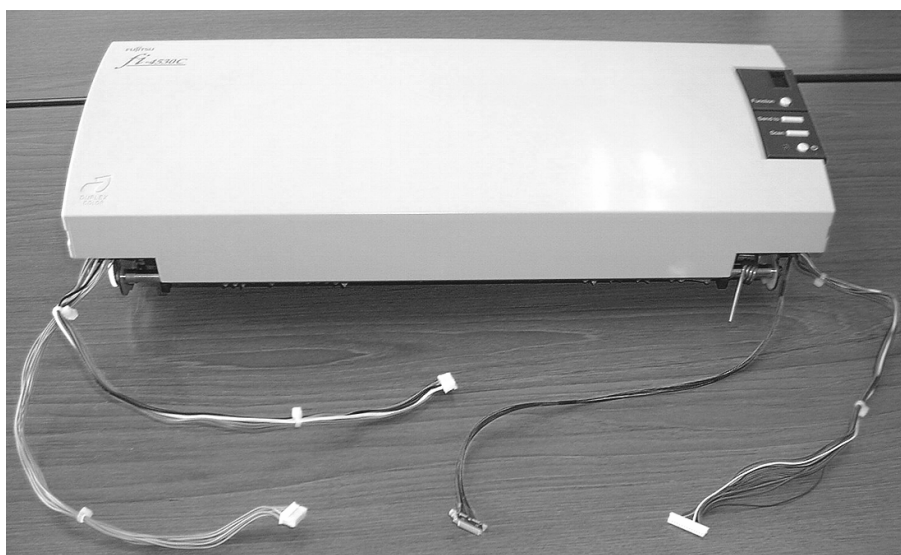

Figure 6-14

05	Nov. 20, 2008	K.Okada	T.Anzai	I.Fujioka	Refer to Revision Record on page 2.	TITLE fi-5530C/fi-5530C2 IMAGE SCANNER MAINTENANCE MANUAL	DRAW. No. P1PA03334-B30X/6	CUST.
04	July 7, 2008	K.Okada	T.Anzai	I.Fujioka	Refer to Revision Record on page 2.			
03	Feb.23, 2007	K.Okada	K.Okada	T.Anzai	Refer to Revision Record on page 2.			
Rev	DATE	DESIG.	CHECK	APPR.	DESCRIPTION	PFU LIMITED	PAGE	123/138
DESIG	Aug.19, 2005	K.Okada	CHECK	K.Okada	APPR. T.Anzai			

6-15. Upper Frame ASSY

Description	Parts No.	Remarks	Figure
Upper Frame ASSY	PA03334-D984		6-15

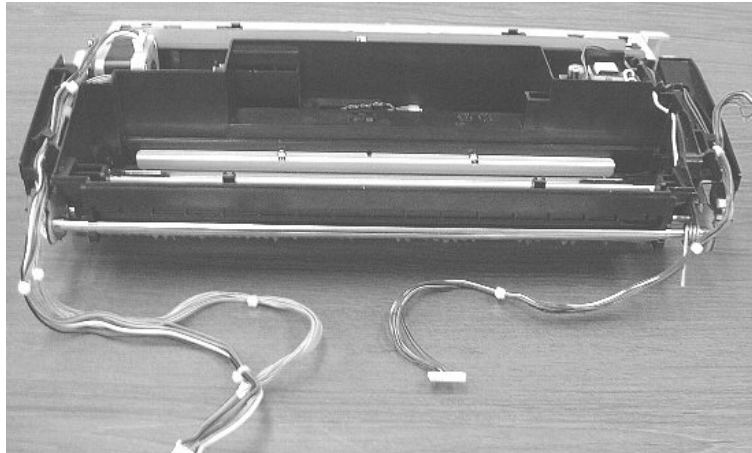

Figure 6-15

6-16. LF Motor

Description	Parts No.	Remarks	Figures
LF Motor	PA03334-F906 PA03334-F913 02		6-16

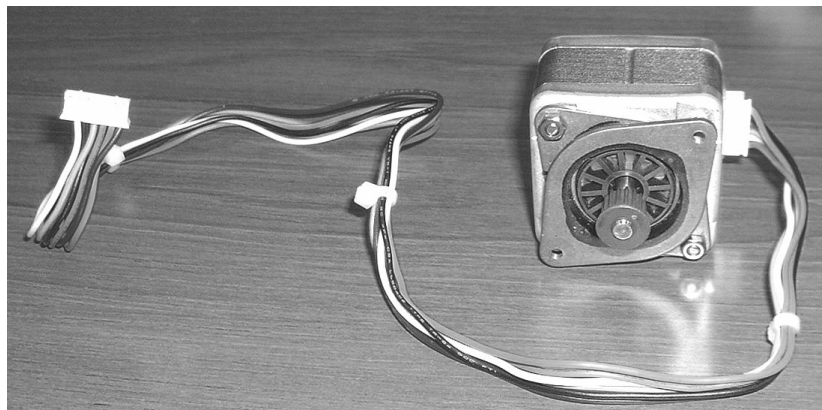

Figure 6-16

05	Nov. 20, 2008	K.Okada	T.Anzai	I.Fujioka	Refer to Revision Record on page 2.	TITLE fi-5530C/fi-5530C2 IMAGE SCANNER MAINTENANCE MANUAL	DRAW. No. P1PA03334-B30X/6	CUST.
04	July 7, 2008	K.Okada	T.Anzai	I.Fujioka	Refer to Revision Record on page 2.			
03	Feb.23, 2007	K.Okada	K.Okada	T.Anzai	Refer to Revision Record on page 2.			
Rev	DATE	DESIG.	CHECK	APPR.	DESCRIPTION	PFU LIMITED	PAGE	124/138
DESIG	Aug.19, 2005	K.Okada	CHECK	K.Okada	APPR. T.Anzai			

6-17. Sensor EM

Description	Parts No.	Remarks	Figures
Sensor EM	PA03334-F907 PA03334-F914 02		6-17

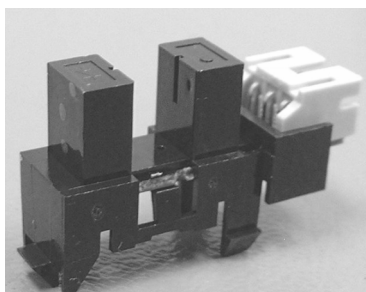

Figure 6-17

6-18. Sensor PICK

Description	Parts No.	Remarks	Figures
Sensor PICK	PA03334-F922		6-18

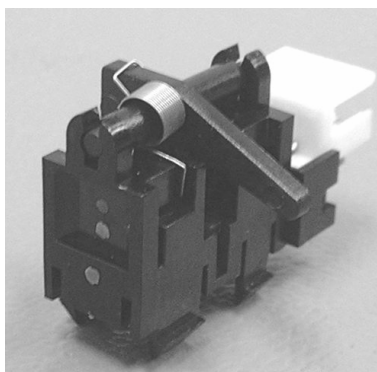

Figure 6-18

05	Nov. 20, 2008	K.Okada	T.Anzai	I.Fujioka	Refer to Revision Record on page 2.	TITLE fi-5530C/fi-5530C2 IMAGE SCANNER MAINTENANCE MANUAL	DRAW. No. P1PA03334-B30X/6	CUST.
04	July 7, 2008	K.Okada	T.Anzai	I.Fujioka	Refer to Revision Record on page 2.			
03	Feb.23, 2007	K.Okada	K.Okada	T.Anzai	Refer to Revision Record on page 2.			
Rev	DATE	DESIG.	CHECK	APPR.	DESCRIPTION	PFU LIMITED		PAGE 125/138
DESIG	Aug.19, 2005	K.Okada	CHECK	K.Okada	APPR. T.Anzai			

6-19. Sensor TOP

Description	Parts No.	Remarks	Figures
Sensor TOP	PA03334-F923		6-19

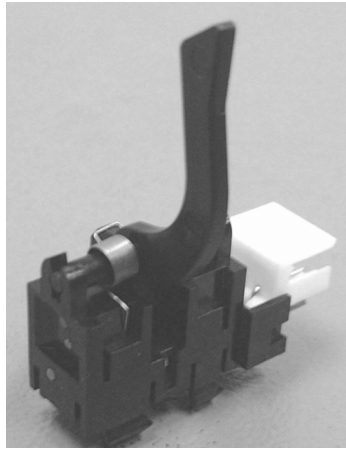

Figure 6-19

6-20. Optical Unit With Cable B

Description	Parts No.	Remarks	Figure
Optical Unit With Cable B	PA03334-D927		6-20

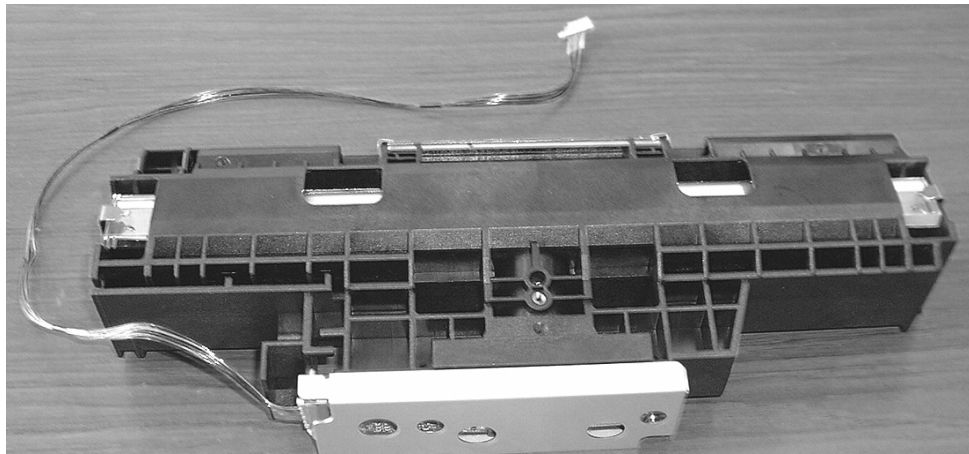

Figure 6-20

05	Nov. 20, 2008	K.Okada	T.Anzai	I.Fujioka	Refer to Revision Record on page 2.	TITLE fi-5530C/fi-5530C2 IMAGE SCANNER MAINTENANCE MANUAL	DRAW. No. P1PA03334-B30X/6	CUST.
04	July 7, 2008	K.Okada	T.Anzai	I.Fujioka	Refer to Revision Record on page 2.			
03	Feb.23, 2007	K.Okada	K.Okada	T.Anzai	Refer to Revision Record on page 2.			
Rev	DATE	DESIG.	CHECK	APPR.	DESCRIPTION	PFU LIMITED		PAGE 126/138
DESIG	Aug.19, 2005	K.Okada	CHECK	K.Okada	APPR. T.Anzai			

6-21. CCD Cable B

Description	Parts No.	Remarks	Figures
CCD Cable B	PA03334-F918	Longer than CCS cable F	6-21

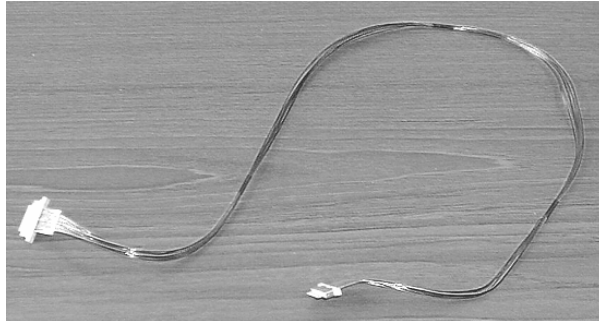

Figure 6-21

6-22. Panel PCA

Description	Parts No.	Remarks	Figures
Panel PCA	PA03334-K907		6-22

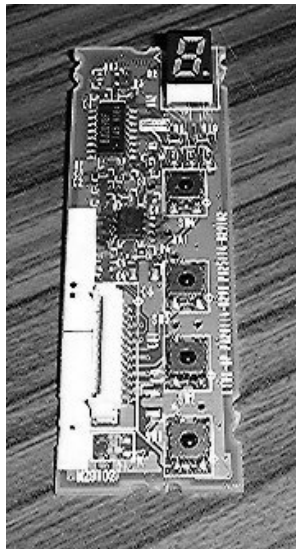

Figure 6-22

05	Nov. 20, 2008	K.Okada	T.Anzai	I.Fujioka	Refer to Revision Record on page 2.	TITLE fi-5530C/fi-5530C2 IMAGE SCANNER MAINTENANCE MANUAL	DRAW. No. P1PA03334-B30X/6	CUST.
04	July 7, 2008	K.Okada	T.Anzai	I.Fujioka	Refer to Revision Record on page 2.			
03	Feb.23, 2007	K.Okada	K.Okada	T.Anzai	Refer to Revision Record on page 2.			
Rev	DATE	DESIG.	CHECK	APPR.	DESCRIPTION	PFU LIMITED	PAGE	127/138
DESIG	Aug.19, 2005	K.Okada	CHECK	K.Okada	APPR. T.Anzai			

6-23. Control PCA

Description	Parts No.	03	Remarks	Figures
Control PCA	PA03334-K905 (fi-5530C) PA03334-K915 (fi-5530C2)			6-23

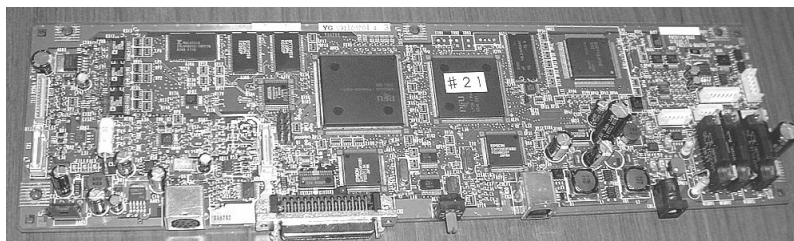

Figure 6-23

6-24. Stacker Unit

Description	Parts No.	Remarks	Figure
Stacker Unit	PA03334-D944		6-24



Figure 6-24

05	Nov. 20, 2008	K.Okada	T.Anzai	I.Fujioka	Refer to Revision Record on page 2.	TITLE fi-5530C/fi-5530C2 IMAGE SCANNER MAINTENANCE MANUAL	DRAW. No. P1PA03334-B30X/6	CUST.
04	July 7, 2008	K.Okada	T.Anzai	I.Fujioka	Refer to Revision Record on page 2.			
03	Feb.23, 2007	K.Okada	K.Okada	T.Anzai	Refer to Revision Record on page 2.			
Rev	DATE	DESIG.	CHECK	APPR.	DESCRIPTION	PFU LIMITED	PAGE	128/138
DESIG	Aug.19, 2005	K.Okada	CHECK	K.Okada	APPR. T.Anzai			

6-25. Chute Unit

Description	Parts No.	Remarks	Figures
Chute Unit	PA03334-D943		6-25

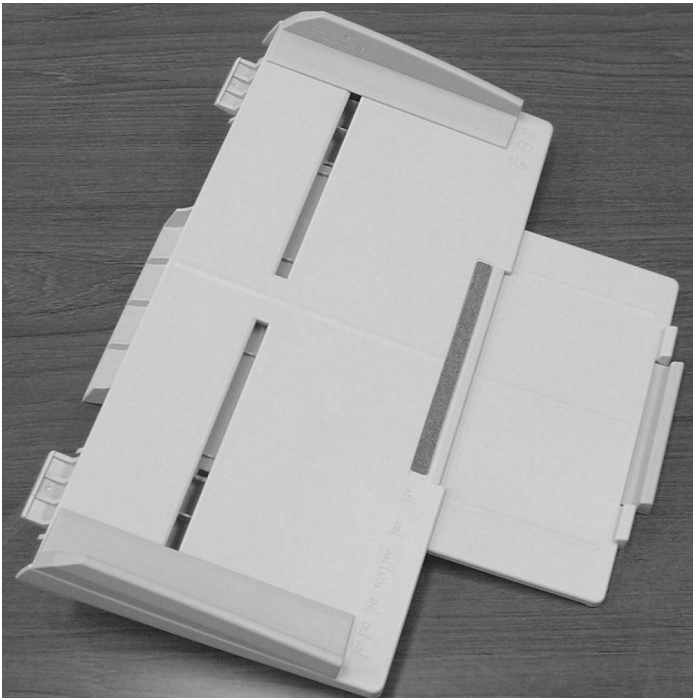

Figure 6-25

6-26. AC Adapter

Description	Parts No.	Remarks	Figures
AC Adapter	PA03334-K910 (fi-5530C) PA03334-K920 (fi-5530C2)		6-26



Figure 6-26

05	Nov. 20, 2008	K.Okada	T.Anzai	I.Fujioka	Refer to Revision Record on page 2.	TITLE fi-5530C/fi-5530C2 IMAGE SCANNER MAINTENANCE MANUAL	DRAW. No. P1PA03334-B30X/6	PAGE 129/138
04	July 7, 2008	K.Okada	T.Anzai	I.Fujioka	Refer to Revision Record on page 2.			
03	Feb.23, 2007	K.Okada	K.Okada	T.Anzai	Refer to Revision Record on page 2.			
Rev	DATE	DESIG.	CHECK	APPR.	DESCRIPTION	PFU LIMITED		PAGE
DESIG	Aug.19, 2005	K.Okada	CHECK	K.Okada	APPR. T.Anzai			

6-27. AC Cordset U

Description	Parts No.	Remarks	Figures
AC Cordset U	PA63082-1831	For North America	6-27

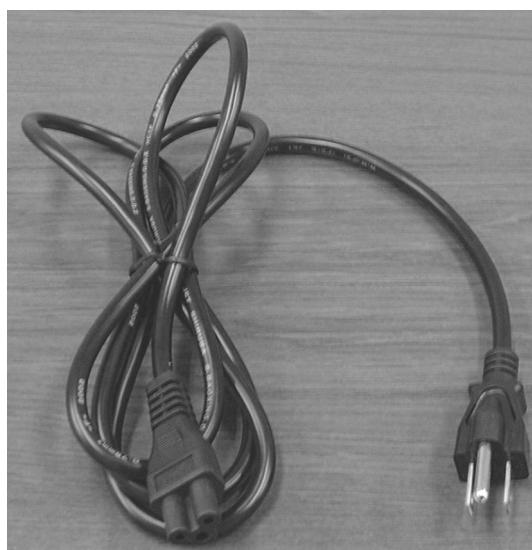

Figure 6-27

02

6-28. AC Cordset E / AC Cordset C / AC Cordset UK

Description	Parts No.	Remarks	Figure
AC Cordset E	PA63083-1831	For Europe	6-28
AC Cordset C	PA63084-1831	For China	
AC Cordset UK	PA63098-1831	For Europe	

02

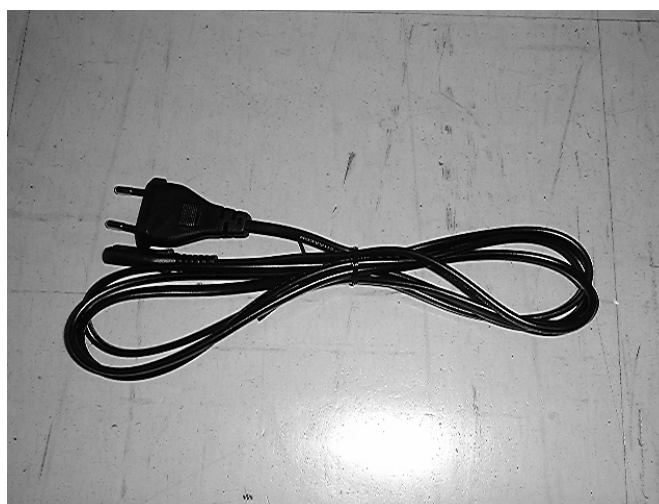

Figure 6-28

05	Nov. 20, 2008	K.Okada	T.Anzai	I.Fujioka	Refer to Revision Record on page 2.	TITLE fi-5530C/fi-5530C2 IMAGE SCANNER MAINTENANCE MANUAL	DRAW. No. P1PA03334-B30X/6	CUST.
04	July 7, 2008	K.Okada	T.Anzai	I.Fujioka	Refer to Revision Record on page 2.			
03	Feb.23, 2007	K.Okada	K.Okada	T.Anzai	Refer to Revision Record on page 2.			
Rev	DATE	DESIG.	CHECK	APPR.	DESCRIPTION	PFU LIMITED	PAGE	130/138
DESIG	Aug.19, 2005	K.Okada	CHECK	K.Okada	APPR. T.Anzai			

Appendix A Definition of Scanner and Camera Properties

The following describes scanner driver setting that is excerpted from TWAIN driver (ST1 version) manual and modified for fi-5530C/fi-5530C2. 03

A.1 Displaying Scanner and Camera Properties

Double-click the [Scanner and Camera] icon on the [Control Panel] to display the corresponding Properties dialog box.

If the scanner driver has been properly installed, the icon of your scanner is displayed. Select the model name. And double-click the icon or select [Properties...] by using right-click. The Properties dialog box shown below is displayed.

In this dialog box, events can be set, the scanner can be checked, and information related to different kinds of related devices can be confirmed and set. An explanation of each tab folder and its use is below.

A.2 General Tab

General information on the driver for a connected scanner can be displayed, and the connection can be tested from this folder.

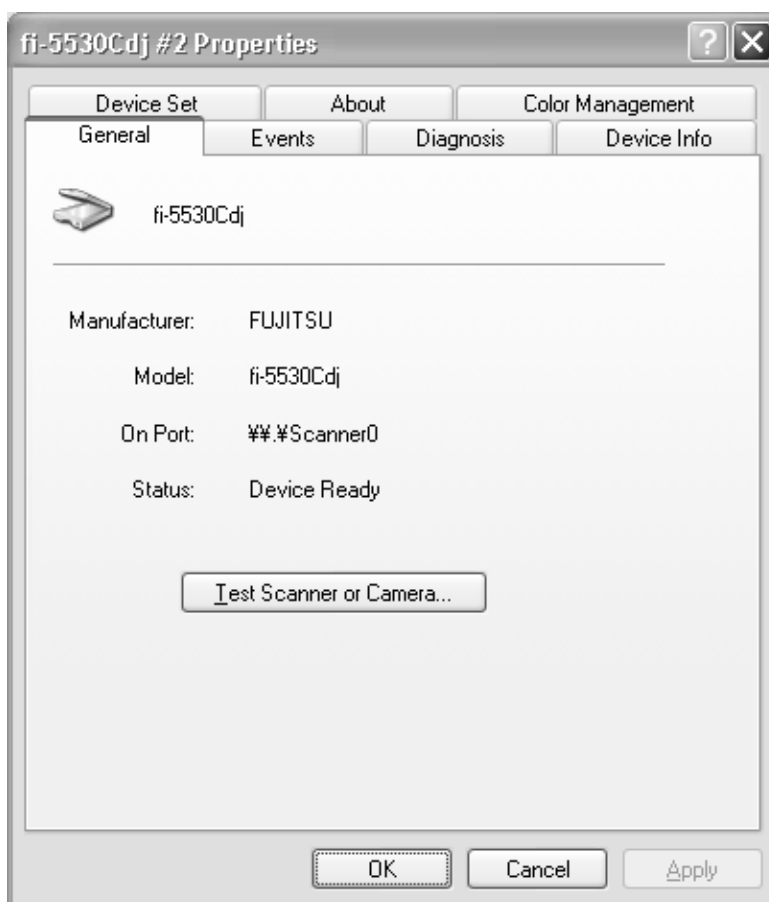

05	Nov. 20, 2008	K.Okada	T.Anzai	I.Fujioka	Refer to Revision Record on page 2.	TITLE	fi-5530C/fi-5530C2 IMAGE SCANNER MAINTENANCE MANUAL		
04	July 7, 2008	K.Okada	T.Anzai	I.Fujioka	Refer to Revision Record on page 2.				
03	Feb.23, 2007	K.Okada	K.Okada	T.Anzai	Refer to Revision Record on page 2.				
						DRAW. No.	P1PA03334-B30X/6		CUST.
Rev	DATE	DESIG.	CHECK	APPR.	DESCRIPTION	PFU LIMITED		PAGE	131/138
DESIG	Aug.19, 2005	K.Okada	CHECK	K.Okada	APPR. T.Anzai				

A.3 Events Tab

On the Events tab, an application can be specified to be started automatically by “Scanner events” such as “pushing buttons on the scanner”.

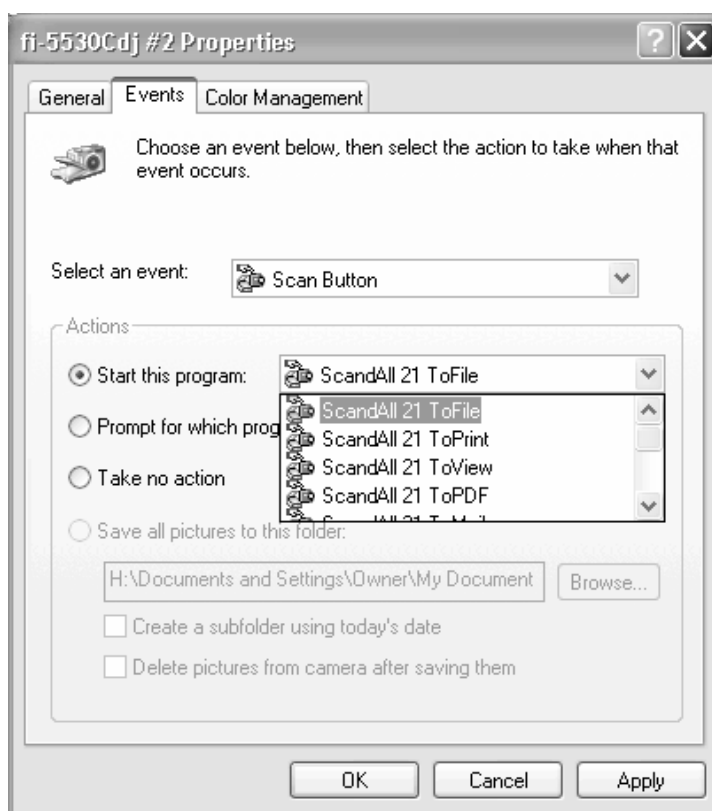

(The screen above is for Windows XP)

◆ **Select an event** (“Scanner event” in case of OS other than Windows XP)

Select a “Scanner event” from the list box to start an application. Select the item to set up from the following events.

“Scan button”: When pushing the “Scan” button of the scanner.

“Send to1-9”: When pushing the “SendTo” button of the scanner.

◆ **Actions** (displayed in case of Windows XP)

Select an action when the event selected [Select an event] occurs.

- **Start this program:** The application selected from the right list box starts when the event occurs.
- **Prompt for which program to run:** The window for selecting application appears when the event occurs.
- **Take no action:** Nothing starts even if the event occurs.

05	Nov. 20, 2008	K.Okada	T.Anzai	I.Fujioka	Refer to Revision Record on page 2.	TITLE	fi-5530C/fi-5530C2 IMAGE SCANNER MAINTENANCE MANUAL		
04	July 7, 2008	K.Okada	T.Anzai	I.Fujioka	Refer to Revision Record on page 2.				
03	Feb.23, 2007	K.Okada	K.Okada	T.Anzai	Refer to Revision Record on page 2.				
						DRAW. No.	P1PA03334-B30X/6		CUST.
Rev	DATE	DESIG.	CHECK	APPR.	DESCRIPTION	PFU LIMITED		PAGE	132/138
DESIG	Aug.19, 2005	K.Okada	CHECK	K.Okada	APPR. T.Anzai				

◆ **Send to this application** (displayed in case of OS other than Windows XP)

Mark on the check box of an application to be started by the operation specified in the above Scanner events. Multiple applications can be specified. When two or more applications are specified, a dialog box appears to select one to be started is by the operation.

◆ **Disable device events** (displayed in case of OS other than Windows XP)

If these functions are not used, mark on this check box.

* If the above settings are not activated by clicking [OK] or [Apply], reboot the PC.

A.4 Diagnostic Tab

To perform more detailed diagnostic tests than those provided in the general tab folder, click the [Diagnose] button.

In Windows 2000 or Windows XP, only a user who has administrator authority can run these tests.

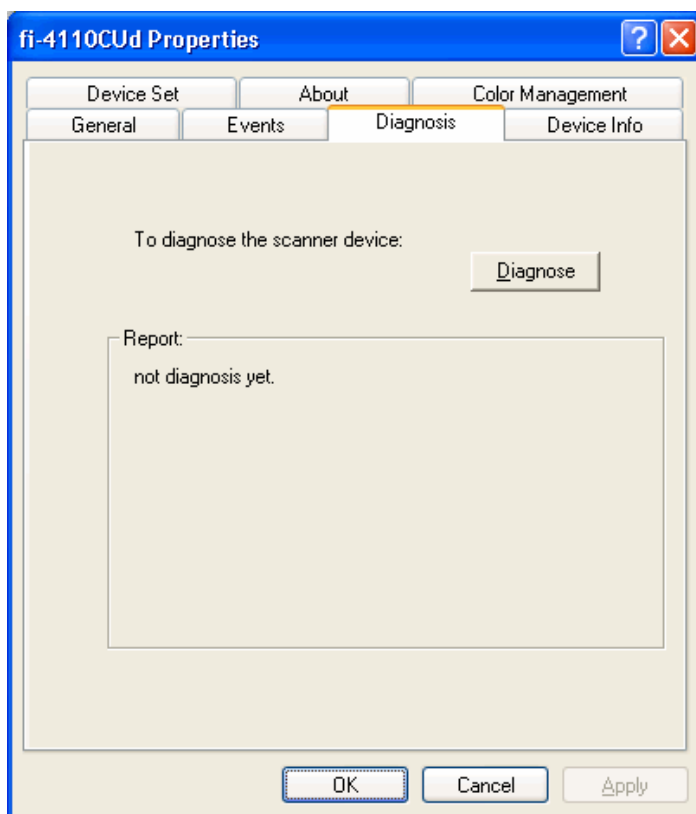

<The message after diagnosis>

“Hardware error not detected”
This means the diagnosis ends normally:

“General error detected. Diagnosis aborted”
This means the diagnosis ends abnormally:
Check the followings and try diagnosis again.

- 1) Is the scanner ON?
- 2) Is the scanner connected to the host PC?
- 3) Does the Function No. Display show an error? Go to Section 3.1 and follow the countermeasures corresponding to the error.

(The example screen is for fi-4110CU)

05	Nov. 20, 2008	K.Okada	T.Anzai	I.Fujioka	Refer to Revision Record on page 2.	TITLE	fi-5530C/fi-5530C2 IMAGE SCANNER MAINTENANCE MANUAL		
04	July 7, 2008	K.Okada	T.Anzai	I.Fujioka	Refer to Revision Record on page 2.				
03	Feb.23, 2007	K.Okada	K.Okada	T.Anzai	Refer to Revision Record on page 2.				
						DRAW. No.	P1PA03334-B30X/6	CUST.	
Rev	DATE	DESIG.	CHECK	APPR.	DESCRIPTION	PFU LIMITED		PAGE	133/138
DESIG	Aug.19, 2005	K.Okada	CHECK	K.Okada	APPR. T.Anzai				

A.5 Device Information Tab

A list of the functions compatible with the selected scanner driver is displayed. The items displayed depend on the selected model of scanner. Only hardware functions are displayed. The functions realized by software are not displayed in this tab folder. Therefore, the displayed content may not match the content specified during reading. The contents of this tab folder are not displayed if the scanner driver is either currently in use or not connected to the computer. If they are not displayed, stop the application being used by the scanner driver or check the connection. Then, select this tab folder again to display the contents.

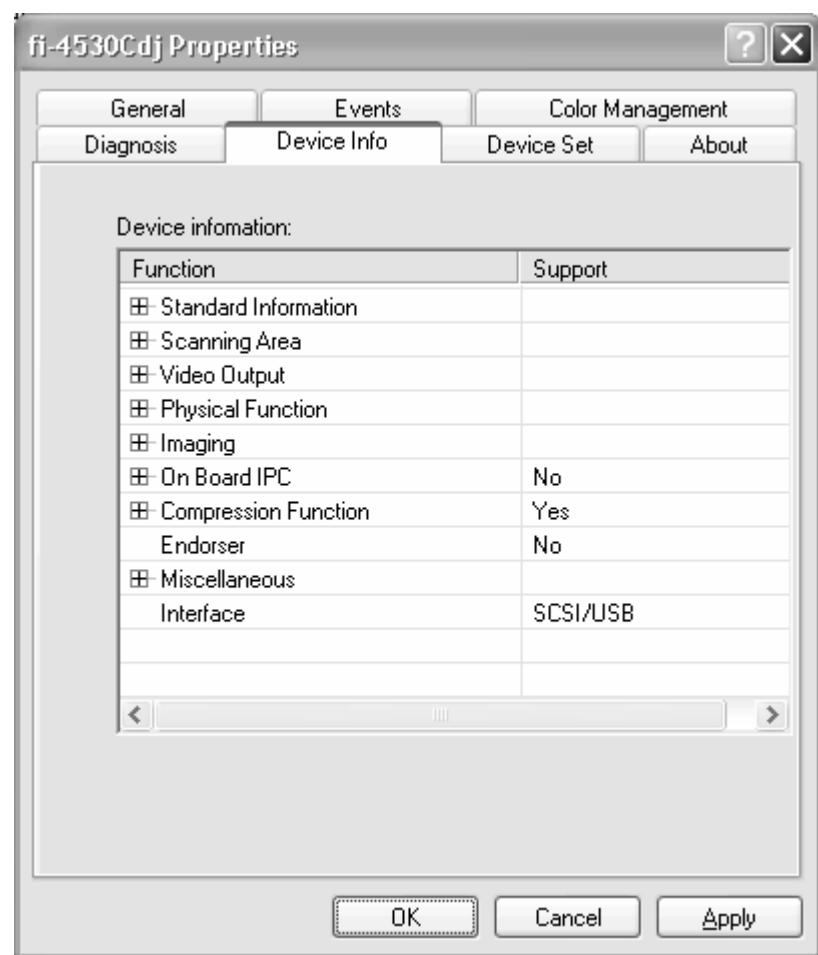

(The example screen is for fi-4530C)

05	Nov. 20, 2008	K.Okada	T.Anzai	I.Fujioka	Refer to Revision Record on page 2.	TITLE	fi-5530C/fi-5530C2 IMAGE SCANNER MAINTENANCE MANUAL		
04	July 7, 2008	K.Okada	T.Anzai	I.Fujioka	Refer to Revision Record on page 2.				
03	Feb.23, 2007	K.Okada	K.Okada	T.Anzai	Refer to Revision Record on page 2.				
						DRAW. No.	P1PA03334-B30X/6		CUST.
Rev	DATE	DESIG.	CHECK	APPR.	DESCRIPTION	PFU LIMITED		PAGE	134/138
DESIG	Aug.19, 2005	K.Okada	CHECK	K.Okada	APPR. T.Anzai				

A.6 Device Setup Tab

Information related to the operation and maintenance of the scanner driver can be displayed and set up. For some scanner models, some items cannot be set up (grayed out). Changing the setup activates the [Apply] button. The changed setup is reflected on the device only if the [Apply] button or [OK] button is clicked. The contents of this tab folder are not displayed if the scanner driver is either currently in use or not connected to the computer. If they are not displayed, stop the application being used by the scanner driver or check the connection. Then, select this tab folder again to display the data.

In Windows 2000 or Windows XP, only a user who has administrator authority can change the setup from this tab folder.

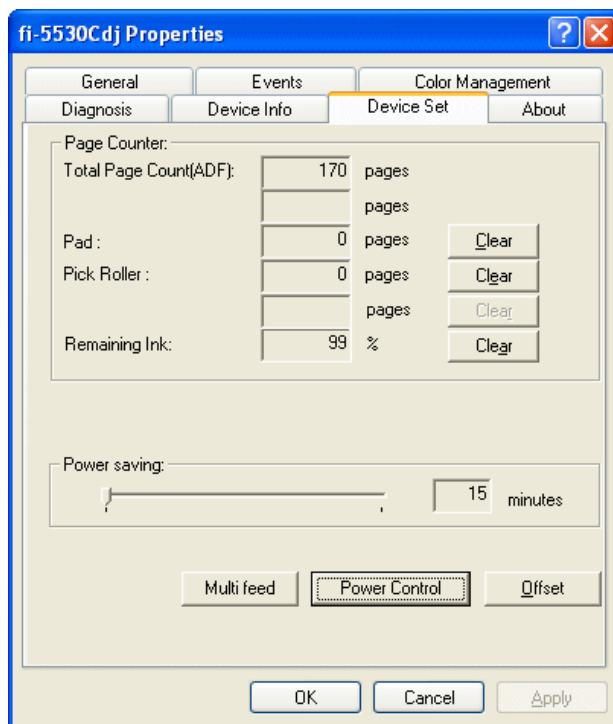

◆ Page Counter

An approximate total numbers of pages ever read. An equivalent count of the pages scanned after consumables are replaced and remaining ink amount are also displayed.

To set the consumables counter to zero after replacing consumables, click the [Clear] button. This operation can be executed using the operation panel of the device.

03

<Counters supported by fi-5530C/fi-5530C2>

Total number of sheets ever scanned (ADF): Incremented after scanning 10 sheets

Pad counter : Incremented after scanning 500 sheets

Pick counter: Incremented after scanning 500 sheets

Remaining Ink: Shown in percentage.

Note:

Depending on some scanner models, once the [Device Set] tab appears, the operation panel is unable to be handled. In this case, close this dialog and turn the power ON/OFF of the scanner. After the scanner setup, the operation panel is able to be handled.

05	Nov. 20, 2008	K.Okada	T.Anzai	I.Fujioka	Refer to Revision Record on page 2.	TITLE	fi-5530C/fi-5530C2 IMAGE SCANNER MAINTENANCE MANUAL		
04	July 7, 2008	K.Okada	T.Anzai	I.Fujioka	Refer to Revision Record on page 2.				
03	Feb.23, 2007	K.Okada	K.Okada	T.Anzai	Refer to Revision Record on page 2.				
						DRAW. No.	P1PA03334-B30X/6		CUST.
Rev	DATE	DESIG.	CHECK	APPR.	DESCRIPTION	PFU LIMITED		PAGE	135/138
DESIG	Aug.19, 2005	K.Okada	CHECK	K.Okada	APPR.				

When using a scanner, the following message may be displayed.

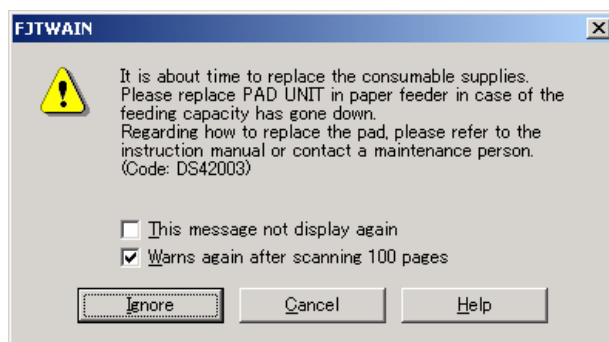

If this message appears, replace consumables following the instructions below.

< If replacing consumables immediately >

1. Check [This message not display again].
2. In cases where consumables are replaced after completing all documents being scanned, click [Ignore]. In cases where scanning is stopped for an immediate replacement, click [Cancel].
3. Following [Section 1-8](#), replace the consumables.
4. Select [Page counter] from [Device setup], click [Clear] button to reset the consumables counter.

Note: When [This message not display again.] is marked, the message will not appear until the consumable counter is reset and it reaches the specified value (Pad: 90,000 sheets, Pick roller: 190,000sheets).

< If replacing later (immediate replacement is impossible) >

1. If it is not necessary to display this message again, check [This message not display again]*. If it is necessary to display this message again after scanning xxx pages, check [Warns again after scanning xxx pages].
2. If the scanning is continued, click [Ignore] and close the message. If the scanning is stopped, click [Cancel] and close the message.
3. Replace consumables as soon as possible or when this message appears next time.
4. After the replacement, click [Clear] of [Device Setup] under [Page Counter] to reset the consumables counter.

(* If [This message not display again] is checked, this message will not appear before the consumables counter is reset.)

◆ **Power saving:**

Specify when the lamp turns off. This is the elapsed time after a scan is complete.

05	Nov. 20, 2008	K.Okada	T.Anzai	I.Fujioka	Refer to Revision Record on page 2.	TITLE	fi-5530C/fi-5530C2 IMAGE SCANNER MAINTENANCE MANUAL		
04	July 7, 2008	K.Okada	T.Anzai	I.Fujioka	Refer to Revision Record on page 2.				
03	Feb.23, 2007	K.Okada	K.Okada	T.Anzai	Refer to Revision Record on page 2.				
						DRAW. No.	P1PA03334-B30X/6		CUST.
Rev	DATE	DESIG.	CHECK	APPR.	DESCRIPTION	PFU LIMITED		PAGE	136/138
DESIG	Aug.19, 2005	K.Okada	CHECK	K.Okada	APPR.			T.Anzai	

◆ **[Multi feed] button**

Use this to specify multi feed detection area.

Normally Multi feed detection will monitor paper overlap over the whole area of the document. This will lead to certain documents such as postcards being mistakenly detected as multi feed because some portion of the document is pasted with photographs or stamps. When scanning these kinds of documents, you can specify an exact detection area to prevent mis-detection.

Click on the button and the following screen will appear.

Enable (Detection Area Selection)

Vertically select an area where multi feed detection will or will not be conducted. Choose wither “Select area for applying Multi feed Detection” or “Select area for not applying Multi feed detection”.

- Select area for applying Multi feed Detection:

Select an area for multi feed detection.

- Select area for not applying Multi feed Detection

Select an area not to be detected.

- Start

Set start position as distance from the document’s top page.
(Possible values: 0-510mm with Start Position <End Position)

- End

Set end position as distance from the document’s top page.
(Possible values: 0-510mm with Start Position <End Position)

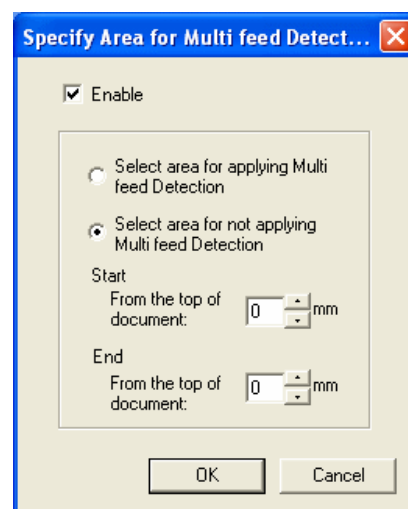

◆ **[Power Control] button**

Enable/Disable the scanner’s power switch.

- Enable Power Switch

Scanner power switch is enabled.
The scanner can be turned ON/OFF by the power switch.

- Disable Power Switch

Scanner power switch is disabled.
The scanner will be turned ON/OFF by connecting/disconnecting the power supply.
(Power button will no longer work).

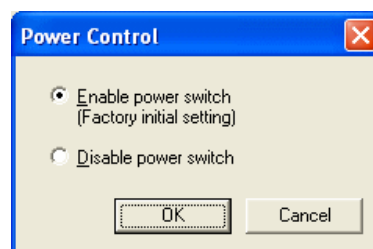

05	Nov. 20, 2008	K.Okada	T.Anzai	I.Fujioka	Refer to Revision Record on page 2.	TITLE	fi-5530C/fi-5530C2 IMAGE SCANNER MAINTENANCE MANUAL		
04	July 7, 2008	K.Okada	T.Anzai	I.Fujioka	Refer to Revision Record on page 2.				
03	Feb.23, 2007	K.Okada	K.Okada	T.Anzai	Refer to Revision Record on page 2.				
						DRAW. No.	P1PA03334-B30X/6		CUST.
Rev	DATE	DESIG.	CHECK	APPR.	DESCRIPTION	PFU LIMITED		PAGE	137/138
DESIG	Aug.19, 2005	K.Okada	CHECK	K.Okada	APPR. T.Anzai				

◆ [Offset] button

When this button is clicked, the following dialog box is displayed.

Using this dialog box, the offset of the leading edge and magnification for the sub-scanning direction can be changed.

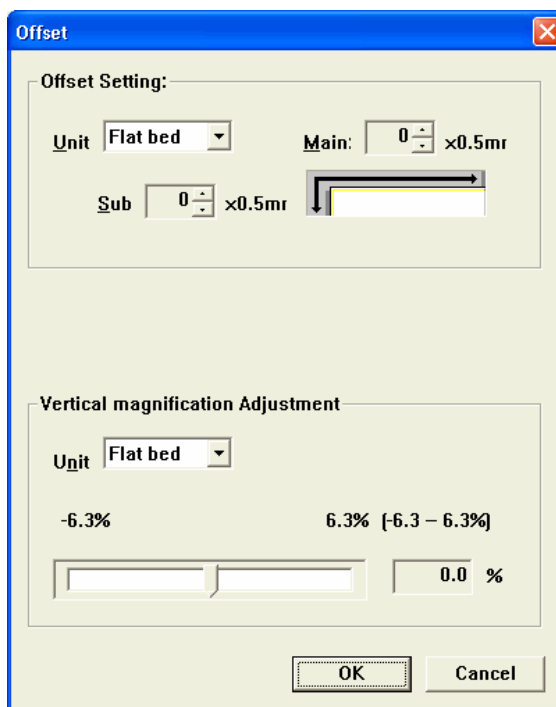

- Offset Setting:

If the position of the scanned image shifts from the original document, fine adjustment is possible. At shipment, the offset has been adjusted to an optimum value within a certain range. Therefore, adjustment is not generally required.

- Vertical magnification Adjustment

The vertical magnification correction value of sub-scanning direction can be changed. The image is expanded or shrunk in the paper feeding direction based on the setting value at shipment. This function is used to adjust the image whose ratio of length and width seems different from the original document.

- [OK] button

The adjusted value is written to the EEPROM.

A.7 About Tab

The version of this driver and a link to the Fujitsu home page are displayed.

A.8 Color Management Tab Folder

Color profiles assigned to the device can be added or deleted from this folder. "sRGB Color Space Profile.icm" is the default driver assigned to this driver.

05	Nov. 20, 2008	K.Okada	T.Anzai	I.Fujioka	Refer to Revision Record on page 2.	TITLE	fi-5530C/fi-5530C2 IMAGE SCANNER MAINTENANCE MANUAL		
04	July 7, 2008	K.Okada	T.Anzai	I.Fujioka	Refer to Revision Record on page 2.	DRAW. No.	P1PA03334-B30X/6		CUST.
03	Feb.23, 2007	K.Okada	K.Okada	T.Anzai	Refer to Revision Record on page 2.				
Rev	DATE	DESIG.	CHECK	APPR.	DESCRIPTION	PFU LIMITED		PAGE	138/138
DESIG	Aug.19, 2005	K.Okada	CHECK	K.Okada	APPR. T.Anzai				