

Block Diagram

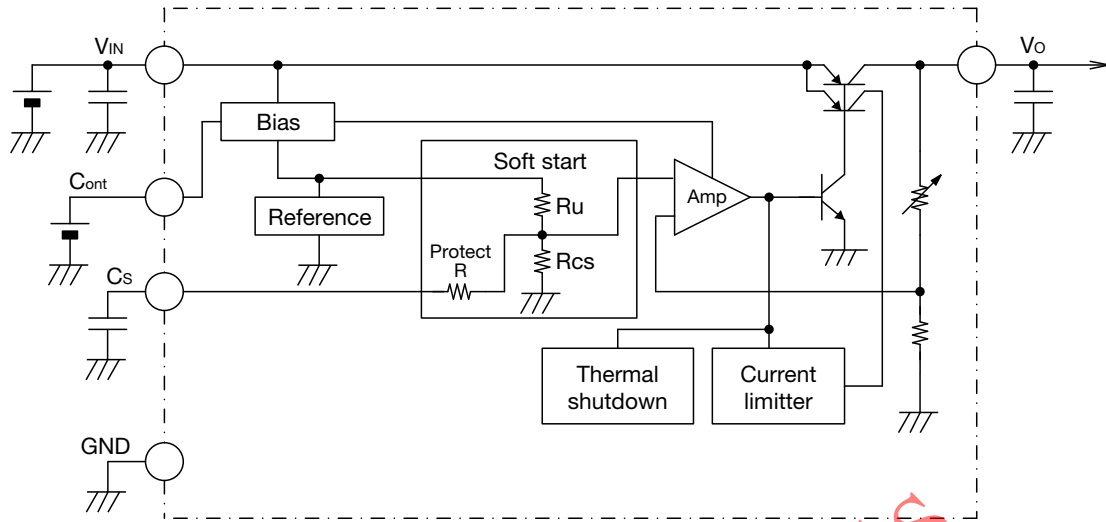

Pin Assignment

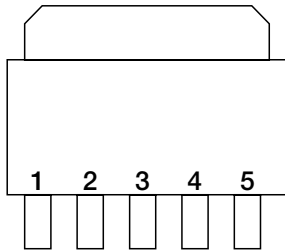

TO-252-5
(TOP VIEW)

1	Cont
2	V _{IN}
3	GND
4	V _O
5	C _s

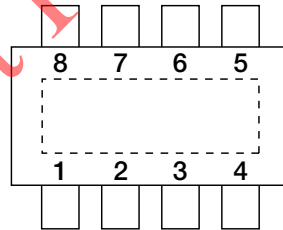

HSOP-8A
(TOP VIEW)

1	V _O
2	NC
3	GND
4	C _s
5	Cont
6	NC
7	NC
8	V _{IN}

Phased Out Products

Pin Description

TO-252-5

Pin No.	Pin name	Functions
1	Cont	ON/OFF-Control pin
		Cont OUTPUT
		Low OFF
		High ON
Connect Cont pin with V _{IN} pin, when it is not used.		
2	V _{IN}	Voltage-supply pin
3	GND	Ground
4	V _O	Output pin
5	Cs	Soft-start pin

HSOP-8A

Pin No.	Pin name	Functions
1	V _O	Output pin
2	NC	No connection
3	GND	Ground
4	Cs	Soft-start pin
5	Cont	ON/OFF-Control pin
		Cont OUTPUT
		Low OFF
		High ON
Connect Cont pin with V _{IN} pin, when it is not used.		
6	NC	No connection
7	NC	No connection
8	V _{IN}	Voltage-supply pin

Absolute Maximum Ratings (Except where noted otherwise Ta=25°C)

Item	Symbol	Ratings	Units
Storage Temperature	T _{STG}	-40~+150	°C
Supply Voltage	V _{IN}	13.2	V
Power Dissipation	Pd	2.5(Note1)	TO-252-5
		1.8(Note2)	HSOP-8A
			W

Note1 : With the double sided PC Board of glass epoxy
(Copper plane 80%, 150 × 100 × 1.0mm)

Note2 : With the double sided PC Board of glass epoxy
(Copper plane 80%, 37 × 37 × 1.6mm)

Recommended Operating Conditions (Except where noted otherwise Ta=25°C)

Item	Symbol	Ratings	Units
Operating Ambient Temperature	T _{JOP}	-40~85	°C
Operating Voltage	V _{OP}	V _O <2.0V 2.4~12	V
		V _O ≥2.0V V _O (typ.)+0.5~12	
Output Current	I _O	0~1	A

Electrical Characteristics 2 (Except where noted otherwise $V_{IN}=V_O+0.5V$, $I_O=1mA$, $T_a=25^\circ C$)

Model No.	Measurement Conditions	Output Voltage (V)			
		Min.	Typ.	Max.	
MM1921C	$T_a=25^\circ C$ $V_{IN}=2.4V$ $I_O=250mA$	1.170	1.2	1.230	
MM1921Z		1.230	1.26	1.290	
MM1921D		1.270	1.3	1.330	
MM1921E		1.370	1.4	1.430	
MM1921F		1.470	1.5	1.530	
MM1921G		1.568	1.6	1.632	
MM1921H		1.666	1.7	1.734	
MM1921J		1.764	1.8	1.836	
MM1921K		1.862	1.9	1.938	
MM1922A		$T_a=25^\circ C$ $V_{IN}=V_O+1V$ $I_O=250mA$	1.960	2.0	2.040
MM1922B			2.058	2.1	2.142
MM1922C	2.156		2.2	2.244	
MM1922D	2.254		2.3	2.346	
MM1922E	2.352		2.4	2.448	
MM1922F	2.450		2.5	2.550	
MM1922G	2.548		2.6	2.652	
MM1922H	2.646		2.7	2.754	
MM1922J	2.744		2.8	2.856	
MM1922K	2.842		2.9	2.958	
MM1923A	2.940		3.0	3.060	
MM1923B	3.038		3.1	3.162	
MM1923C	3.136		3.2	3.264	
MM1923D	3.234		3.3	3.366	
MM1923E	3.332		3.4	3.468	
MM1923F	3.430		3.5	3.570	
MM1923G	3.528		3.6	3.672	
MM1923H	3.626		3.7	3.774	
MM1923J	3.724		3.8	3.876	
MM1923K	3.822		3.9	3.978	
MM1924A	3.920		4.0	4.080	
MM1924B	4.018		4.1	4.182	
MM1924C	4.116		4.2	4.284	
MM1924D	4.214	4.3	4.386		
MM1924E	4.312	4.4	4.488		
MM1924F	4.410	4.5	4.590		
MM1924G	4.508	4.6	4.692		
MM1924H	4.606	4.7	4.794		
MM1924J	4.704	4.8	4.896		
MM1924K	4.802	4.9	4.998		
MM1925A	4.900	5.0	5.100		
MM1925B	4.998	5.1	5.202		
MM1923W	3.283	3.35	3.417		
MM1923Y	3.773	3.85	3.927		

Phased Out Products

About Power Dissipation

This IC's GND pin and Heat Spreader Bottom effectively radiate heat. By increasing these copper foil pattern area of PCB, Power dissipation improves. Please kindly design PCB pattern taking care of above features about power dissipation.

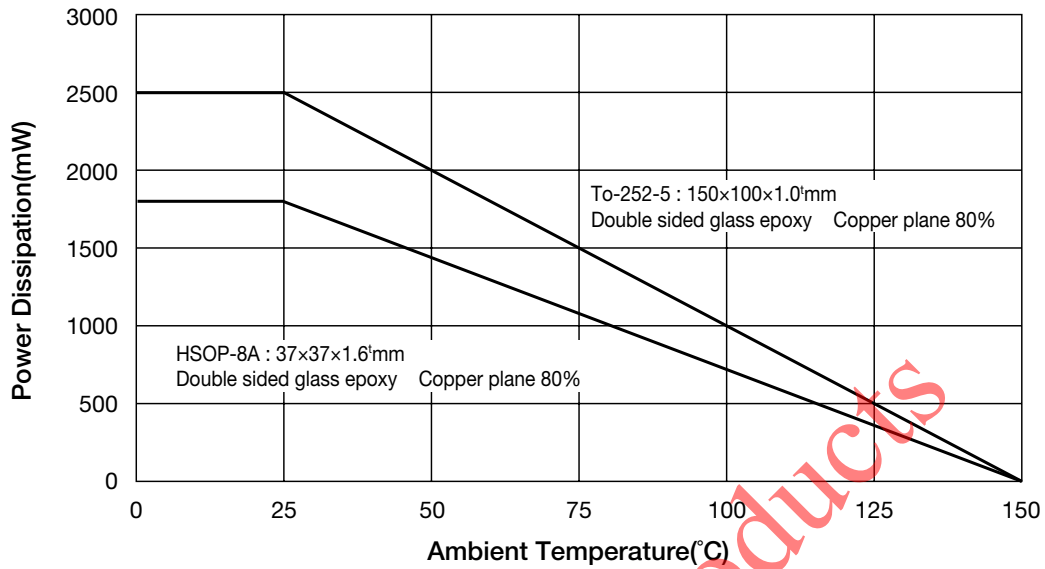

Land Pattern Recommendation

HSOP-8A

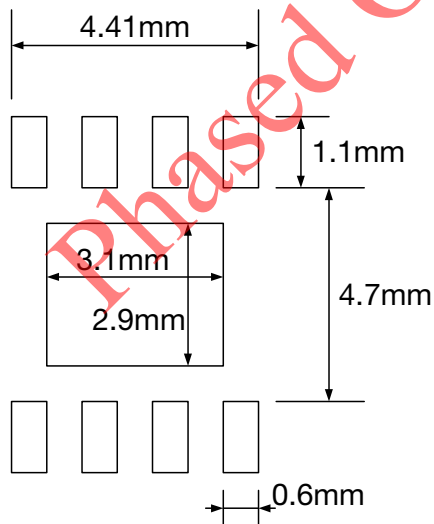

TO-252-5

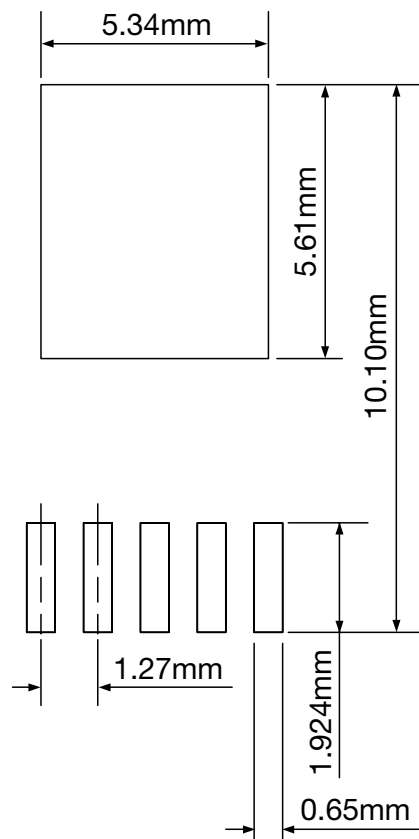

Note : These Dimensions are the reference values.

Output voltage - Temperature

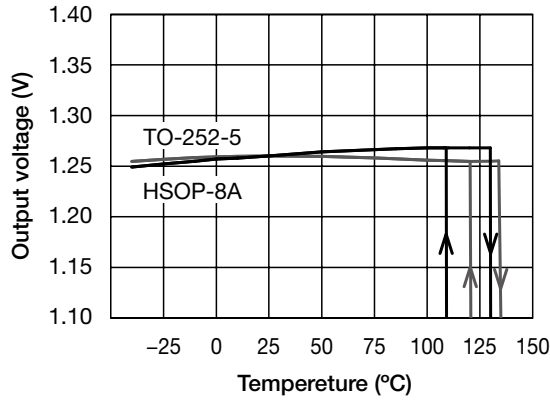

Output rise time

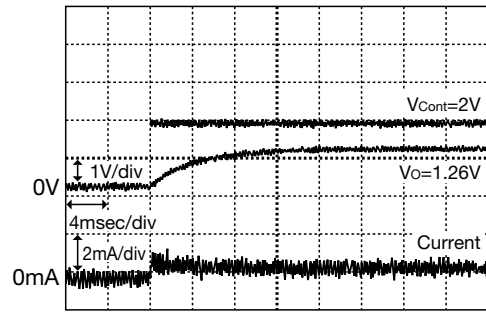

Rush current peak level

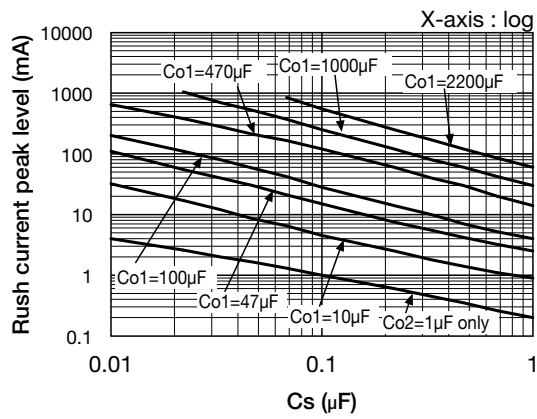

* Please refer to NOTE 7,8.

ESR Stable area

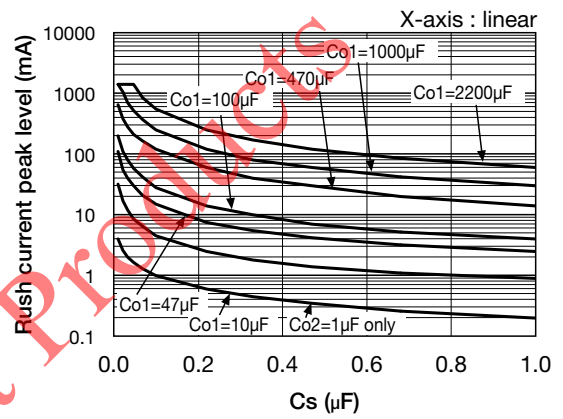

* Please refer to NOTE 7,8.

Phased Out Product

Characteristics (Vo=3.3V) (Except where noted otherwise $V_{IN}=V_O+1V$, $V_{Cont}=V_{IN}$, $C_{in}=1.0\mu F$, $C_o=1.0\mu F$, $C_s=0.1\mu F$, $T_a=25^\circ C$)

■ Output - Input voltage

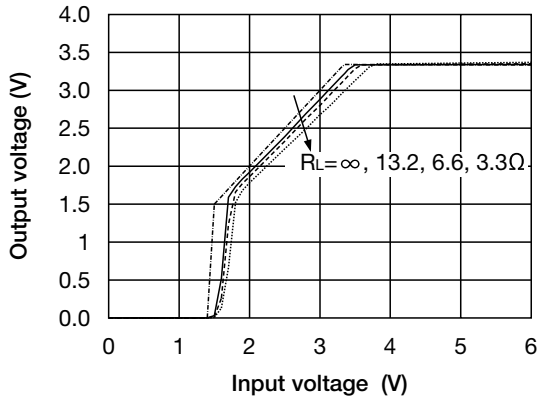

■ Line regulation

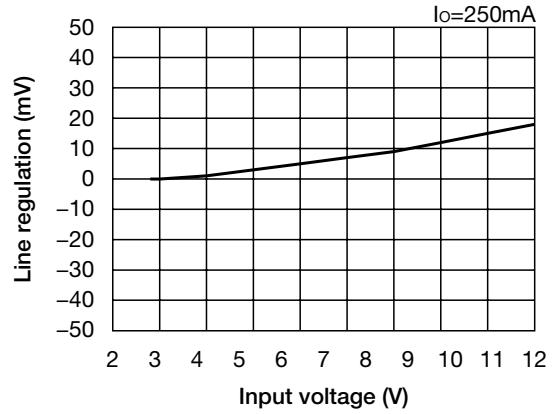

■ Load current - Output voltage

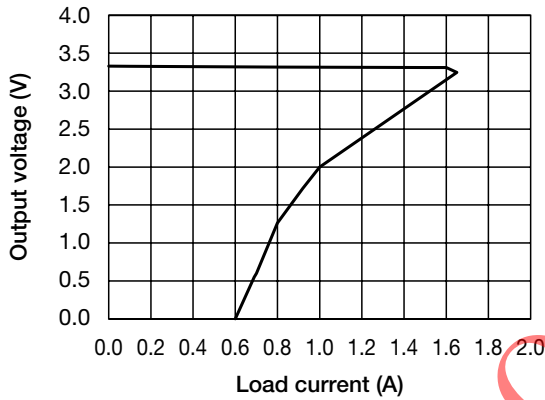

■ Load regulation



■ Input voltage - Input current

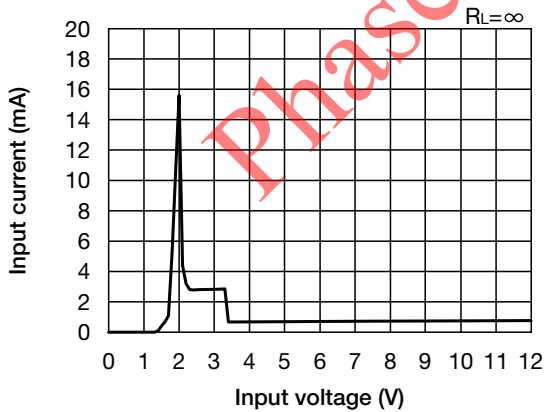

■ Dropout voltage

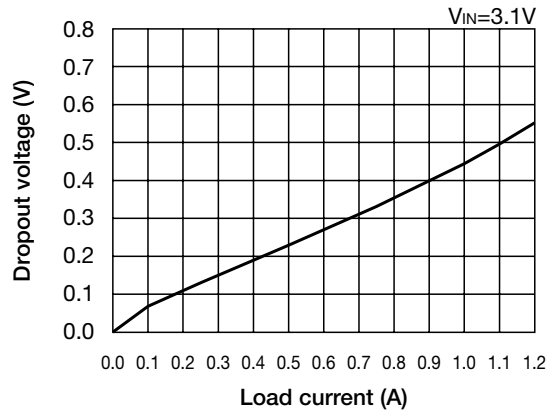

Output voltage - Temperature

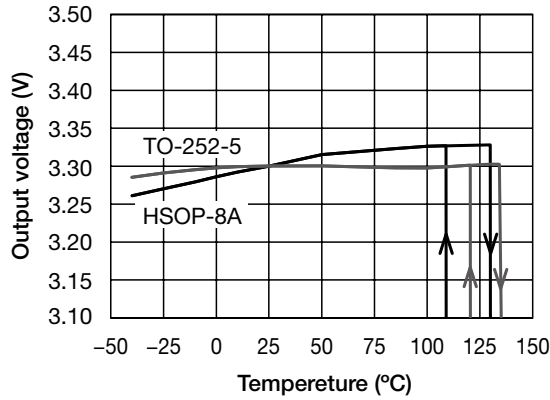

Output rise time

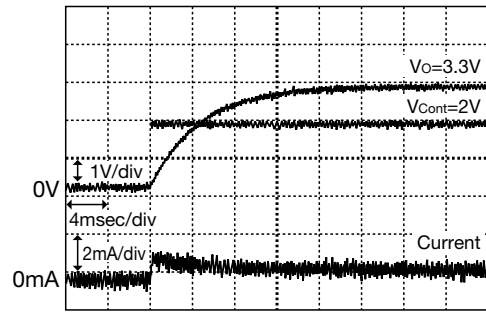

Rush current peak level

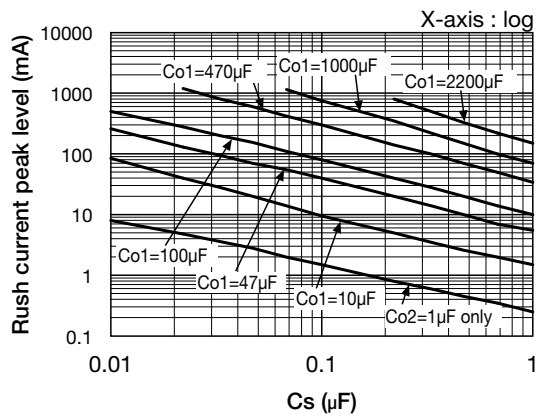

* Please refer to NOTE 7,8.

Rush current peak level

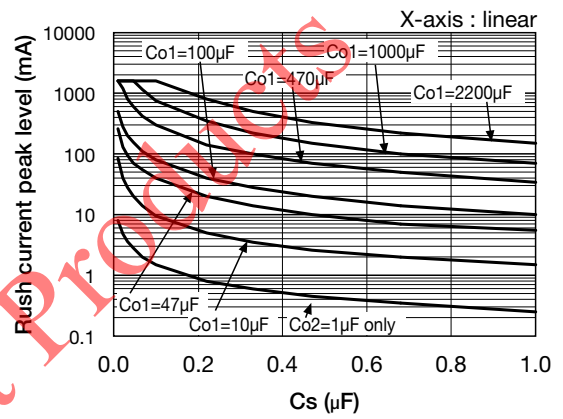

* Please refer to NOTE 7,8.

Phased Out Product

Characteristics (Vo=5.1V) (Except where noted otherwise $V_{IN}=V_O+1V$, $V_{Cont}=V_{IN}$, $C_{in}=1.0\mu F$, $C_o=1.0\mu F$, $C_s=0.1\mu F$, $T_a=25^\circ C$)

Output - Input voltage

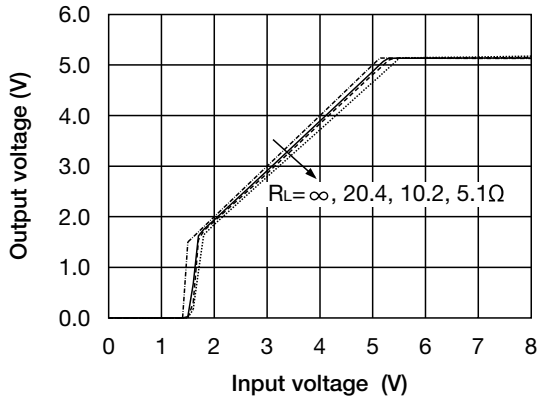

Line regulation

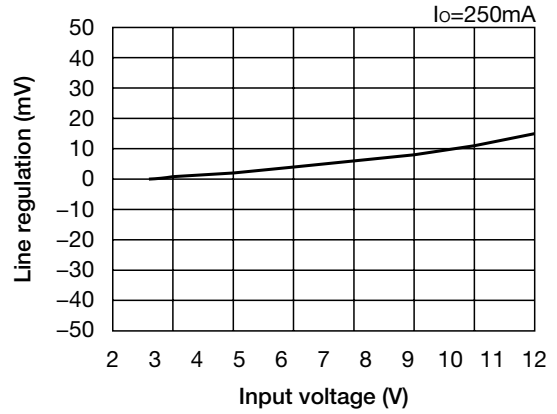

Load current - Output voltage

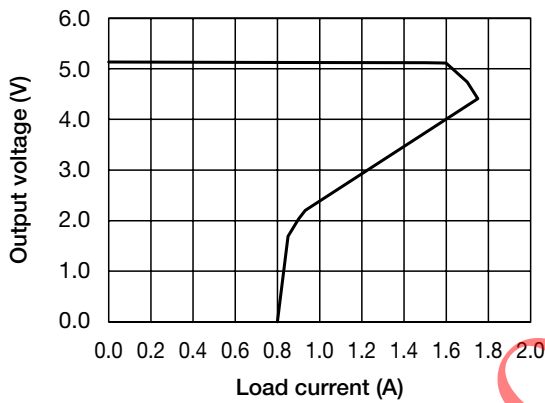

Load regulation



Input voltage - Input current

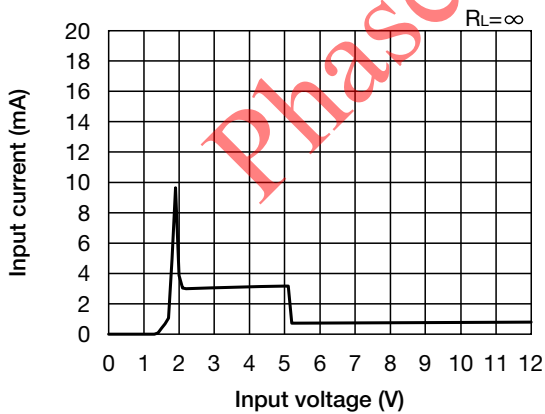

Dropout voltage

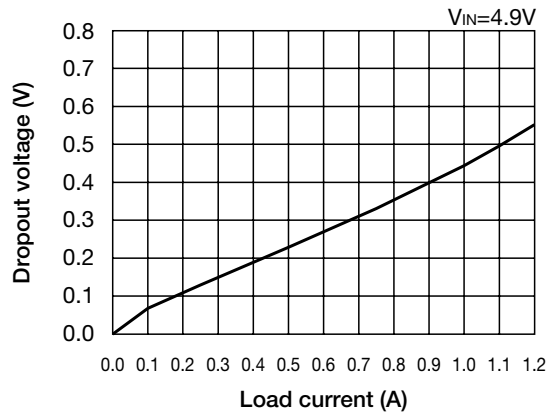

Output voltage - Temperature

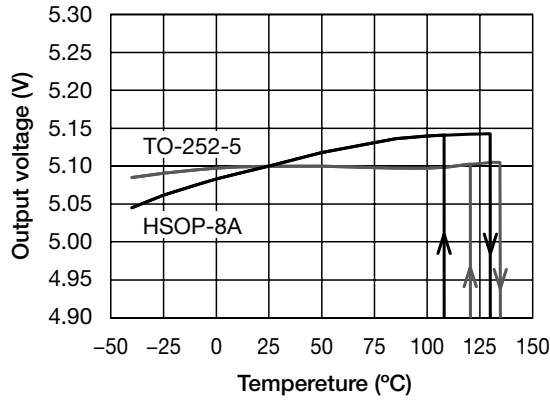

Output rise time

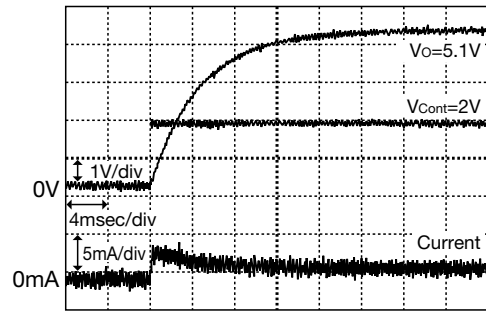

Rush current peak level

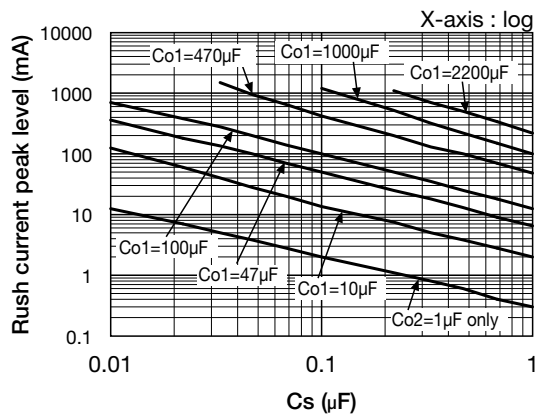

* Please refer to NOTE 7,8.

Rush current peak level

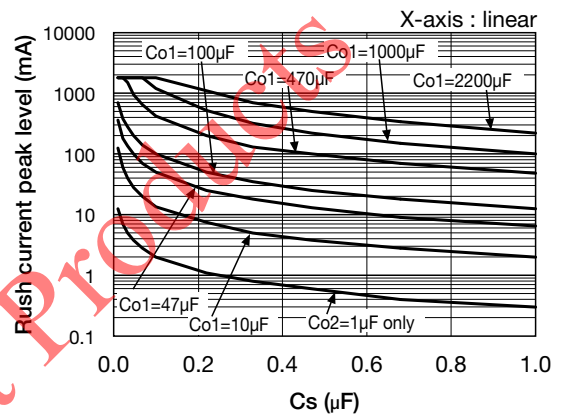

* Please refer to NOTE 7,8.

Phased Out Product

Characteristics (Except where noted otherwise $V_{IN}=V_O+1V$, $V_{Cont}=V_{IN}$, $C_{in}=1.0\mu F$, $C_O=1.0\mu F$, $C_s=0.1\mu F$, $T_a=25^\circ C$)

Ripple Rejection

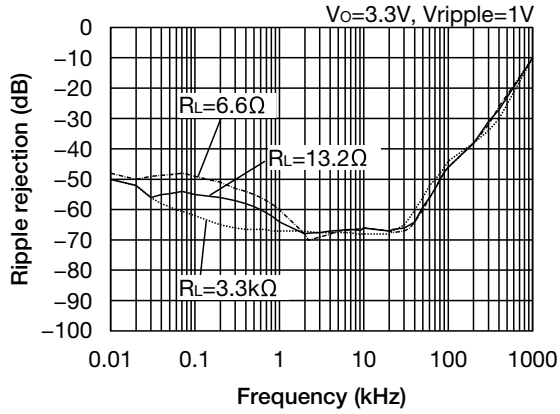

Ripple Rejection

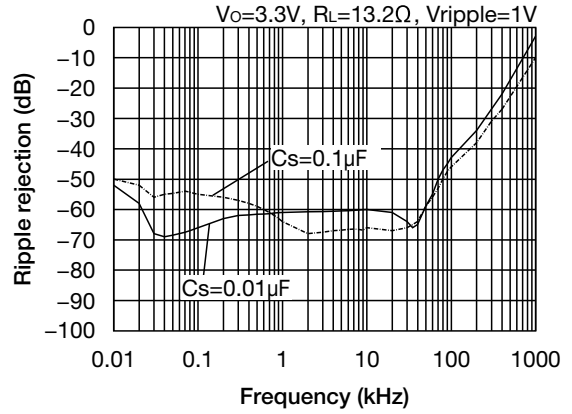

Output rise time

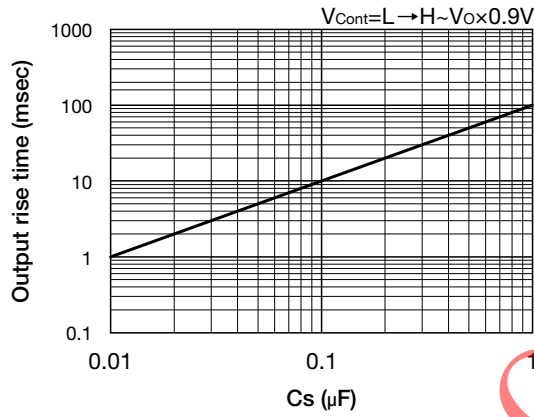

Load regulation

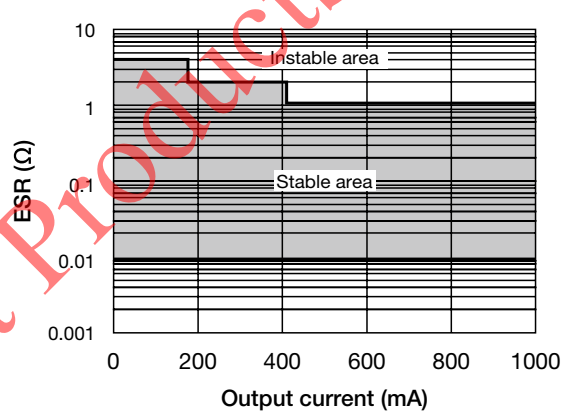

Phased Out Products