

CERAMIC SURGE ABSORBERS (VARISTORS)

SVC

SVC CHARACTERISTIC

• INTRODUCTION

SVC series Varistors are gapless ceramic surge absorbers of a new type made of metal oxide which is designed to protect various kinds of electronic devices and semiconducting elements from surges.

• FEATURES

1. High discharge current capability up to 4000 Amps.
2. Excellent clamping characteristics.
3. Fast response time under 50 nanoseconds.
4. Improve product safety
5. UL, CSA, VDE recognized

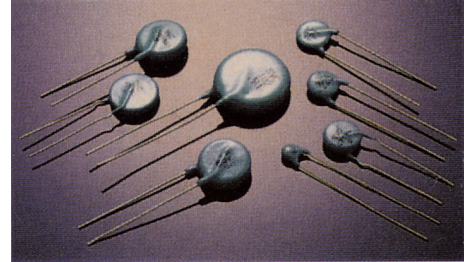

TYPE DESIGNATION (HOW TO ORDER)

SVC 471 D-14A FF 7

Basic Type
ZnO Varistor

Varistor Nominal Voltage
(The first two digit indicate significant digits)
(The 3rd digit indicate the number of zeros following)

Style
D : Disk Type Varistor

Lead Spacing & Pitch of Component

Packing Style & Lead Variation

Classification
A : High Voltage(82V and above)
B : Low Voltage(less then 68V)

Chip Element Size (Dia)
05 : ϕ 5mm 14 : ϕ 14mm
07 : ϕ 7mm 20 : ϕ 20mm
10 : ϕ 10mm

Packing Style		Lead Variation		Packing Style		Lead Variation	
F	Taping Type Flat Pack	S	Straight Type	B	Bulk	S	Straight Long Type
		K	In-Kink Type			W	Kink short Type
		F	Out-Kink Type			K	Kink long Type
						L	Kink short Type
						N	Straight short Type

* Suffix Code

Taping Type	Code	5	7	8	9	1
	Lead Spacing(mm)	5.0	7.5	7.5	7.5	10.0
	Pitch of Component(mm)	12.7	15.0	30.0	25.4	30.0
Bulk Type	Code	5	7	1		
	Lead Spacing(mm)	5.0	7.5	10.0		

CERAMIC SURGE ABSORBERS (VARISTORS)

SVC

SVC CHARACTERISTIC CURVES

V - I CURVE

- Small - current region of V - I curve

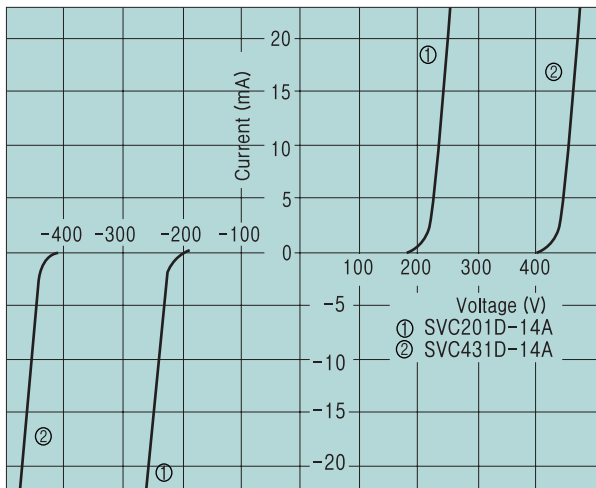

- Temporary power frequency over voltage capability

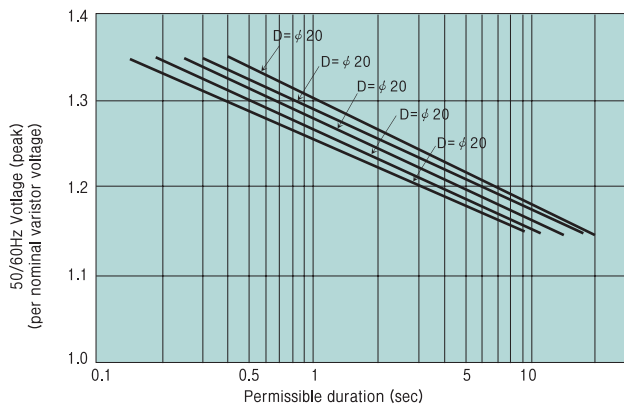

B TYPE

- Withstand discharge impulse current characteristics (Typical)

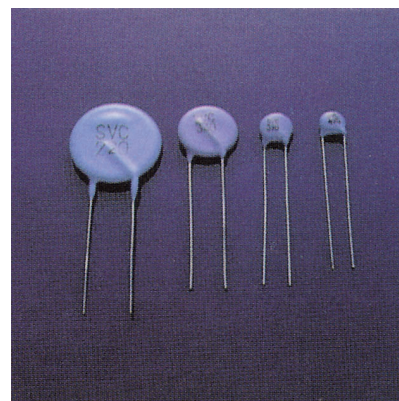
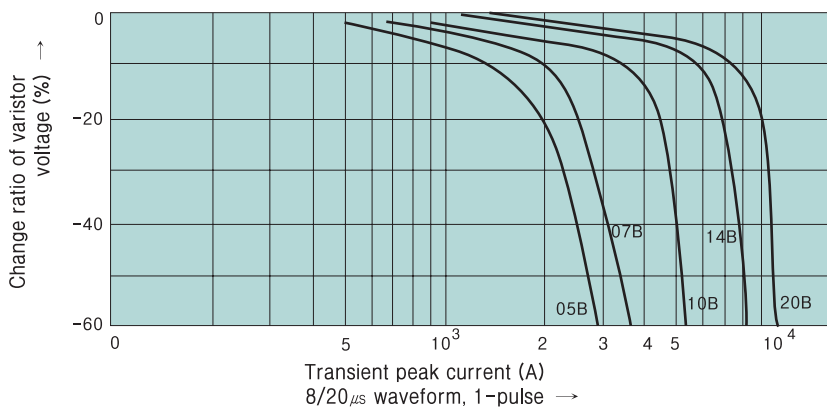

A TYPE

- Withstand discharge impulse current characteristics (Typical)

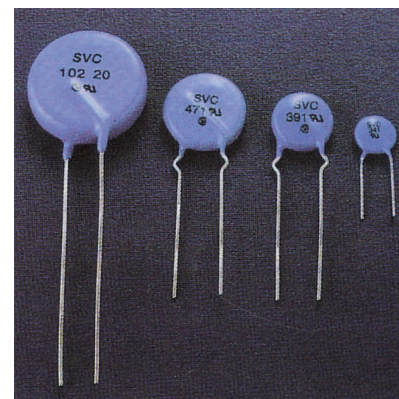
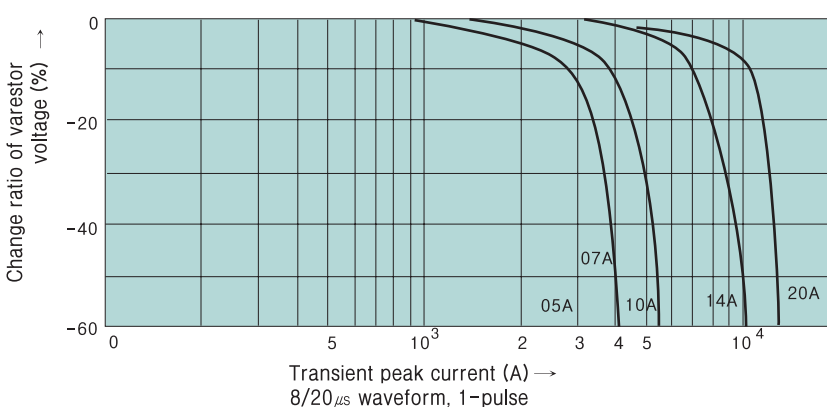

CERAMIC SURGE ABSORBERS (VARISTORS)

SVC

SPECIFICATION

Device Type	Chip Element Size	Maximum ratings					Characteristics					
		Applied voltage		Transient			Nominal varistor ^④ peak voltage			Max. clamping ^⑤ voltage @ test current (8/20 μ s)		Typical capacitance
		RMS 50/60Hz (25 °C)	DC (25 °C)	Energy ^②	Average power dissipation	Peak ^③ current (8/20 μ s)						
		Dia (mm)	V _{acm} (Volts)	V _{dcm} (Volts)	W _{tm} (Joules)	P _{tam} (Watts)	I _{tm} (Amps)	V _{nom} (Volts)	Tolerance		V _c (Volts)	I _p (Amps)
Min (Volts)	Max (Volts)											
SVC 180D-05B	5	11	14	0.3	0.01	125	18	16	20	40	1	1700
SVC 180D-07B	7			0.8	0.02	250				36	2.5	3500
SVC 180D-10B	10			1.5	0.05	500				36	5	7000
SVC 180D-14B	14			3.5	0.1	1000				36	10	1400
SVC 180D-20B	20			10.0	0.2	2000				36	20	28000
SVC 220D-05B	5	14	18	0.4	0.01	125	22	20	24	48	1	1200
SVC 220D-07B	7			0.9	0.02	250				43	2.5	2500
SVC 220D-10B	10			2.0	0.05	500				43	5	5000
SVC 220D-14B	14			4.0	0.1	1000				43	10	11000
SVC 220D-20B	20			13.0	0.2	2000				43	20	22000
SVC 270D-05B	5	17	22	0.5	0.01	125	27	24	30	60	1	1100
SVC 270D-07B	7			1.0	0.02	250				53	2.5	2000
SVC 270D-10B	10			2.5	0.05	500				53	5	4500
SVC 270D-14B	14			5.0	0.1	1000				54	10	9000
SVC 270D-20B	20			15.0	0.2	2000				53	20	18000
SVC 330D-05B	5	20	26	0.6	0.01	125	33	30	36	73	1	1000
SVC 330D-07B	7			1.2	0.02	250				65	2.5	2000
SVC 330D-10B	10			3.0	0.05	500				65	5	4000
SVC 330D-14B	14			6.0	0.1	1000				65	10	8000
SVC 330D-20B	20			20.0	0.2	2000				65	20	16000
SVC 390D-05B	5	25	31	0.8	0.01	125	39	35	43	86	1	800
SVC 390D-07B	7			1.5	0.02	250				77	2.5	1600
SVC 390D-10B	10			3.5	0.05	500				77	5	3200
SVC 390D-14B	14			7.0	0.1	1000				77	10	6500
SVC 390D-20B	20			24.0	0.2	2000				77	20	13000
SVC 470D-05B	5	30	38	1.0	0.01	125	47	42	52	104	1	700
SVC 470D-07B	7			1.8	0.02	250				93	2.5	1400
SVC 470D-10B	10			4.5	0.05	500				93	5	2800
SVC 470D-14B	14			8.5	0.1	1000				93	10	5500
SVC 470D-20B	20			30.0	0.2	2000				93	20	11000
SVC 560D-05B	5	35	45	1.0	0.01	125	56	50	62	123	1	600
SVC 560D-07B	7			2.2	0.02	250				110	2.5	1300
SVC 560D-10B	10			5.5	0.05	500				110	5	2500
SVC 560D-14B	14			10.5	0.1	1000				110	10	5000
SVC 560D-20B	20			35.0	0.2	2000				110	20	10000
SVC 680D-05B	5	40	56	1.2	0.01	125	68	61	75	150	1	500
SVC 680D-07B	7			2.5	0.02	250				135	2.5	1000
SVC 680D-10B	10			6.5	0.05	500				135	5	2000
SVC 680D-14B	14			12.0	0.1	1000				135	10	4000
SVC 680D-20B	20			40.0	0.2	2000				135	20	8000
SVC 820D-05B	5	50	65	1.7	0.1	250	82	74	90	145	5	400
SVC 820D-07B	7			3.5	0.25	600				135	10	800
SVC 820D-10B	10			8.0	0.4	1250				135	25	1500
SVC 820D-14B	14			14.0	0.6	2500				135	50	3000
SVC 820D-20B	20			27.0	1.0	4000				135	100	6000
SVC 101D-05B	5	60	85	2.0	0.1	250	100	90	110	175	5	350
SVC 101D-07B	7			4.0	0.25	600				165	10	700
SVC 101D-10B	10			10.0	0.4	1250				165	25	1500
SVC 101D-14B	14			18.0	0.6	2500				165	50	3000
SVC 101D-20B	20			30.0	1.0	4000				165	100	6000
SVC 121D-05B	5	75	100	2.5	0.1	250	120	108	132	210	5	350
SVC 121D-07B	7			5.0	0.25	600				200	10	700
SVC 121D-10B	10			12.0	0.4	1250				200	25	1300
SVC 121D-14B	14			20.0	0.6	2500				200	50	2600
SVC 121D-20B	20			40.0	1.0	4000				200	100	5200
SVC 151D-05B	5	95	125	3.0	0.1	250	150	135	165	260	5	250
SVC 151D-07B	7			6.0	0.25	600				250	10	500
SVC 151D-10B	10			16.0	0.4	1250				250	25	1000
SVC 151D-14B	14			25.0	0.6	2500				250	50	2000
SVC 151D-20B	20			50.0	1.0	4000				250	100	4000
SVC 201D-05B	5	130	170	4.0	0.1	250	200	185	225	355	5	200
SVC 201D-07B	7			10.0	0.25	600				340	10	400
SVC 201D-10B	10			20.0	0.4	1250				340	25	800
SVC 201D-14B	14			35.0	0.6	2500				340	50	1600
SVC 201D-20B	20			70.0	1.0	4000				340	100	3200
SVC 221D-05B	5	140	180	4.5	0.1	250	220	198	242	380	5	170
SVC 221D-07B	7			10.0	0.25	600				360	10	350
SVC 221D-10B	10			23.0	0.4	1250				360	25	700
SVC 221D-14B	14			40.0	0.6	2500				360	50	1400
SVC 221D-20B	20			75.0	1.0	4000				360	100	2800
SVC 241D-05B	5	150	200	5.0	0.1	250	240	216	264	415	5	170
SVC 241D-07B	7			10.0	0.25	600				395	10	350
SVC 241D-10B	10			25.0	0.4	1250				395	25	700
SVC 241D-14B	14			40.0	0.6	2500				395	50	1300
SVC 241D-20B	20			80.0	1.0	4000				395	100	2600

CERAMIC SURGE ABSORBERS (VARISTORS)

SVC

Device Type	Dia (mm)	Vacm (Volts)	Vdcm (Volts)	Wtm (Joules)	Ptam (Watts)	Itm (Amps)	Vnom (Volts)	Tolerance		VC (Volts)	Ip (Amps)	f=1kHz (pF)
								Min (Volts)	Max (Volts)			
SVC 271D-05A	5	175	225	6.0	0.1	250	270	247	303	475	5	150
SVC 271D-07A	7			12.0	0.25	600				455	10	300
SVC 271D-10A	10			30.0	0.4	1250				455	25	600
SVC 271D-14A	14			50.0	0.6	2500				455	50	1200
SVC 271D-20A	20			90.0	1.0	4000				455	100	2400
SVC 361D-05A	5	230	300	7.5	0.1	250	360	324	396	620	5	120
SVC 361D-07A	7			15.0	0.25	600				595	10	250
SVC 361D-10A	10			35.0	0.4	1250				595	25	500
SVC 361D-14A	14			65.0	0.6	2500				595	50	1000
SVC 361D-20A	20			120.0	1.0	4000				595	100	2000
SVC 391D-05A	5	250	320	8.0	0.1	250	390	351	429	675	5	110
SVC 391D-07A	7			17.0	0.25	600				650	10	220
SVC 391D-10A	10			40.0	0.4	1250				650	25	450
SVC 391D-14A	14			70.0	0.6	2500				650	50	900
SVC 391D-20A	20			130.0	1.0	4000				650	100	1800
SVC 431D-05A	5	275	350	9.0	0.1	250	430	387	473	754	5	100
SVC 431D-07A	7			20.0	0.25	600				710	10	200
SVC 431D-10A	10			45.0	0.4	1250				710	25	400
SVC 431D-14A	14			75.0	0.6	2500				710	50	800
SVC 431D-20A	20			140.0	1.0	4000				710	100	1600
SVC 471D-05A	5	300	385	10.0	0.1	250	470	423	517	810	5	80
SVC 471D-07A	7			20.0	0.25	600				775	10	170
SVC 471D-10A	10			45.0	0.4	1250				775	25	350
SVC 471D-14A	14			80.0	0.6	2500				775	50	700
SVC 471D-20A	20			150.0	1.0	4000				775	100	1400
SVC 561D-10A	10	350	460	45.0	0.4	1250	560	504	616	920	25	300
SVC 561D-14A	14			85.0	0.6	2500				920	50	600
SVC 561D-20A	20			150.0	1.0	4000				920	100	1200
SVC 621D-10A	10	385	550	45.0	0.4	1250	620	558	682	1025	25	270
SVC 621D-14A	14			85.0	0.6	2500				1025	50	550
SVC 621D-20A	20			150.0	1.0	4000				1025	100	1100
SVC 681D-10A	10	420	560	45.0	0.4	1250	680	612	748	1120	25	250
SVC 681D-14A	14			90.0	0.6	2500				1120	50	500
SVC 681D-20A	20			160.0	1.0	4000				1120	100	1000
SVC 751D-10A	10	460	615	50.0	0.4	1250	750	675	825	1240	25	220
SVC 751D-14A	14			100.0	0.6	2500				1240	50	450
SVC 751D-20A	20			175.0	1.0	4000				1240	100	900
SVC 781D-10A	10	485	640	50.0	0.4	1250	780	702	858	1290	25	220
SVC 781D-14A	14			105.0	0.6	2500				1290	50	440
SVC 781D-20A	20			180.0	1.0	4000				1290	100	880
SVC 821D-10A	10	510	670	55.0	0.4	1250	820	738	902	1355	25	210
SVC 821D-14A	14			110.0	0.6	2500				1355	50	420
SVC 821D-20A	20			190.0	1.0	4000				1355	100	840
SVC 911D-10A	10	550	745	60.0	0.4	1250	910	819	1001	1500	25	180
SVC 911D-14A	14			120.0	0.6	2500				1500	50	380
SVC 911D-20A	20			215.0	1.0	4000				1500	100	750
SVC 102D-10A	10	625	825	65.0	0.4	1250	1000	900	1100	1650	25	180
SVC 102D-14A	14			130.0	0.6	2500				1650	50	350
SVC 102D-20A	20			230.0	1.0	4000				1650	100	700
SVC 112D-10A	10	680	895	70.0	0.4	1250	1100	990	1210	1815	25	150
SVC 112D-14A	14			140.0	0.6	2500				1815	50	300
SVC 112D-20A	20			250.0	1.0	4000				1815	100	600
SVC 182D-10A	14	1000	1465	24.0	0.6	2500	1800	1620	1980	2970	50	200
SVC 182D-14A	20			400.0	1.0	4000				2970	100	400

Notes :

- ① The waveform of the maximum DC applied voltage is flat. When a ripple voltage as from a rectifier source is supplied make sure that the peak voltage is kept under the Vdcm.
An AC applied voltage(50/60Hz) form a sine wvshape.
When the distortion in the waveform is extensive make sure that the peak voltage is less than $\sqrt{2}$ times the Vacm.
- ② Energy : Wtm
Transient energy ratings are given in the Wtm column of the specifications in Joules (watt-second).
The rating is the maximum allowable energy for a single impulse of 2ms square-waveform current with continuous voltage applied. Energy ratings are based on a shift of Vnom of less than $\pm 10\%$ of initial value.
- ③ Transient peak current (Itm)
The peak current rating. Itm. of varistor is based on an 8/20 μ s test impulse wvshape.

This peak current is the maximum peak current in which the normal varistor voltage shift does not exceed $\pm 10\%$ when the test impulse is applied twice at 5 minutes intervals.

- ④ Nominal varistor voltage : Vnom
Indicates the varistor terminal voltage measured with a 1mA DC applied. -0.1mA DC in the case of the 0.5A and 0.5B series.
 - ⑤ Maximum clamping voltage : VC
Indicates the peak terminal voltage measured with an 8/20 μ s impulse current applied.
- Operating ambient temperature : -40C to +80 C
 - Storage temperature : -40 C to +125 C
 - UL and CSA recognized (UL 1449, UL 497B or UL 1414, CSA)
SVC varistors have been tested by Underwriters Laboratories, Inc. and Canadian Standards Association
UL File No. E97754, E151195, E154171.
CSA File No. LR78923.

CERAMIC SURGE ABSORBERS (VARISTORS)

SVC

① FS5 Type

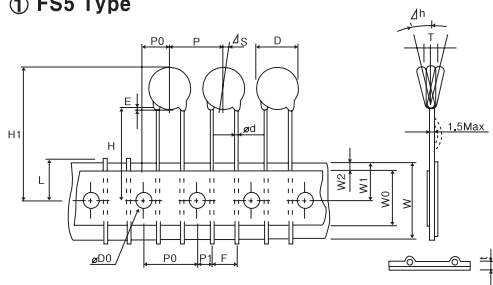

② FK5 Type

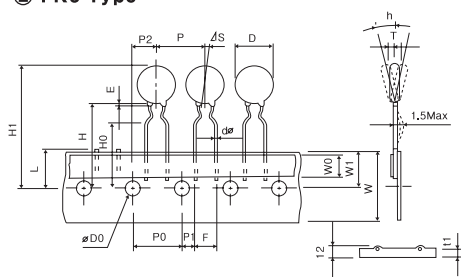

③ FF9 Type

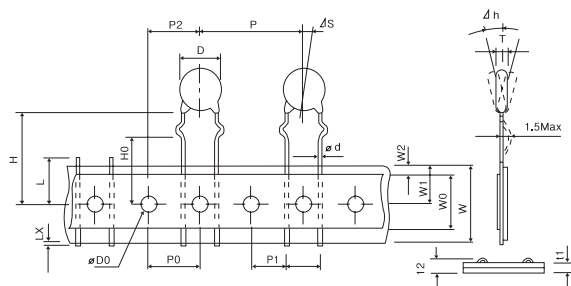

④ FF7 Type

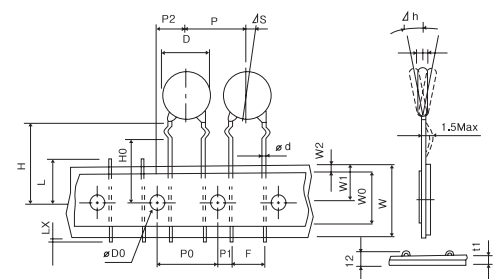

⑤ FF8 Type

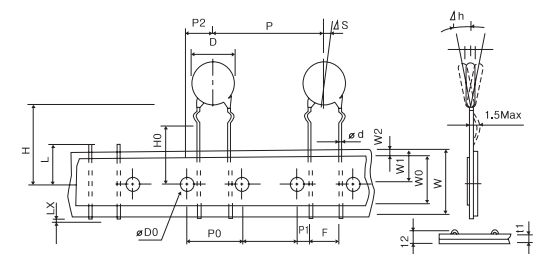

ITEM	Code	Dimensions(mm)	
		FS5, FK5	FF9
Body Diameter	D	See Page 46	
Body thickness	T	See Page 46	
Lead diameter	dφ	0.55±0.05	0.70±0.05
Pitch of sprocket hole	P ₀	12.7±0.3	
Pitch of component	P	6.35±1.3	25.4±1.0
Lead length from hole center to Lead	P ₁	3.85±0.7	8.95±1.0
Lead length from hole center to component center	P ₂	6.35±1.3	12.7±1.5
Lead spacing	F	5.0 ^{+0.8} _{-0.2}	7.5±1.0
Deviation along tape	△S	0±1.0	
Deviation across tape	△h	0±2.0	
Carrier tape width	W	18.0 ^{+1.0} _{-0.5}	
Hold down tape width	W ₀	5.0min 9.0min	
Position of sprocket hole	W ₁	9.0±0.5	
Hold down tape position	W ₂	3.0max	
Lead wire clinch height	H ₀	16.0±0.5	
Height of component hole	H	20.0 ^{+1.5} _{-1.0}	
Component height	H ₁	32.25max	
Diameter of sprocket hole	D ₀	4.0±0.2	
Length of snapped lead	L	11.0max	
Total tape thickness	t ₁	0.7±0.2	
Total thickness tape and lead wire	t ₂	1.5max	1.7max
Length of snapped lead	l _s	1.0max	

ITEM	Code	Dimensions(mm)	
		FF7	FF8
Body Diameter	D	See Page 46	
Body thickness	T	See Page 46	
Lead diameter	dφ	0.70±0.05	
Pitch of sprocket hole	P ₀	15.0±0.3	
Pitch of component	P	15.0±1.0	30.0±1.0
Lead length from hole center to Lead	P ₁	3.75±1.0	
Lead length from hole center to component center	P ₂	7.50±1.5	
Lead spacing	F	7.5±1.0	
Deviation along tape	△S	0±1.0	
Deviation across tape	△h	0±2.0	
Carrier tape width	W	18.0 ^{+1.0} _{-0.5}	
Hold down tape width	W ₀	5.0min	
Position of sprocket hole	W ₁	9.0±0.5	
Hold down tape position	W ₂	3.0max	
Lead wire clinch height	H ₀	16.0±0.5	
Height of component hole	H	20.0 ^{+1.5} _{-1.0}	
Component height	H ₁	40.00max	
Diameter of sprocket hole	D ₀	4.0±0.2	
Length of snapped lead	L	11.0max	
Total tape thickness	t ₁	0.7±0.2	
Total thickness tape and lead wire	t ₂	1.7max	
Length of snapped lead	l _s	1.0max	

SVC

CHAR, CURVES AND LIFETIME

■ TRANSIENT V-I CHARACTERISTIC CURVES

Current waveform Under 10^{-2} A : DC
 Over 10^{-1} A : 8/20 μ s

• 05B (SVC 180D-05B to SVC680D-05B)

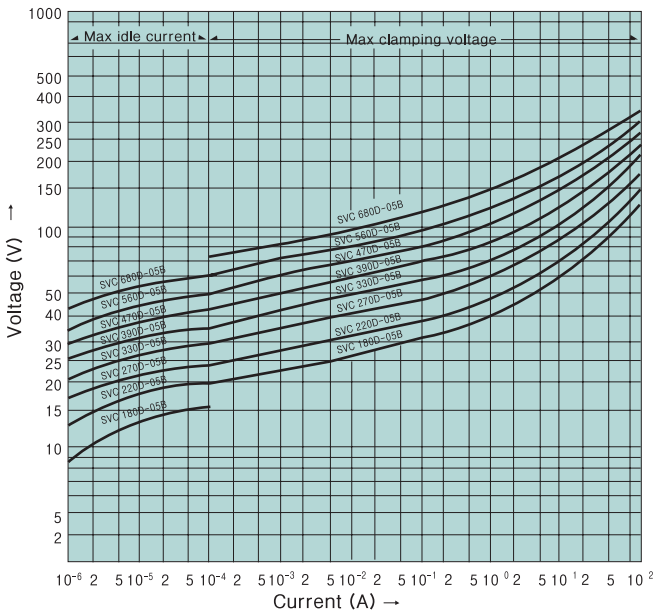

■ PULSE LIFETIME RATINGS

Notes : 2 – pulse : 5 – minute interval
 3 to 10 – pulse : 2 – minute interval
 Up to 10^6 – pulse : 10 – second interval

• 05B (SVC 180D-05B to SVC680D-05B)

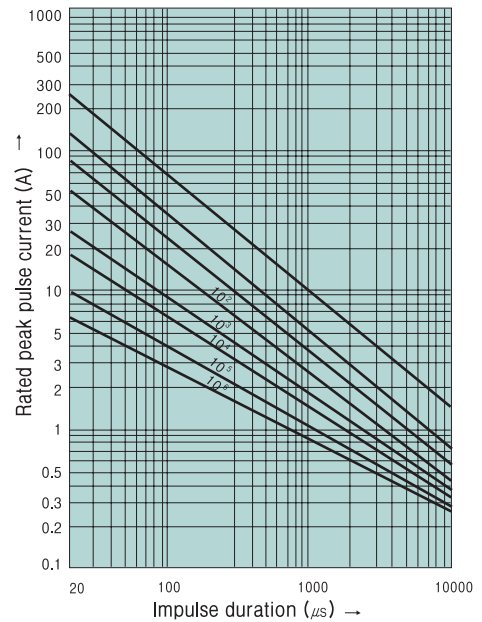

• 05A (SVC 820D-05A to SVC471D-05A)

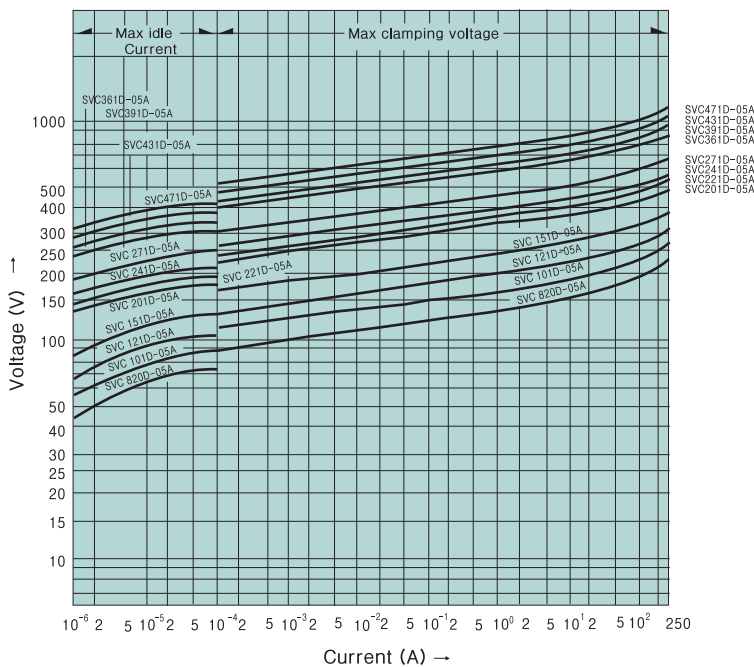

• 05A (SVC 820D-05A to SVC471D-05A)

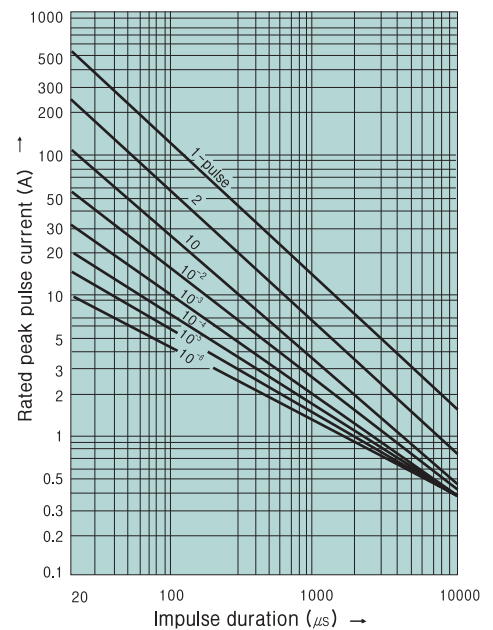

CERAMIC SURGE ABSORBERS (VARISTORS)

SVC

TRANSIENT V-I CHARACTERISTIC CURVES

Current waveform Under 10^{-2} A : DC
 Over 10^{-1} A : $8/20\mu\text{s}$

• 07B (SVC 180D-07B to SVC680D-07B)

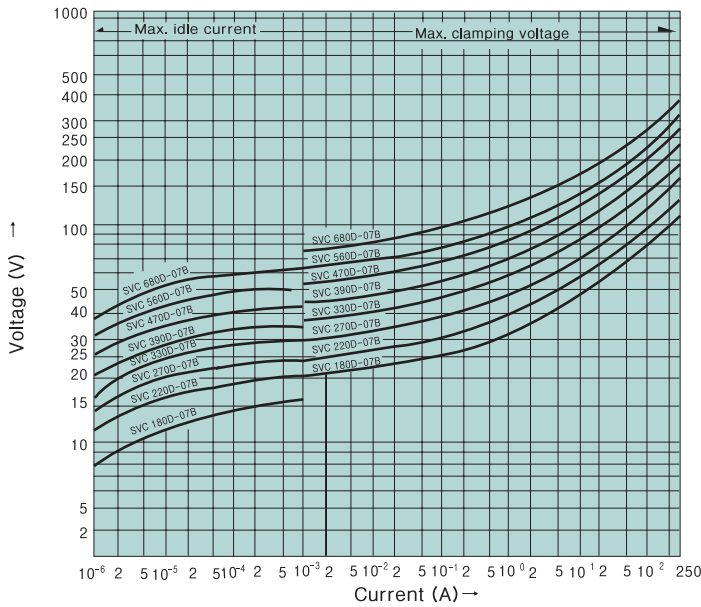

PULSE LIFETIME RATINGS

Notes : 2 - pulse : 5 - minute interval
 3 to 10 - pulse : 2 - minute interval
 Up to 10^6 - pulse : 10 - second interval

• 07B (SVC 180D-07B to SVC680D-07B)

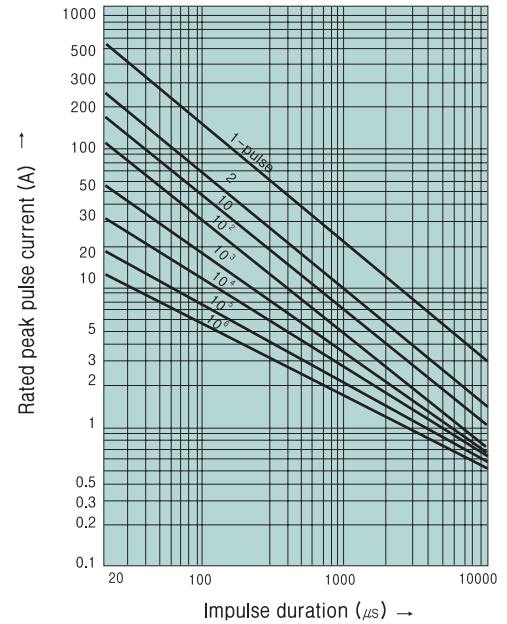

• 07A (SVC 820D-07A to SVC471D-07A)

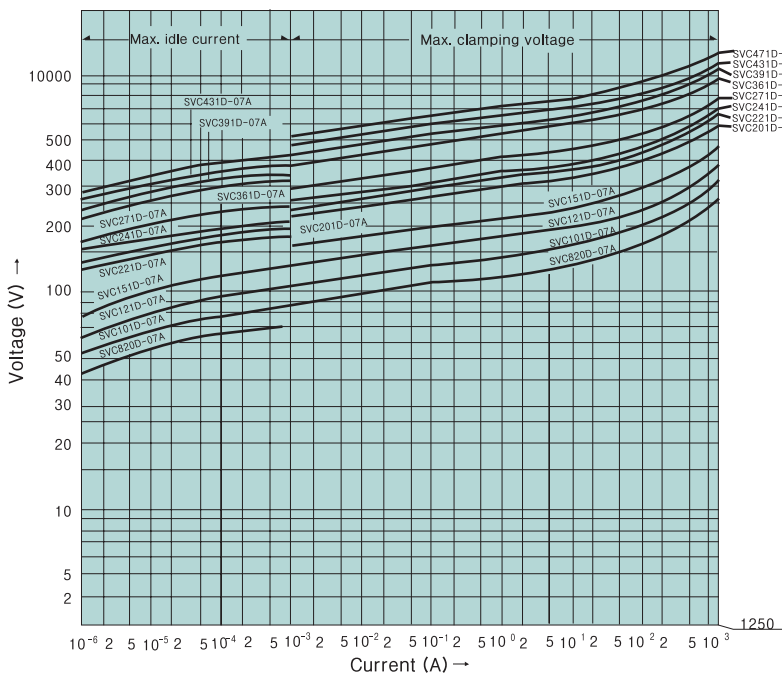

• 07A (SVC 820D-07A to SVC471D-07A)

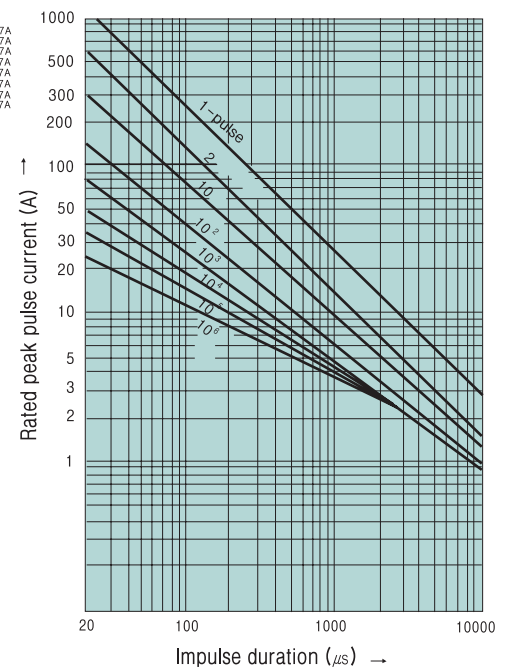

SVC

TRANSIENT V-I CHARACTERISTIC CURVES

Current waveform Under 10^{-2} A : DC
Over 10^{-1} A : 8/20 μ s

• 10B (SVC 180D-10B to SVC680D-10B)

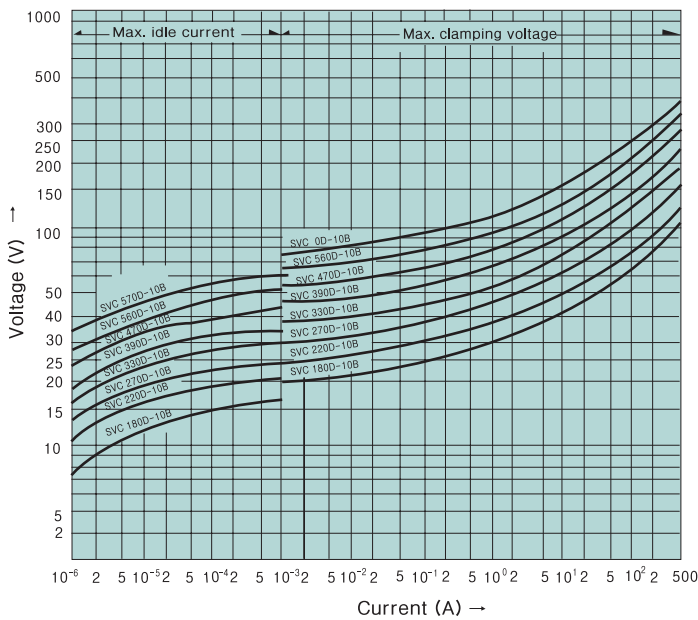

PULSE LIFETIME RATINGS

Notes : 2 - pulse : 5 - minute interval
3 to 10 - pulse : 2 - minute interval
Up to 10^6 - pulse : 10 - second interval

• 10B (SVC 180D-10B to SVC680D-10B)

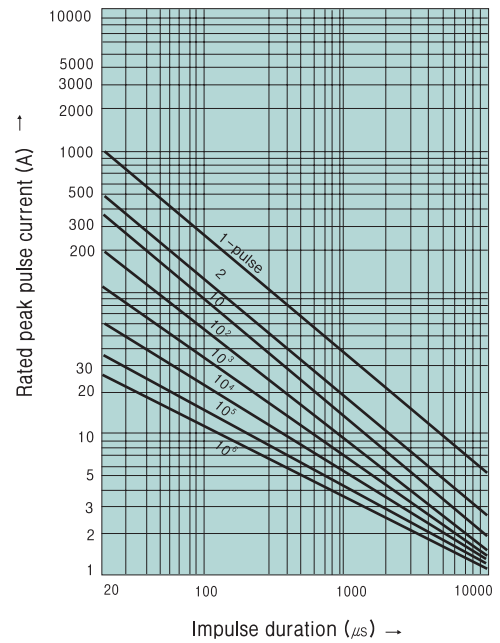

• 10A (SVC 820D-10A to SVC471D-10A)

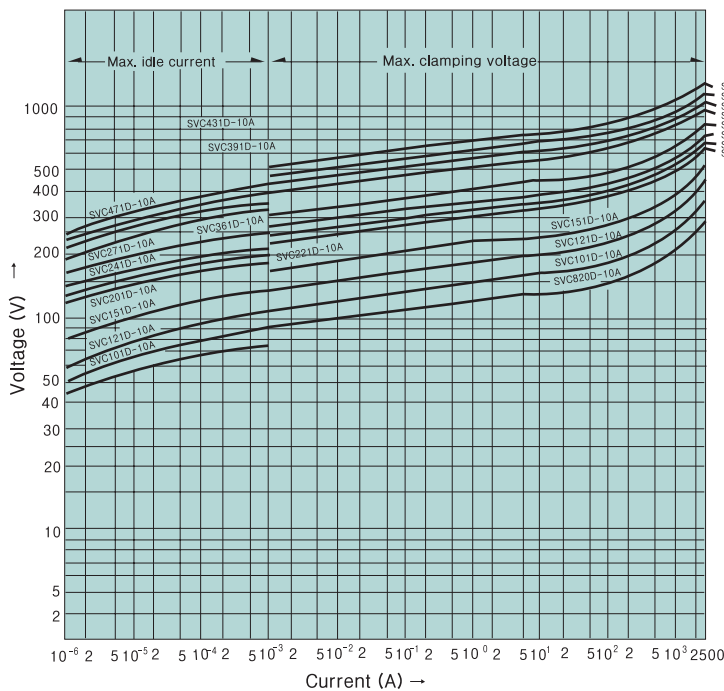

• 10A (SVC 820D-10A to SVC471D-10A)

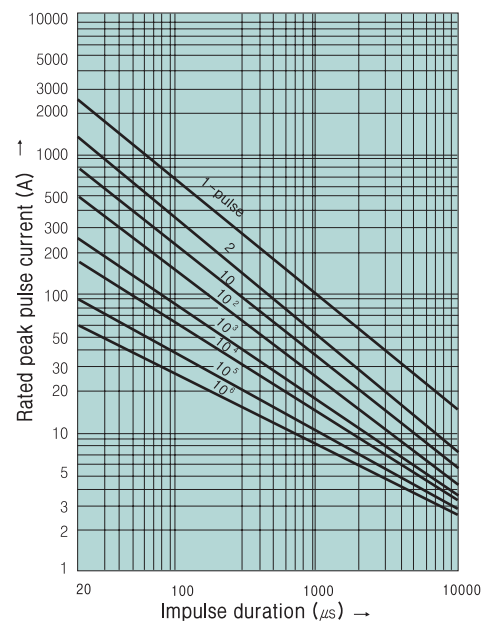

CERAMIC SURGE ABSORBERS (VARISTORS)

SVC

TRANSIENT V-I CHARACTERISTIC CURVES

Current waveform Under 10^{-2} A : DC
 Over 10^{-1} A : 8/20 μ s

• 10A (SVC561D-10A to SVC112D-10A)

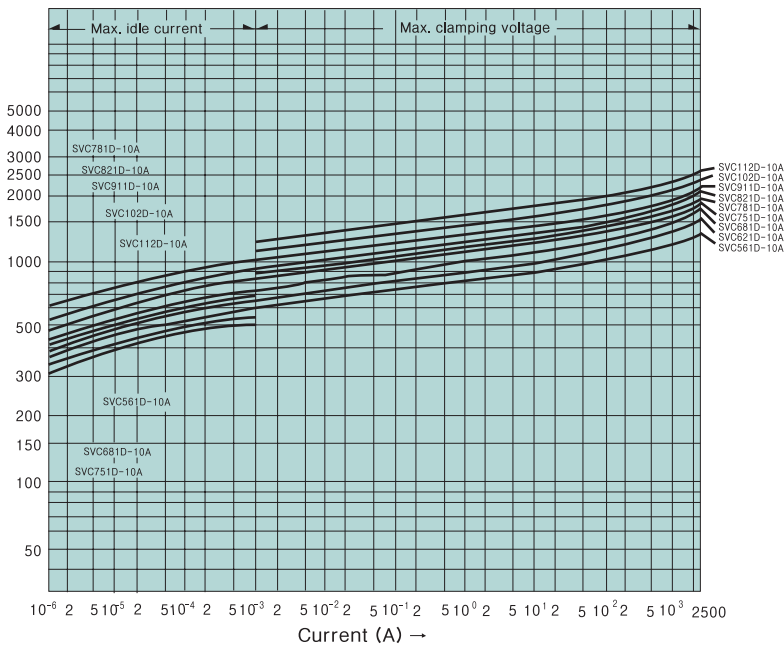

PULSE LIFETIME RATINGS

Notes : 2 - pulse : 5 - minute interval
 3 to 10 - pulse : 2 - minute interval
 Up to 10^6 - pulse : 10 - second interval

• 10A (SVC 561D-10A to SVC112D-10A)

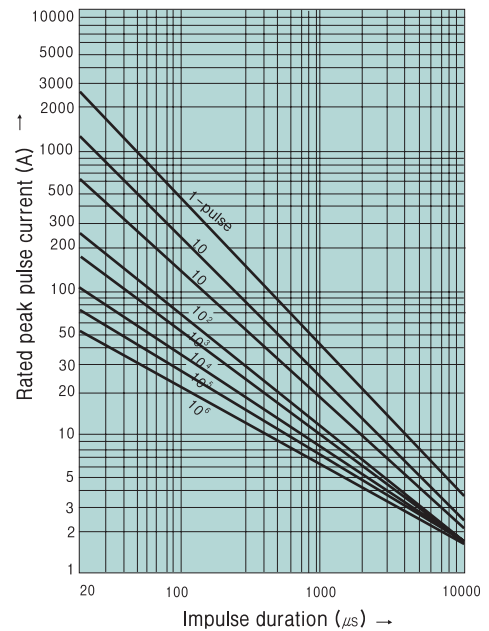

• 14B (SVC 180D-14B to ENC680D-14B)

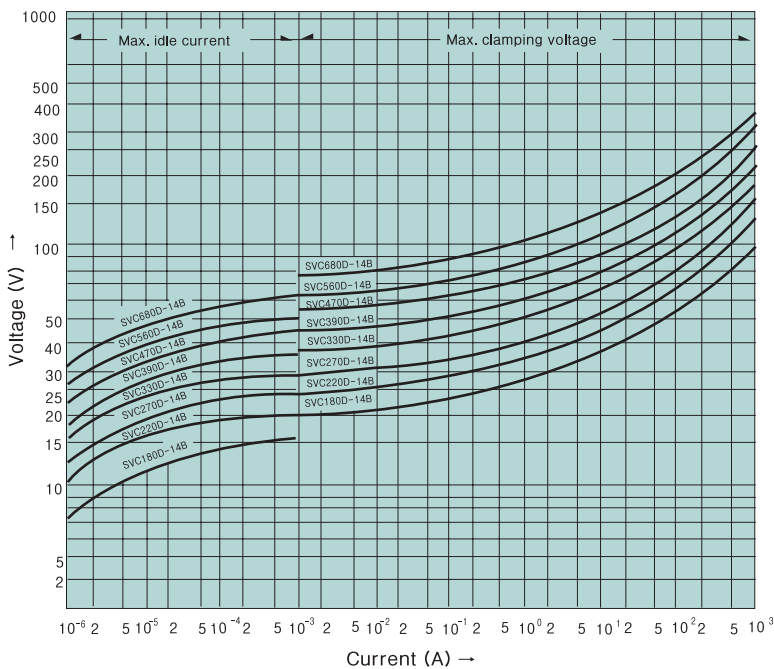

• 14B (SVC 180D-14B to SVC680D-14B)

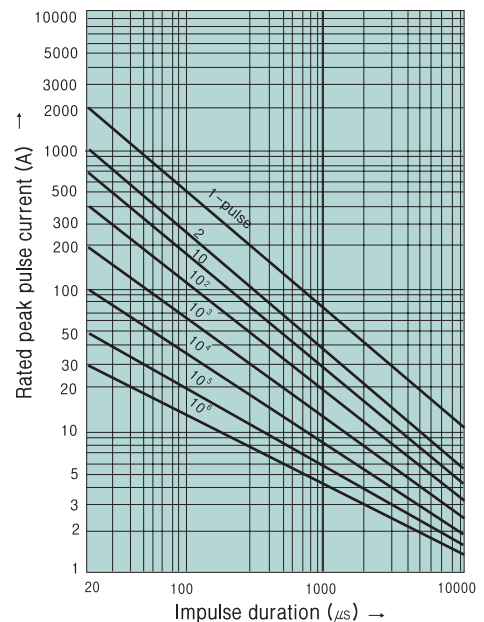

SVC

TRANSIENT V-I CHARACTERISTIC CURVES

Current waveform Under 10^{-2} A : DC
Over 10^{-1} A : 8/20 μ s

• 14A (SVC 820D-14A to SVC471D-14A)

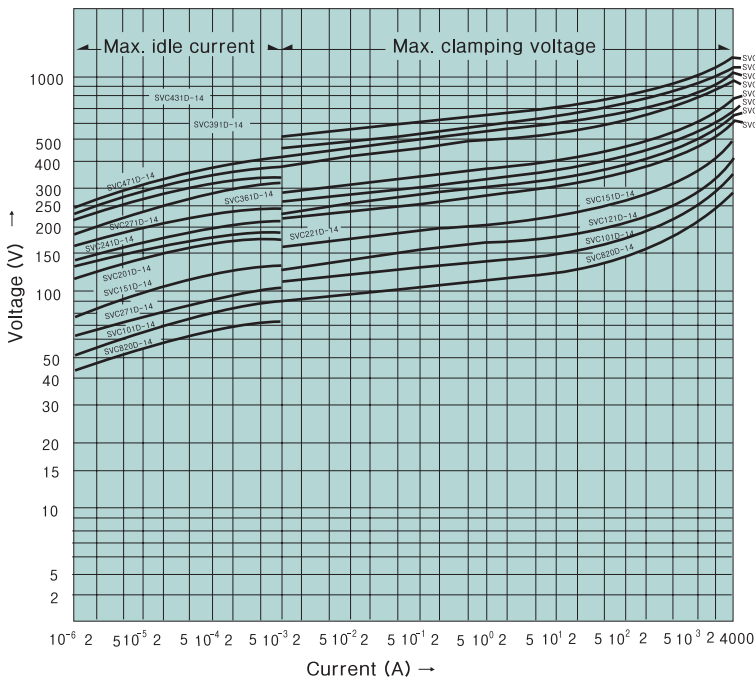

PULSE LIFETIME RATINGS

Notes : 2 - pulse : 5 - minute interval
3 to 10 - pulse : 2 - minute interval
Up to 10^6 - pulse : 10 - second interval

• 14A (SVC 820D-14A to SVC471D-14A)

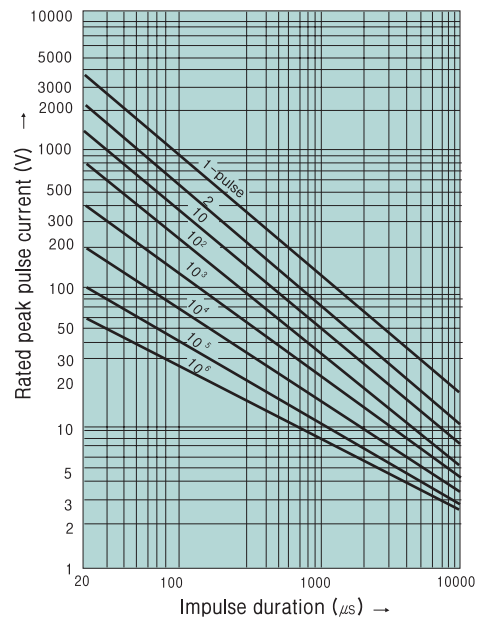

• 14A (SVC 561D-14A to SVC182D-14A)

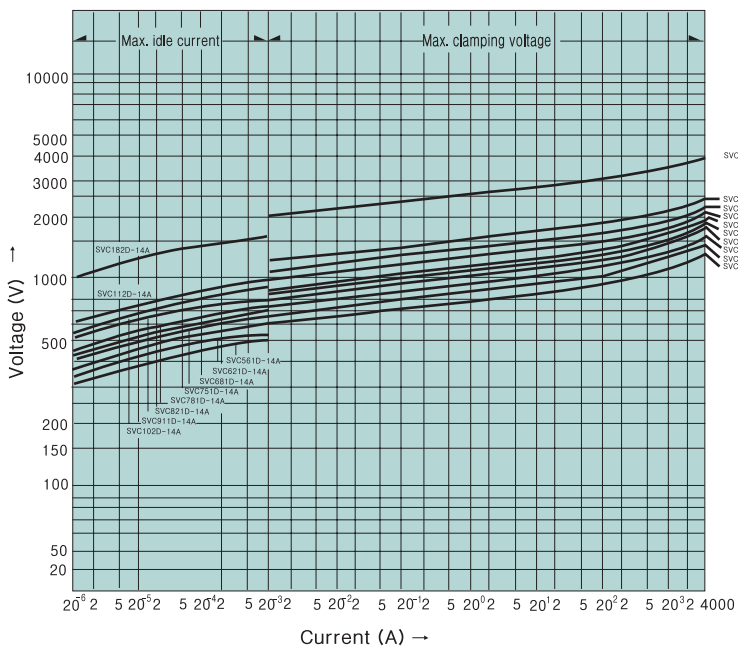

• 14A (SVC 561D-14A to SVC182D-14A)

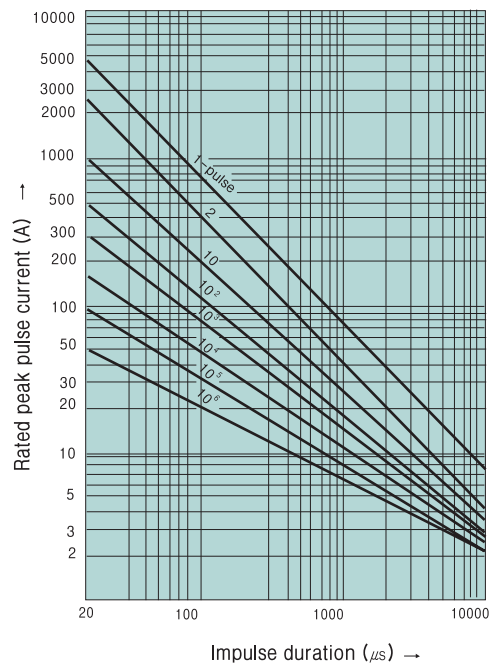

CERAMIC SURGE ABSORBERS (VARISTORS)

SVC

TRANSIENT V-I CHARACTERISTIC CURVES

Current waveform Under 10^{-2} A : DC
Over 10^{-1} A : 8/20 μ s

• 20B (SVC180D-20B to SVC680D-20B)

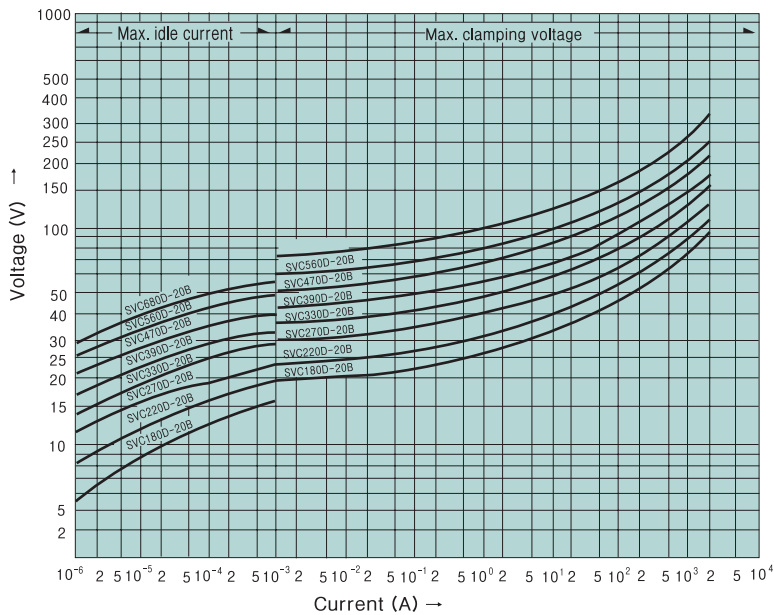

PULSE LIFETIME RATINGS

Notes : 2 - pulse : 5 - minute interval
3 to 10 - pulse : 2 - minute interval
Up to 10^6 - pulse : 10 - second interval

• 20B (SVC180D-20B to SVC680D-20B)

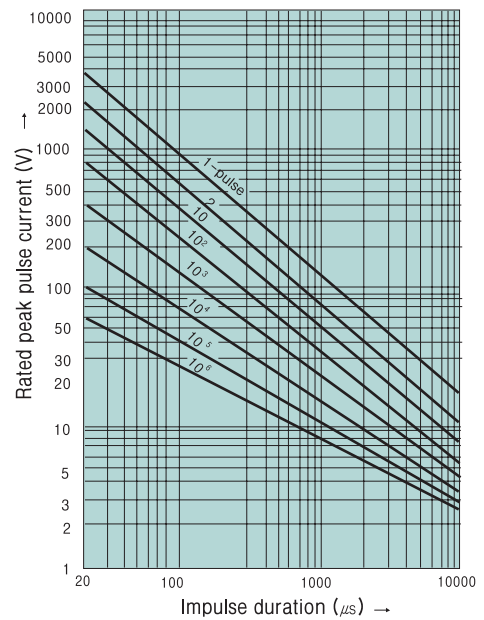

• 20A (SVC 820D-20A to SVC471D-20A)

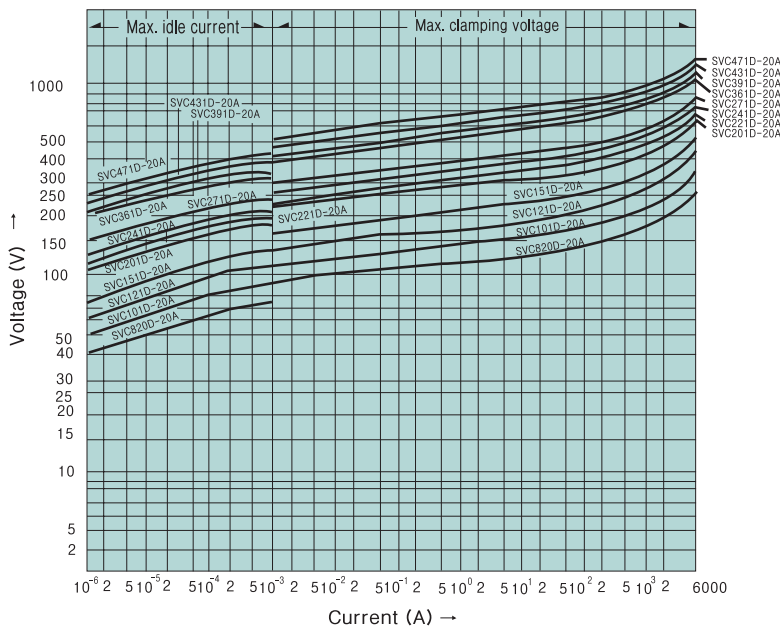

• 20A (SVC 820D-20A to SVC471D-20A)

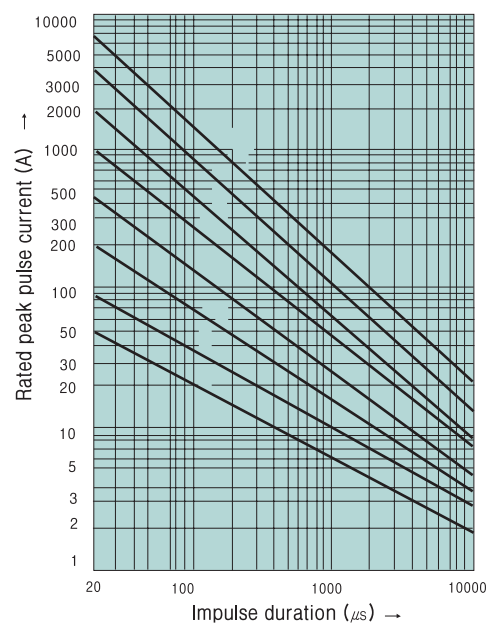

SVC

TRANSIENT V-I CHARACTERISTIC CURVES

Current waveform Under 10^{-2} A : DC
 Over 10^{-1} A : 8/20 μ s

• 20A (SVC 561D-20A to SVC182D-20A)

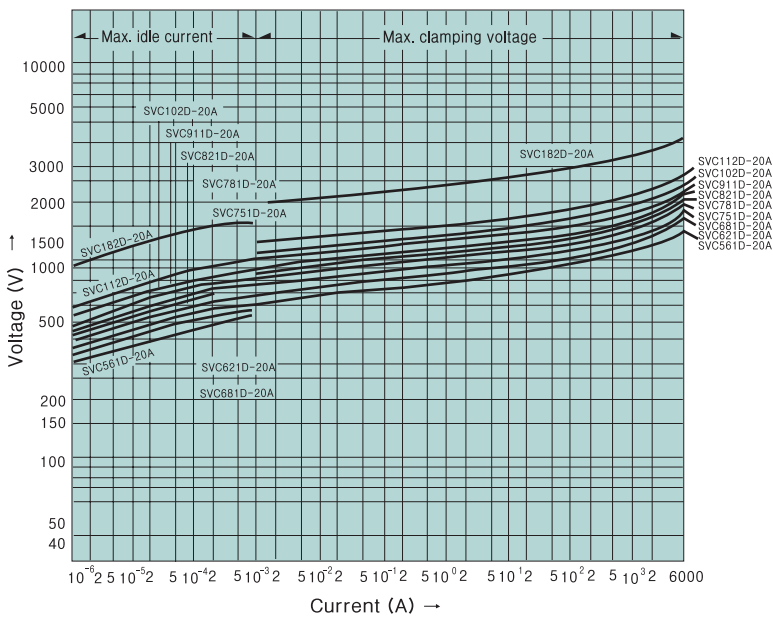

PULSE LIFETIME RATINGS

Notes : 2 - pulse : 5 - minute interval
 3 to 10 - pulse : 2 - minute interval
 Up to 10^6 - pulse : 10 - second interval

• 20A (SVC 561D-20A to SVC182D-20A)

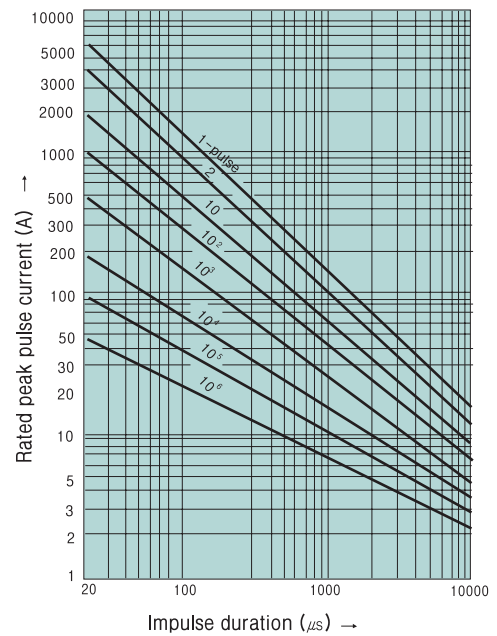

CERAMIC SURGE ABSORBERS (VARISTORS)

SVC

APPLICATIONS

- The protection of semiconducting elements such as diodes, thyristors, transistors, IC and relays against transient voltages.
- Similar protection of many types of measuring instruments, control machinery and communication equipment and broadcasting equipment against inductive lightning and switching surges.
- Protection of general purpose electrical equipment, domestic machinery and appliances, TV and radios and similar consumer products against lightning and switching surges.

Power supply circuit protection

Line circuit

Varistor voltage selection table (Z)

Power supply voltage	Type
100V AC	SVC201D-□□A SVC221D-□□A SVC241D-□□A SVC271D-□□A*
200V AC	SVC391D-□□A SVC431D-□□A SVC471D-□□A*
12V DC	SVC220D-□□B
24V DC	SVC390D-□□B

Notes :

- ①The power supply voltage must not exceed the maximum allowable circuit voltage.
- ②Since independent wiring loads and capacitive loads cause the voltage build-up at the time of opening or closing the load, use SVC having a varistor voltage as high as possible.(mark)
- ③The bold faced portions of the type letters vary.

AC/DC single-phase circuit

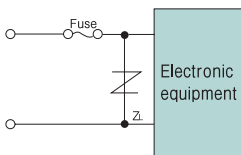

AC three-phase circuit

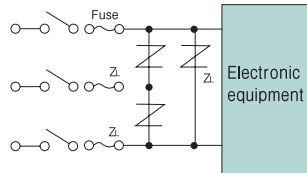

Line and ground circuit

Varistor voltage selection table (Zε)

Power supply voltage	Type
100V AC	SVC431D-□□A
200V AC	SVC471D-□□A SVC751D-□□A to SVC 112D-□□A* SVC182D-□□A**

Notes :

- ①When subjected to megger testing (500V DC), the insulation resistance value can decrease due to the leakage current of the SVC. To avoid this remove the varistor or use marked SVC.
 - ②When subjected to dielectric strength test(1000V AC). remove the SVC or use** marked SVC.
- Select varistors taking a note of operating conditions peculiar to the equipment.

AC/DC single-phase circuit

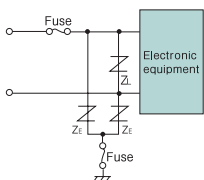

AC three-phase circuit

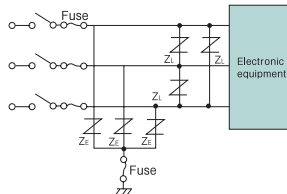

Telecommunication circuit protection

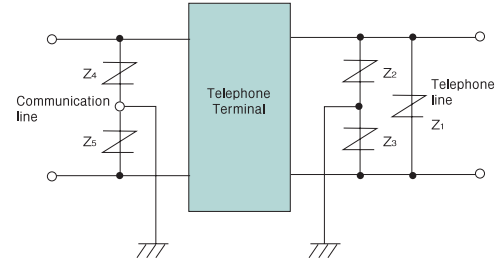

Varistor voltage selection guided

Power supply voltage	Type
12V DC	SVC180D-□□B SVC220D-□□B SVC820D-□□A
24V AC	SVC390D-□□B SVC820D-□□A

Notes :

The varistor SVC has a capacitance value. Take note of this when applying them to high-frequency signal circuits.

Switching circuit protection

Protection of relay (Contact coil)

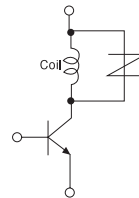

Protection of semiconductors

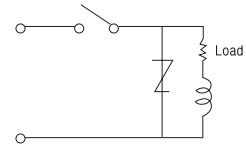
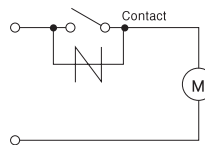
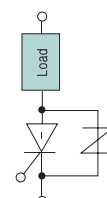

Varistor voltage selection guide

Power supply voltage	Type
12V DC	SVC220D-□□B
24V DC	SVC390D-□□B
100V DC	SVC151D-□□A
100V AC	SVC201D-□□A SVC221D-□□A SVC241D-□□A SVC271D-□□A

Notes :

- ①The power supply voltage must not exceed the maximum allowable circuit voltage of the SVC
- ②Pay due attention to the surge energy generated by the load.
- ③Select SVC referring to the pulse lifetime rating.
- ④To further reduce the tendency of sparking across the contacts connect a capacitor parallel with the SVC. This will also protect the equipment from electromagnetic wave jamming.

CERAMIC SURGE ABSORBERS (VARISTORS)

SVC

Application notes

1. Overcurrent protection

When surges exceed the rating for the SVC, short-circuits or damages can be expected. Take following precautions.

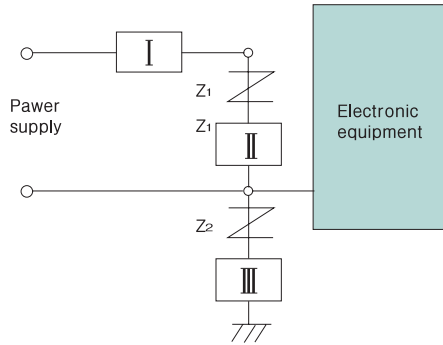

① Connect the SVC at a position nearer to the equipment than the overcurrent protection device “I” (fuse, MCCB) as is shown in the diagram.

When the SVC is shorted, the overcurrent protection device “I” operates (trips or blow off the fuse).

② If the overcurrent protection device “I” can not be installed in “I” position, connect a fuse at “II” position. Select fuse rated current for the SVC referring to the following table .

SVC	05A 05B	07A 07B	10A 10B	14A 14B	20A 20B
Applicable fuse rated current(A)	1 to 2	2 to 3	3 to 5	3 to 10	5 to 15

③ When “Z₂” SVC is connected between the equipment and ground install an ELCB (Earth Leakage Circuit Breaker). If not possible, connect a fuse or thermal fuse at “III” position.

2. Installation

① When operated at location near heating element or exposed to direct sun light, confirm that the the ambient temperature range.

② When operated in dusty or dirty locations, or exposed to corrosive atmospheres, or where metallic powders or salt can be expected, be sure to mount within a protective enclosure.

3. Molding

When shielding the SVC in a resin molding, take a note of the materials used and temperature, since they influence the reliability. For further information please contact SAMWHA

4. Current, power and energy rating vs, temperature

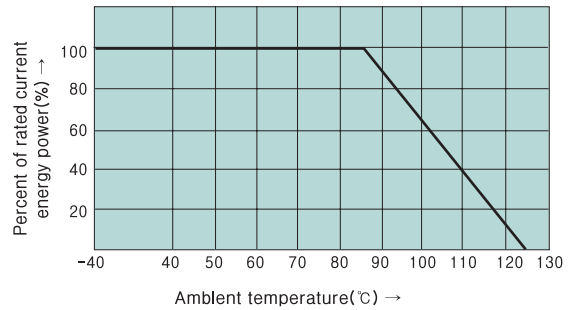

5. Electrical Characteristics

Operating ambient temperature	-40°C to + 85°C
Storage temperature	-40°C to + 125°C
Voltage temperature coefficient	-0.05%/°C
Insulation resistance(at500V)	Over 1000MΩ

Recognized standards

Standard	Date	Content	Applicable SVC series	File No.		
UL	UL 1449	Transient Voltage surge suppressors	Cord connected and Direct Plug in Type Equipment	05Series 07Series 10Series 14Series 20Series	E151195	
			Permanently connected type equipment	10Series 14Series 20Series		
	UL 1414	88.05.10	Across-The-Line Components	125V AC	SVC 201D - □A ~SVC 391D - □A	E97754
250V AC	SVC 391D - □A ~SVC 182D - □A					
UL 497B	93.07.06	Protectors for data communication and fire alarm circuit	SVC 180D - □~SVC 821D - □		E154171	
CAS	C22.2 NO.1-M 1981	93.07.27	Varistor for Across -The-Line use as transient protection on 120Vac system	125V AC	SVC 201D - □A ~SVC 182D - □A	LR78923
ISO 9002	94.12.15				KRQ-007/94	

SVC

APPLICATION EXAMPEL

Fire alarm system

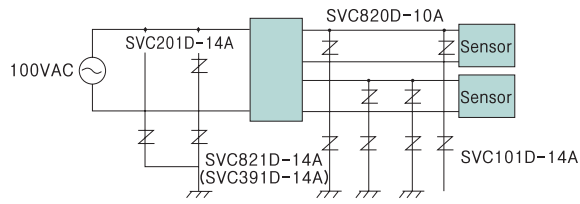

Stove, Boiler

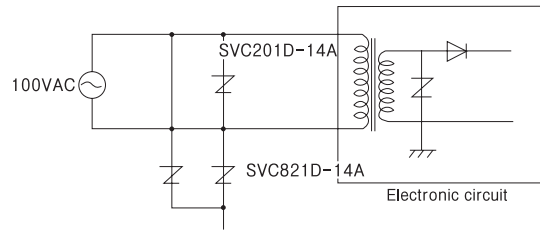

Traffic signal control

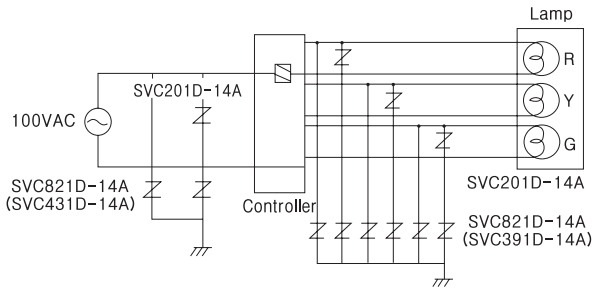

Vending machine

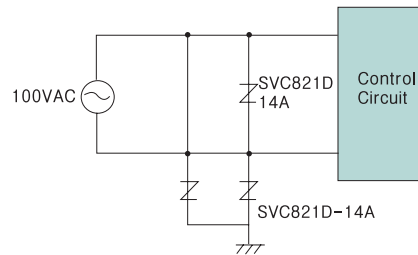

Solenoid

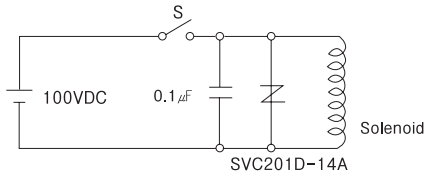

Brake, Clutch

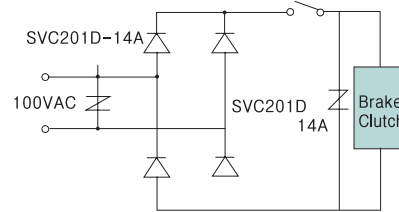

Contact protection

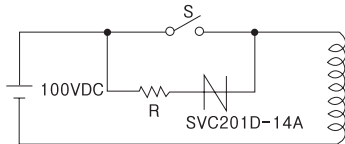

Microwave oven

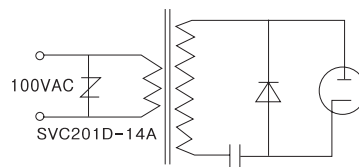

Thyristor protection

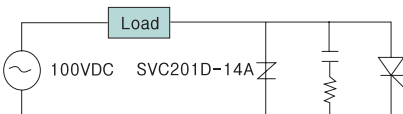

Triac protection

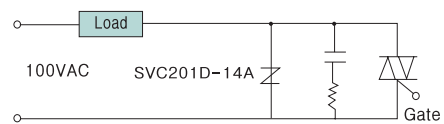

TV booster

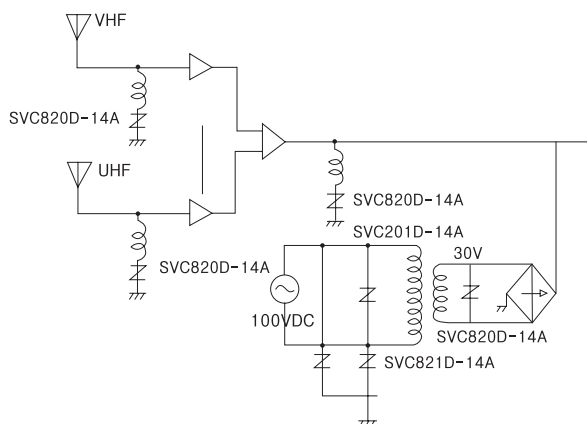

Sound output circuit

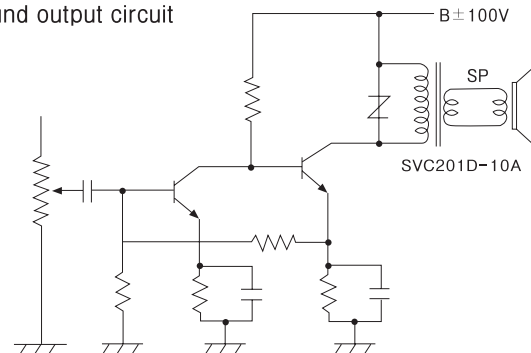

SVC

Varistor Terminology

• **Varistor Voltage : V_{nom}**

Varistor peak terminal voltage measured with a specified current applied
The DC current applied is 1mA normally.

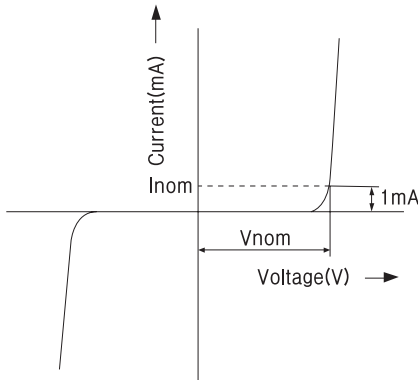

• **Clamping voltage : V_c**

Maximum terminal voltage (peak voltage across the varistor) measured with an applied 8/20 μ s impulse of a given peak current.

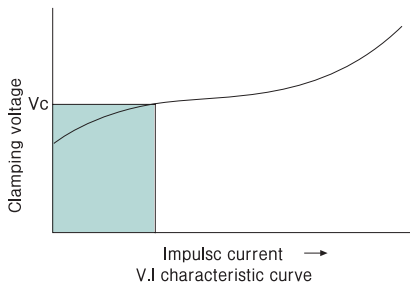

• **Capacitance**

Typical values measured at a test frequency of 1kHz

• **Rated peak transient current : i_{tm}**

Maximum peak current through the varistor with line voltage applied.
The maximum peak current with in the varistor voltage change ratio of $\pm 10\%$ with the standard 8/20 μ s impulse current applied two times at 5 minute interval.

• **Rated transient energy : W_{tm}**

Maximum allowable energy for a single impulse of 2ms square-wave current waveform with rated continuous voltage applied. Maximum energy rating base on a shift of V_{nom} of less than $\pm 10\%$ of initial value.

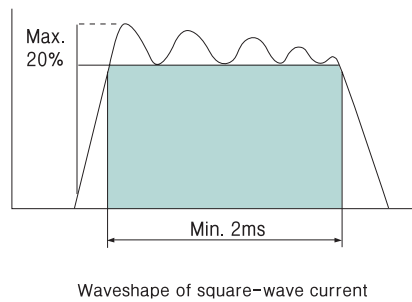

• **Pulse lifetime rating**

This is expressed as the maximum allowable number of impulse currents applied.
8/20 μ s impulse current (or 2ms square wave) is applied at prescribed interval.
This curve also provides for derating current as required with repetitive pulsing.

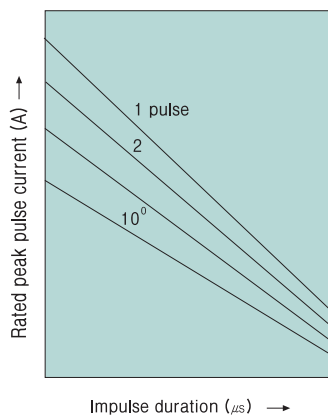

• **Tset current waveform**

Characteristics tests for Varistors are carried out by using 8/20 μ s test impulses. Data such as the maximum clamping voltage (V_c) and the transient peak current (i_{tm}) are obtained by using this impulse current.

However, for the V_c characteristics of the Axial package type a 10mA DC squarewave current is used to carry out the test.

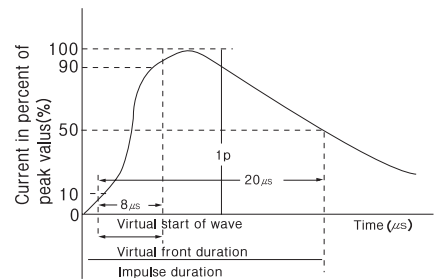

• **Rated RMS Voltage : V_{acm}**

Maximum continuous sinusoidal RMS voltage at 50/60Hz which may be applied.

• **Rated DC Voltage : V_{dcm}**

Maximum continuous DC voltage which may be applied.

• **Rated average power dissipation : P_{tam}**

Maximum average power that can be applied within the specified ambient temperature.