

Bias Resistor Transistors

NPN Silicon Surface Mount Transistor with Monolithic Bias Resistor Network

This new series of digital transistors is designed to replace a single device and its external resistor bias network. The BRT (Bias Resistor Transistor) contains a single transistor with a monolithic bias network consisting of two resistors; a series base resistor and a base-emitter resistor. The BRT eliminates these individual components by integrating them into a single device. The use of a BRT can reduce both system cost and board space. The device is housed in the SC-70 / SOT-323 package which is designed for low power surface mount applications.

- Simplifies Circuit Design
- Reduces Board Space
- Reduces Component Count

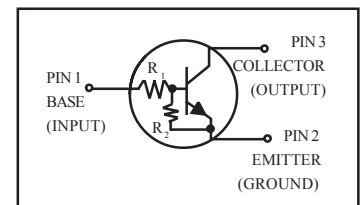
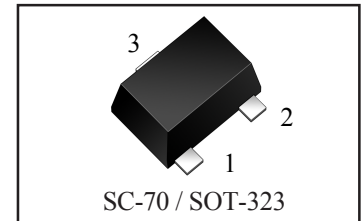

DEVICE MARKING INFORMATION

See specific marking information in the device marking table on page 2 of this data sheet.

MAXIMUM RATINGS (T_A = 25 °C unless otherwise noted)

Rating	Symbol	Value	Unit
Collector-Base Voltage	V _{CBO}	50	Vdc
Collector-Emitter Voltage	V _{CEO}	50	Vdc
Collector Current	I _C	100	mAdc

THERMAL CHARACTERISTICS

Characteristic	Symbol	Max	Unit
Total Device Dissipation T _A = 25 °C Derate above 25 °C	P _D	202 (Note 1.) 310 (Note 2.) 1.6 (Note 1.) 2.5 (Note 2.)	mW mW/ °C
Thermal Resistance – Junction-to-Ambient	R _{θJA}	618 (Note 1.) 403 (Note 2.)	C/W
Thermal Resistance – Junction-to-Lead	R _{θJL}	280 (Note 1.) 332 (Note 2.)	C/W
Junction and Storage Temperature Range	T _J , T _{stg}	-55 to +150	°C

1. FR-4 @ Minimum Pad
2. FR-4 @ 1.0 x 1.0 inch Pad



DEVICE MARKING RESISTOR VALUES AND ORDERING INFORMATION

Device	Package	Marking	R1 (K)	R2 (K)	Shipping
DTC301T1G (Note 3) DTC301T3G	SC-70 / SOT-323	8J	4.7	4.7	3000/Tape & Reel 10,000/Tape & Reel
DTC302T1G DTC302T3G	SC-70 / SOT-323	8A	10	10	3000/Tape & Reel 10,000/Tape & Reel
DTC303T1G DTC303T3G	SC-70 / SOT-323	8B	22	22	3000/Tape & Reel 10,000/Tape & Reel
DTC304T1G DTC304T3G	SC-70 / SOT-323	8C	47	47	3000/Tape & Reel 10,000/Tape & Reel
DTC305T1G (Note 3) DTC305T3G	SC-70 / SOT-323	8M	2.2	47	3000/Tape & Reel 10,000/Tape & Reel
DTC306T1G (Note 3) DTC306T3G	SC-70 / SOT-323	8K	4.7	47	3000/Tape & Reel 10,000/Tape & Reel
DTC307T1G DTC307T3G	SC-70 / SOT-323	8D	10	47	3000/Tape & Reel 10,000/Tape & Reel
DTC308T1G (Note 3) DTC308T3G	SC-70 / SOT-323	8L	22	47	3000/Tape & Reel 10,000/Tape & Reel
DTC309T1G (Note 3) DTC309T3G	SC-70 / SOT-323	8P	47	22	3000/Tape & Reel 10,000/Tape & Reel
DTC310T1G (Note 3) DTC310T3G	SC-70 / SOT-323	8F	4.7	∞	3000/Tape & Reel 10,000/Tape & Reel
DTC311T1G (Note 3) DTC311T3G	SC-70 / SOT-323	8E	10	∞	3000/Tape & Reel 10,000/Tape & Reel
DTC317T1G (Note 3) DTC317T3G	SC-70 / SOT-323	8H	2.2	2.2	3000/Tape & Reel 10,000/Tape & Reel
DTC322T1G (Note 3) DTC322T3G	SC-70 / SOT-323	8N	100	100	3000/Tape & Reel 10,000/Tape & Reel
DTC323T1G (Note 3) DTC323T3G	SC-70 / SOT-323	8G	1	1	3000/Tape & Reel 10,000/Tape & Reel

3. New devices. Updated curves to follow in subsequent data sheets.



DTC301~DTC311 / DTC317 / DTC322~DTC323

ELECTRICAL CHARACTERISTICS (T_A = 25 C unless otherwise noted)

Characteristic	Symbol	Min	Typ	Max	Unit
OFF CHARACTERISTICS					
Collector-Base Cutoff Current (V _{CB} = 50 V, I _E = 0)	I _{CBO}	–	–	100	nAdc
Collector-Emitter Cutoff Current (V _{CE} = 50 V, I _B = 0)	I _{CEO}	–	–	500	nAdc
Emitter-Base Cutoff Current (V _{EB} = 6.0 V, I _C = 0)	I _{EBO}	–	–	1.5	mAdc
DTC301		–	–	0.5	
DTC302		–	–	0.2	
DTC303		–	–	0.1	
DTC304		–	–	0.2	
DTC305		–	–	0.18	
DTC306		–	–	0.2	
DTC307		–	–	0.13	
DTC308		–	–	0.13	
DTC309		–	–	1.9	
DTC310		–	–	0.9	
DTC311		–	–	2.3	
DTC317		–	–	0.05	
DTC322		–	–	4.3	
DTC323		–	–		
Collector-Base Breakdown Voltage (I _C = 10μA, I _E = 0)	V _{(BR)CBO}	50	–	–	Vdc
Collector-Emitter Breakdown Voltage (Note 4.) (I _C = 2.0 mA, I = 0)	V _{(BR)CEO}	50	–	–	Vdc
ON CHARACTERISTICS (Note 4.)					
DC Current Gain (V _{CE} = 10 V, I _C = 5.0 mA)	h _{FE}	15	30	–	
DTC301		35	60	–	
DTC302		60	100	–	
DTC303		80	140	–	
DTC304		80	140	–	
DTC305		80	200	–	
DTC306		80	140	–	
DTC307		80	150	–	
DTC308		80	140	–	
DTC309		160	350	–	
DTC310		160	350	–	
DTC311		8.0	15	–	
DTC317		80	150	–	
DTC322		3.0	5.0	–	
DTC323					
Collector-Emitter Saturation Voltage (I _C = 10 mA, I _B = 0.3 mA) (I _C = 10 mA, I _B = 5 mA) (I _C = 10 mA, I _B = 1 mA)	V _{CE(sat)}	–	–	0.25	Vdc
DTC317 / DTC323					
DTC301 / DTC306 / DTC308					
DTC310 / DTC311					
Output Voltage (on) (V _{CC} = 5.0 V, V _B = 2.5 V, R _L = 1.0 kΩ)	V _{OL}	–	–	0.2	Vdc
DTC301		–	–	0.2	
DTC302		–	–	0.2	
DTC303		–	–	0.2	
DTC305		–	–	0.2	
DTC306		–	–	0.2	
DTC307		–	–	0.2	
DTC308		–	–	0.2	
DTC310		–	–	0.2	
DTC311		–	–	0.2	
DTC317		–	–	0.2	
DTC322		–	–	0.2	
(V _{CC} = 5.0 V, V _B = 3.5 V, R _L = 1.0 kΩ)		–	–	0.2	
(V _{CC} = 5.0 V, V _B = 4.0 V, R _L = 1.0 kΩ)		–	–	0.2	
(V _{CC} = 5.0 V, V _B = 5.5 V, R _L = 1.0 kΩ)		–	–	0.2	

4. Pulse Test: Pulse Width < 300μs, Duty Cycle < 2.0%



DTC301~DTC311 / DTC317 / DTC322~DTC323

ELECTRICAL CHARACTERISTICS (T_A = 25°C unless otherwise noted) (Continued)

Characteristic	Symbol	Min	Typ	Max	Unit
ON CHARACTERISTICS (Note 5.) (Continued)					
Output Voltage (off) (V _{CC} = 5.0 V, V _B = 0.5 V, R _L = 1.0 kΩ) (V _{CC} = 5.0 V, V _B = 0.25 V, R _L = 1.0 kΩ) (V _{CC} = 5.0 V, V _B = 0.050 V, R _L = 1.0 kΩ)	V _{OH}	4.9	–	–	Vdc
Input Resistor	R ₁	3.3	4.7	6.1	kΩ
		7.0	10	13	
		15.4	22	28.6	
		32.9	47	61.1	
		1.54	2.2	2.86	
		3.3	4.7	6.1	
		7.0	10	13	
		15.4	22	28.6	
		32.9	47	61.1	
		3.3	4.7	6.1	
		7.0	10	13	
		1.5	2.2	2.9	
		70	100	130	
		0.7	1.0	1.3	
Resistor Ratio	R ₁ /R ₂	0.8	1.0	1.2	
		0.8	1.0	1.2	
		0.038	0.047	0.056	
		0.055	0.1	0.185	
		0.17	0.21	0.25	
		0.38	0.47	0.56	
		1.7	2.1	2.6	
		–	–	–	

5. Pulse Test: Pulse Width < 300μs, Duty Cycle < 2.0%

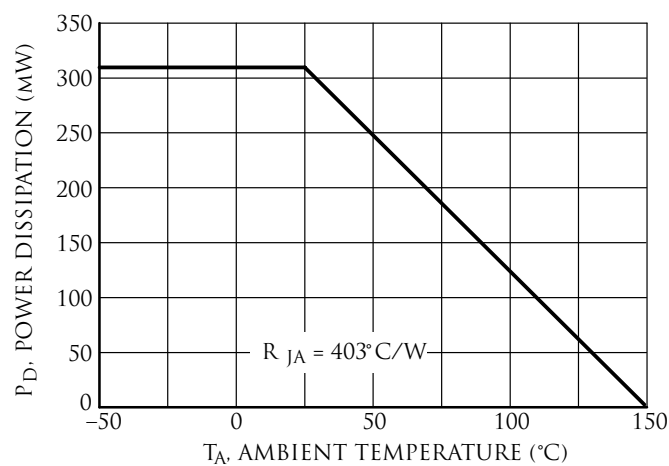

FIGURE 1. DERATING CURVE



TYPICAL ELECTRICAL CHARACTERISTICS – DTC302

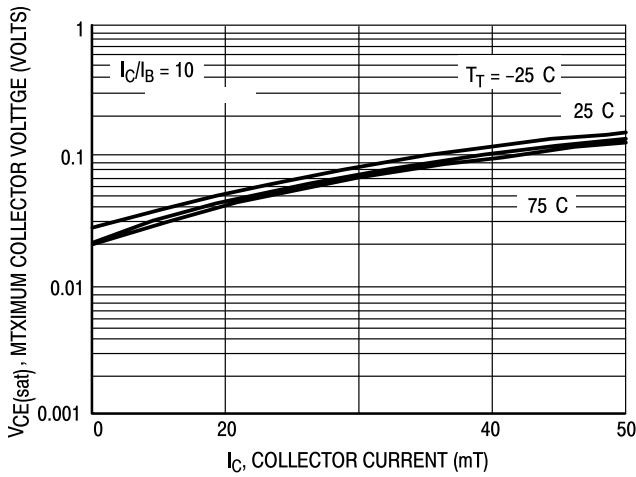

Figure 2. $V_{CE(sat)}$ versus I_C

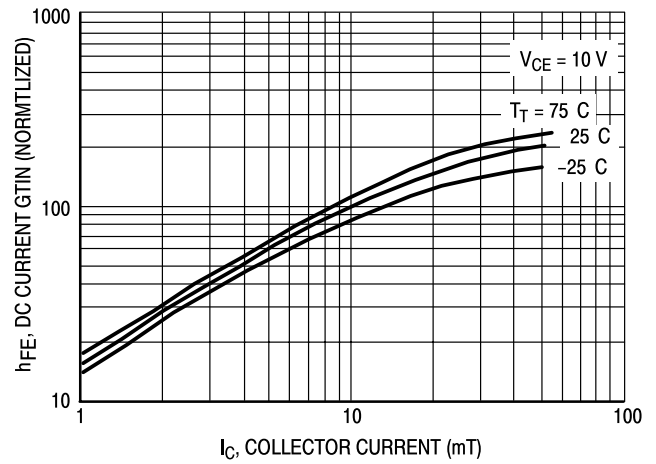

Figure 3. DC Current Gain

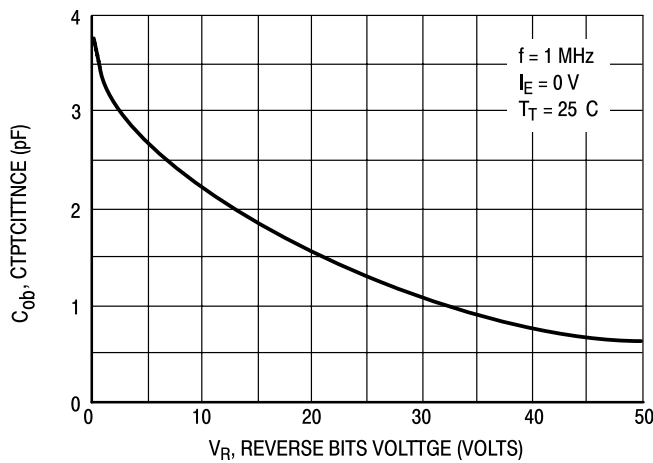

Figure 4. Output Capacitance

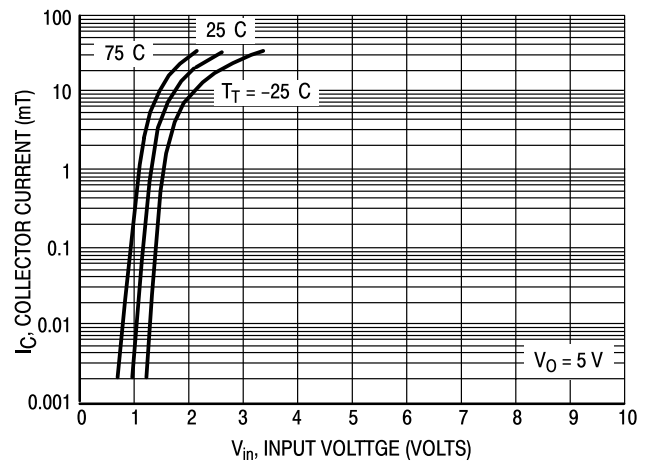

Figure 5. Output Current versus Input Voltage

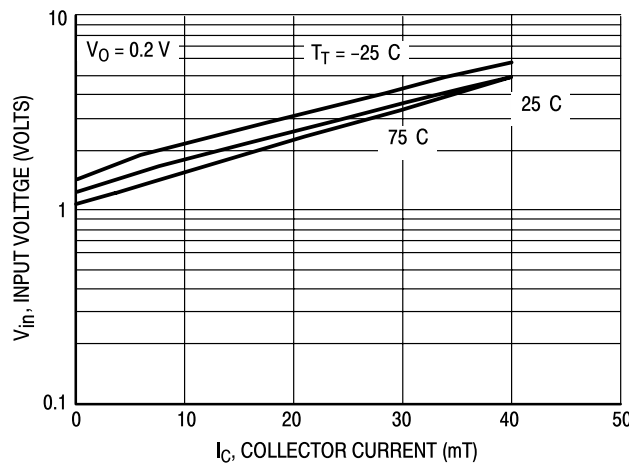

Figure 6. Input Voltage versus Output Current



TYPICAL ELECTRICAL CHARACTERISTICS – DTC303

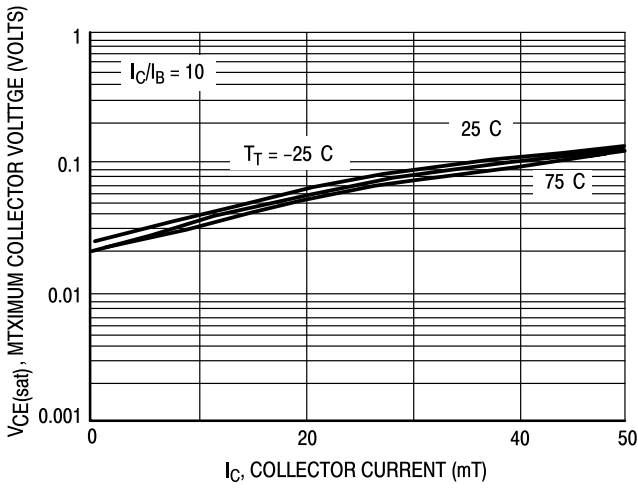

Figure 7. $V_{CE(sat)}$ versus I_C

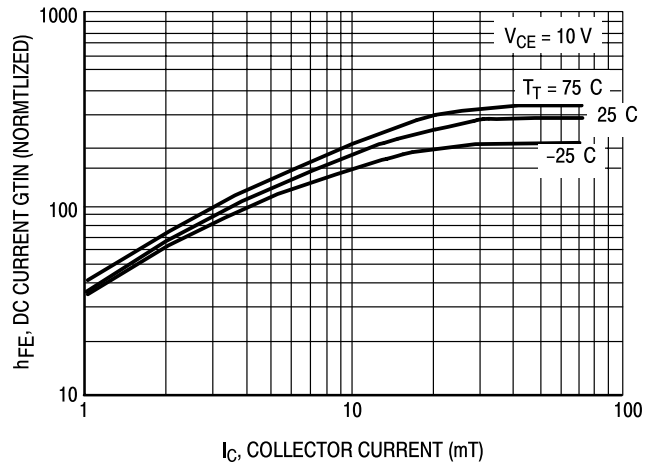

Figure 8. DC Current Gain

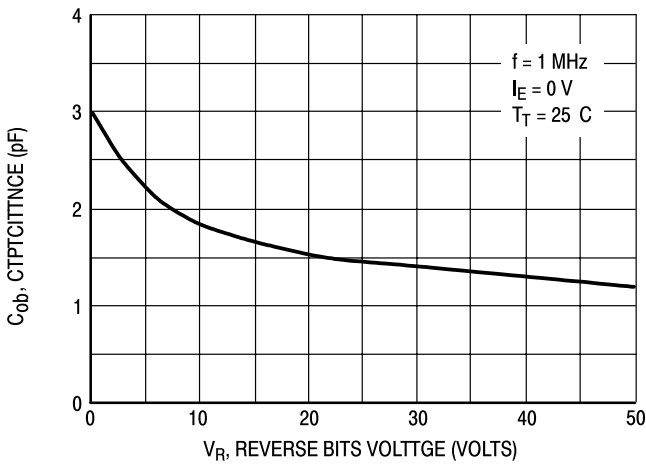

Figure 9. Output Capacitance

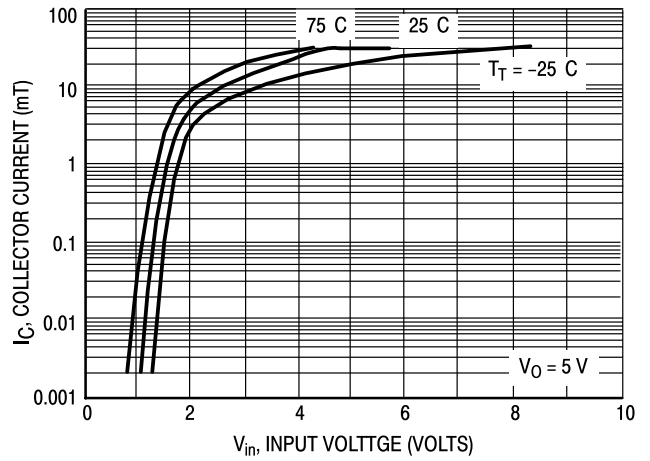

Figure 10. Output Current versus Input Voltage

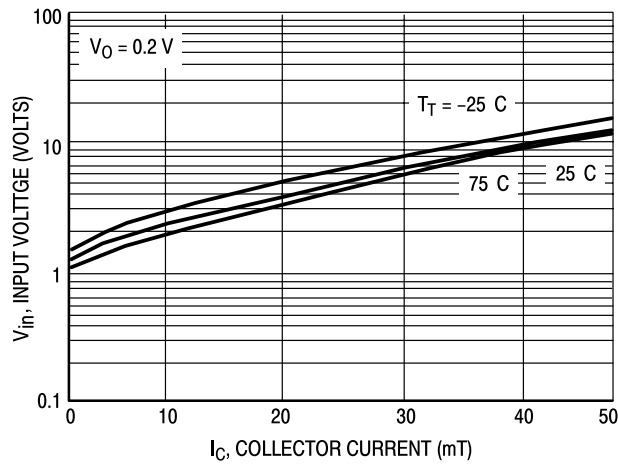

Figure 11. Input Voltage versus Output Current



TYPICAL ELECTRICAL CHARACTERISTICS – DTC304

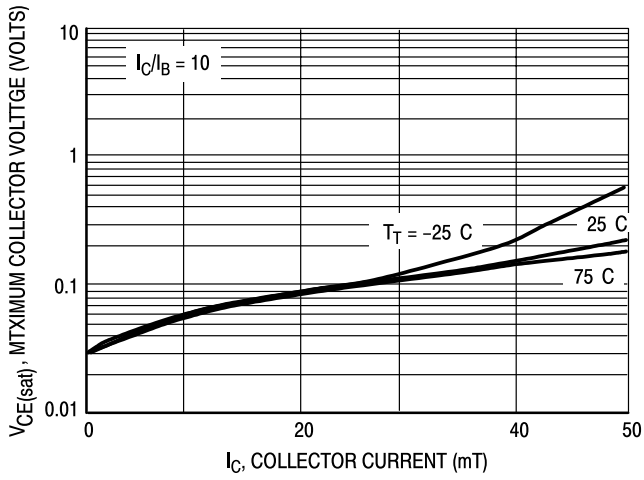

Figure 12. $V_{CE(sat)}$ versus I_C

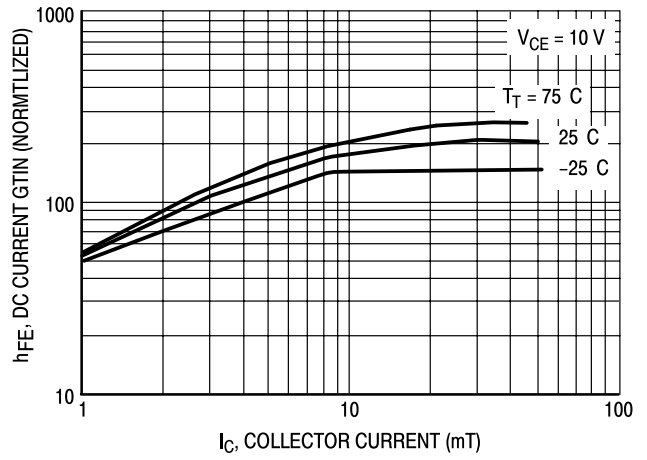

Figure 13. DC Current Gain

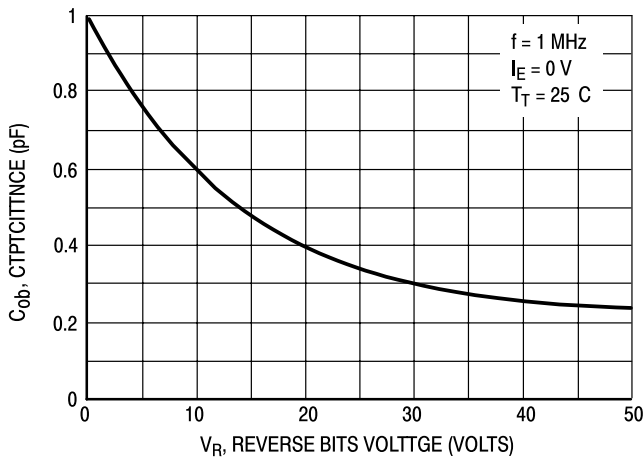

Figure 14. Output Capacitance

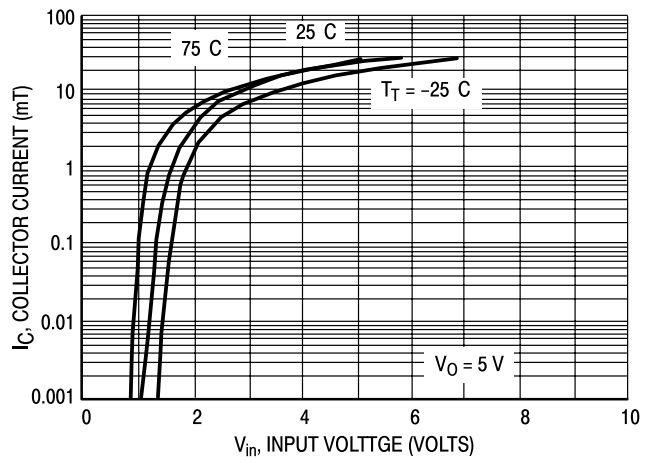

Figure 15. Output Current versus Input Voltage

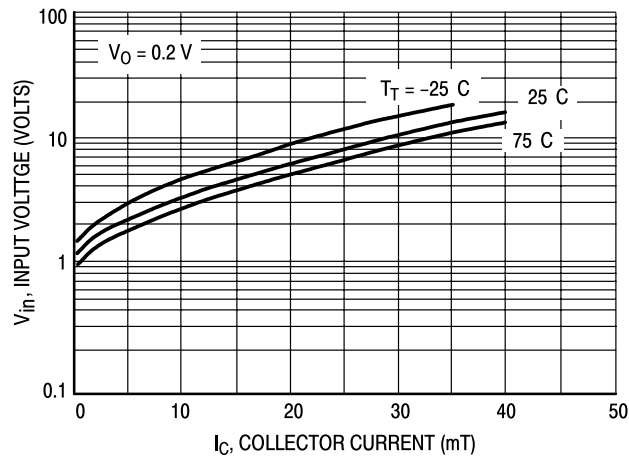

Figure 16. Input Voltage versus Output Current



TYPICAL ELECTRICAL CHARACTERISTICS – DTC307

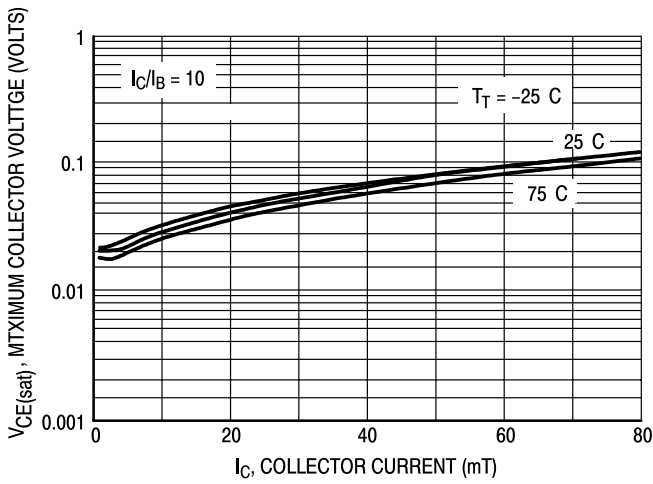

Figure 17. $V_{CE(sat)}$ versus I_C

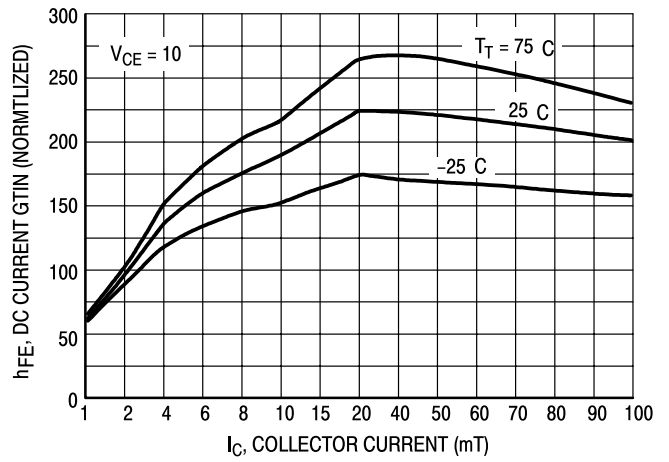

Figure 18. DC Current Gain

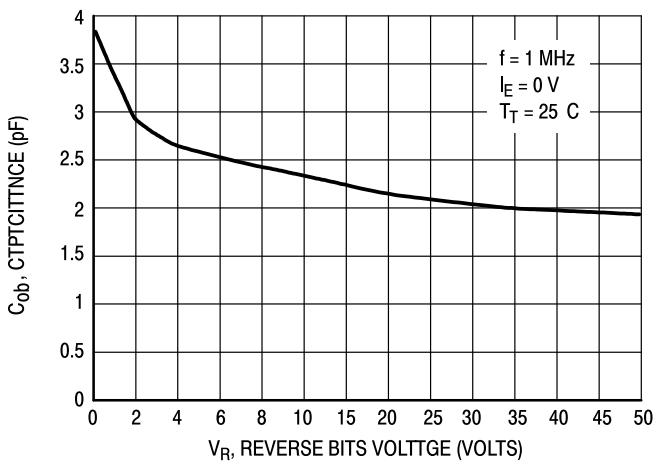

Figure 19. Output Capacitance

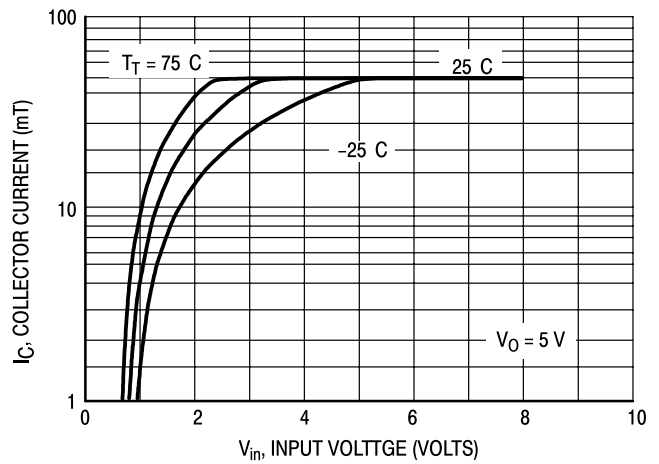

Figure 20. Output Current versus Input Voltage

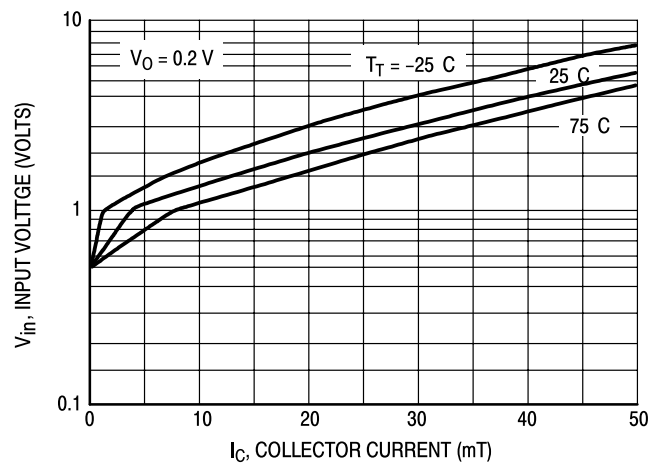

Figure 21. Input Voltage versus Output Current

TYPICAL APPLICATIONS FOR NPN BRTs

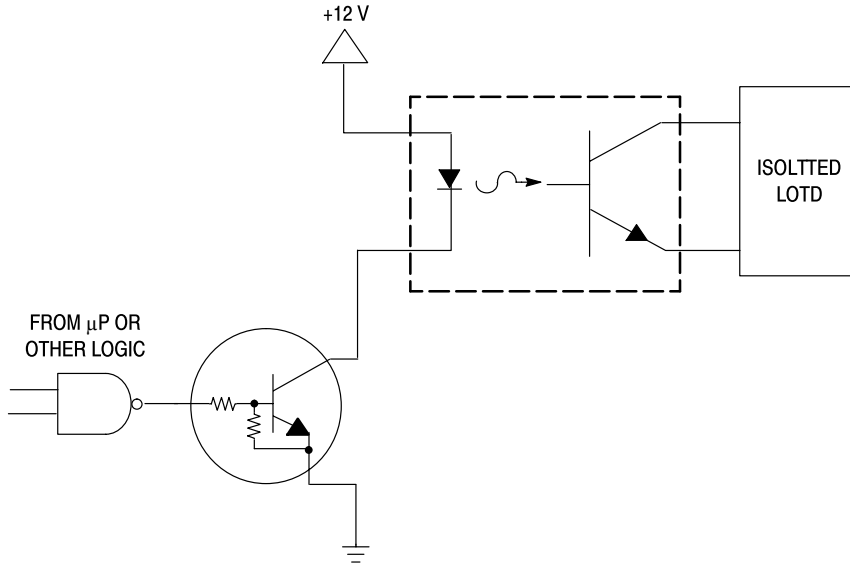

Figure 22. Level Shifter: Connects 12 or 24 Volt Circuits to Logic

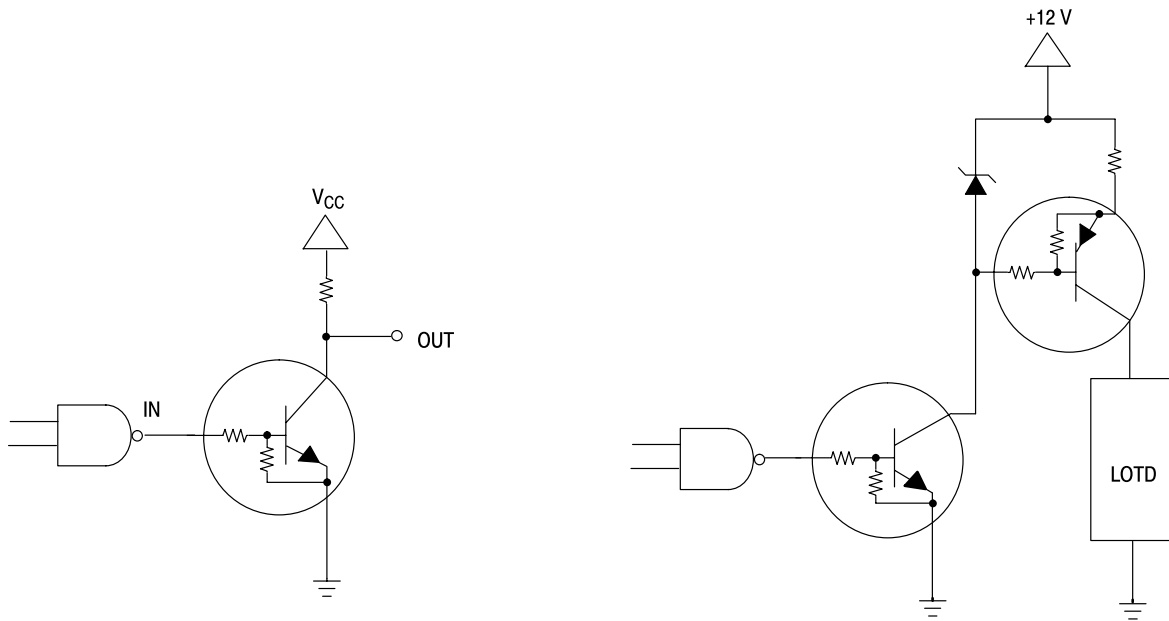

Figure 23. Open Collector Inverter: Inverts the Input Signal

Figure 24. Inexpensive, Unregulated Current Source

SC -70 / SOT -323

NOTES:

1. DIMENSIONING AND TOLERANCING PER ANSI Y14.5M, 1982.
2. CONTROLLING DIMENSION: INCH.

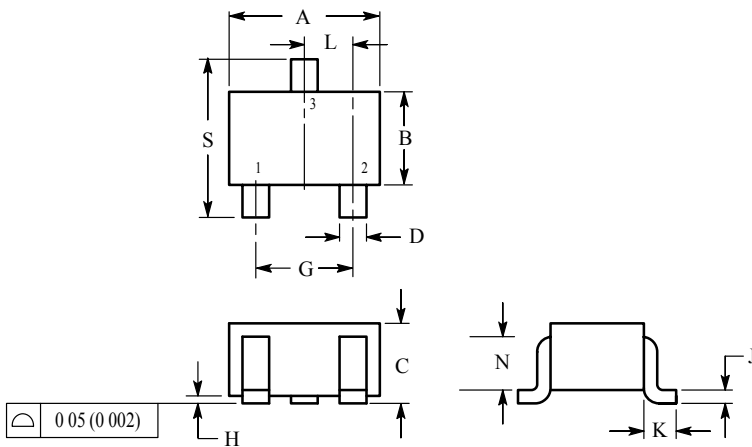

DIM	INCHES		MILLIMETERS	
	MIN	MAX	MIN	MAX
A	0.071	0.087	1.80	2.20
B	0.045	0.053	1.15	1.35
C	0.032	0.040	0.80	1.00
D	0.012	0.016	0.30	0.40
G	0.047	0.055	1.20	1.40
H	0.000	0.004	0.00	0.10
J	0.004	0.010	0.10	0.25
K	0.017 REF		0.425 REF	
L	0.026 BSC		0.650 BSC	
N	0.028 REF		0.700 REF	
S	0.079	0.095	2.00	2.40

- PIN 1. BASE
 2. EMITTER
 3. COLLECTOR

