

### Bias Resistor Transistor NPN Silicon

 Lead(Pb)-Free

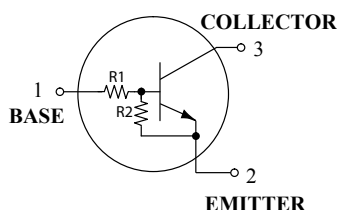

**SC-89**  
**(SOT-523F)**

### Maximum Ratings (T<sub>A</sub>=25°C unless otherwise noted)

Rating	Symbol	Value	Unit
Collector-Emitter Voltage	V <sub>CEO</sub>	50	V
Collector-Base Voltage	V <sub>CBO</sub>	50	V
Collector Current-Continuous	I <sub>C</sub>	100	mA

### Thermal Characteristics

Characteristics	Symbol	Max	Unit
Total Device Dissipation FR-5 Board FR-4 Board <sup>(1)</sup> T <sub>A</sub> =25°C Derate above 25°C	P <sub>D</sub>	200 1.6	mW mW/°C
Thermal Resistance, Junction to Ambient <sup>(1)</sup>	R <sub>θJA</sub>	600	°C/W
Total Device Dissipation FR-5 Board FR-4 Board <sup>(2)</sup> T <sub>A</sub> =25°C Derate above 25°C	P <sub>D</sub>	300 2.4	mW mW/°C
Thermal Resistance, Junction to Ambient <sup>(2)</sup>	R <sub>θJA</sub>	400	°C/W
Junction Temperature Range	T <sub>J</sub>	-55 to +150	°C
Storage Temperature Range	T <sub>stg</sub>	-55 to +150	°C

1.FR-4 @ Minimum pad

2.FR-4 @1.0 x 1.0 Inch pad

### Device Marking and Resistor Values

Device	Marking	R1(K)	R2(K)
DTC114EE	8A	10	10
DTC124EE	8B	22	22
DTC144EE	8C	47	47
DTC114YE	8D	10	47
DTC114TE	94	10	∞
DTC143TE	8F	4.7	∞

Device	Marking	R1(K)	R2(K)
DTC123EE	8H	2.2	2.2
DTC143EE	8J	4.7	4.7
DTC143ZE	8K	4.7	47
DTC124XE	8L	22	47
DTC123JE	8M	2.2	47
DTC115EE	8N	100	100
DTC144WE	8P	47	22

## Electrical Characteristics (T<sub>A</sub>=25°C Unless Otherwise noted)

Characteristics	Symbol	Min	Typ	Max	Unit
-----------------	--------	-----	-----	-----	------

### Off Characteristics

Collector-Emitter Breakdown Voltage <sup>(2)</sup> I <sub>C</sub> =2.0mA, I <sub>B</sub> =0	V <sub>(BR)CEO</sub>	50	-	-	V	
Collector-Base Breakdown Voltage I <sub>C</sub> =10μA, I <sub>E</sub> =0	V <sub>(BR)CBO</sub>	50	-	-	V	
Collector-Base Cutoff Voltage V <sub>CB</sub> =50V, I <sub>E</sub> =0	I <sub>CBO</sub>	-	-	100	nA	
Collector-Emitter Cutoff Current V <sub>CE</sub> =50V, I <sub>B</sub> =0	I <sub>CEO</sub>	-	-	500	nA	
Emitter-Base Cutoff Current V <sub>EB</sub> =6.0V, I <sub>C</sub> =0	DTC114EE DTC124EE DTC144EE DTC114YE DTC114TE DTC143TE DTC123EE DTC143EE DTC143ZE DTC124XE DTC123JE DTC115EE DTC144WE	I <sub>EBO</sub>	- - - - - - - - - - - - -	- - - - - - - - - - - - -	0.5 0.2 0.1 0.2 0.9 1.9 2.3 1.5 0.18 0.13 0.2 0.05 0.13	mA

2. Pulse Test: Pulse Width < 300us, Duty Cycle < 2.0%

## Electrical Characteristics (TA=25°C Unless Otherwise noted)

Characteristics	Symbol	Min	Typ	Max	Unit
<b>On Characteristics<sup>(3)</sup></b>					
DC Current Gain $V_{CE}=-10V, I_C=5.0mA$	DTC114EE	35	60	-	-
	DTC124EE	60	100	-	
	DTC144EE	80	140	-	
	DTC114YE	80	140	-	
	DTC114TE	160	250	-	
	DTC143TE	160	250	-	
	DTC123EE	8.0	15	-	
	DTC143EE	15	27	-	
	DTC143ZE	80	140	-	
	DTC124XE	80	130	-	
	DTC123JE	80	140	-	
	DTC115EE	80	150	-	
	DTC144WE	80	140	-	
	Collector-Emitter Saturation Voltage $I_C=10mA, I_E=0.3mA$ $I_C=10mA, I_E=5.0mA$ $I_C=10mA, I_E=1.0mA$	DTC123EE	-	-	
DTC114TE / DTC143TE					
DTC143ZE / DTC124XE					
DTC143EE					
Output Voltage(on) $V_{CC}=5.0V, V_B=2.5V R_L=1.0K\Omega$  $V_{CC}=5.0V, V_B=3.5V R_L=1.0K\Omega$ $V_{CC}=5.0V, V_B=5.5V R_L=1.0K\Omega$ $V_{CC}=5.0V, V_B=4.0V R_L=1.0K\Omega$	DTC114EE	-	-	0.2	V
	DTC124EE				
	DTC144EE				
	DTC114YE				
	DTC114TE				
	DTC143TE				
	DTC123EE				
	DTC143EE				
	DTC143ZE				
	DTC124XE				
	DTC123JE				
	DTC115EE				
	DTC144WE				

3. Pulse Test: Pulse Width < 300us, Duty Cycle < 2.0%

## Electrical Characteristics (TA=25°C Unless Otherwise noted)

Characteristics	Symbol	Min	Typ	Max	Unit
<b>On Characteristics<sup>(4)</sup></b>					
Output Voltage(off) V <sub>CC</sub> =5.0V, V <sub>B</sub> =0.5V R <sub>L</sub> =1.0KΩ V <sub>CC</sub> =5.0V, V <sub>B</sub> =0.25V R <sub>L</sub> =1.0KΩ	DTC114TE DTC143TE DTC143ZE V <sub>OH</sub>	4.9	-	-	V
Input Resistor	DTC114EE DTC124EE DTC144EE DTC114YE DTC114TE DTC143TE DTC123EE DTC143EE DTC143ZE DTC124XE DTC123JE DTC115EE DTC144WE R1	7.0 15.4 32.9 7.0 7.0 3.3 1.5 3.3 3.3 15.4 15.4 70 32.9	10 22 47 10 10 4.7 2.2 4.7 4.7 22 2.2 100 47	13 28.6 61.1 13 13 6.1 2.9 6.1 6.1 28.6 2.86 130 61.1	kΩ
Resistor Ratio	DTC114EE / DTC124EE DTC144EE / DTC115EE DTC114YE DTC114TE / DTC143TE DTC123EE / DTC143EE DTC143ZE DTC124XE DTC123JE DTC144WE R1/R2	0.8 0.17 - 0.8 0.055 0.38 0.038 1.7	1.0 0.21 - 1.0 0.1 0.47 0.047 2.1	1.2 0.25 - 1.2 0.185 0.56 0.056 2.6	-

4. PulseTest: Pulse Width < 300us, Duty Cycle < 2.0%

DTC114EE Series

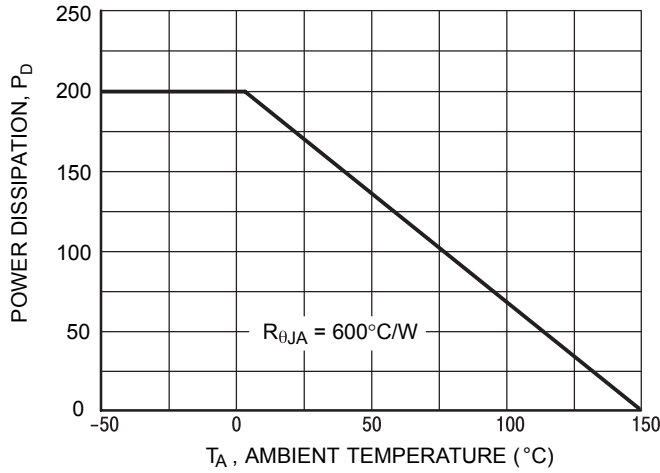

Figure 1. Derating Curve

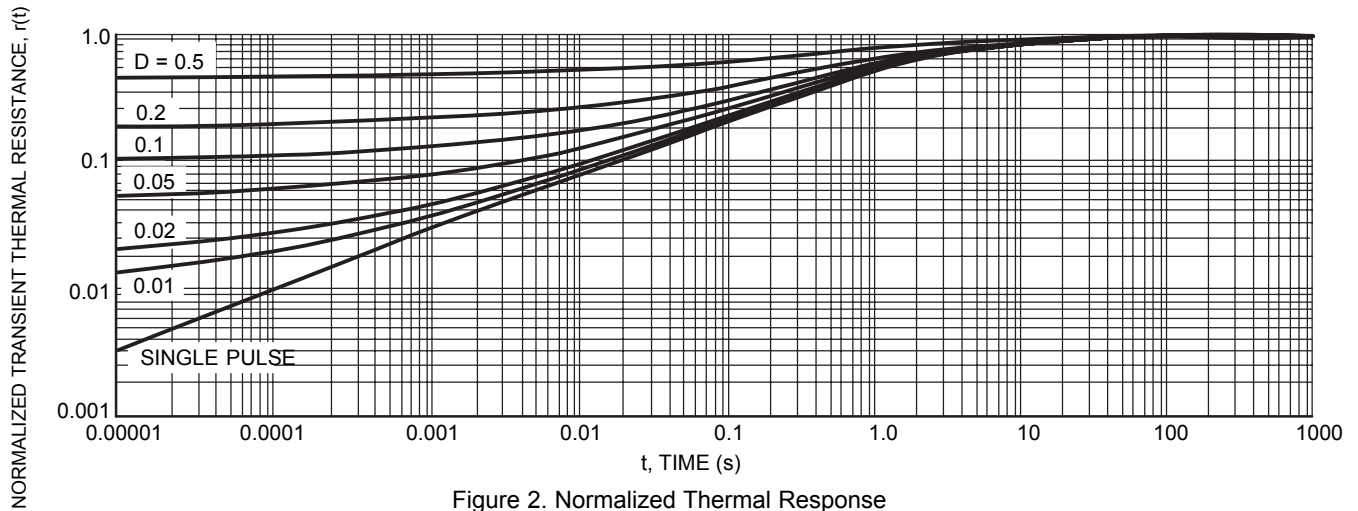

Figure 2. Normalized Thermal Response

TYPICAL ELECTRICAL CHARACTERISTICS – DTC114EE

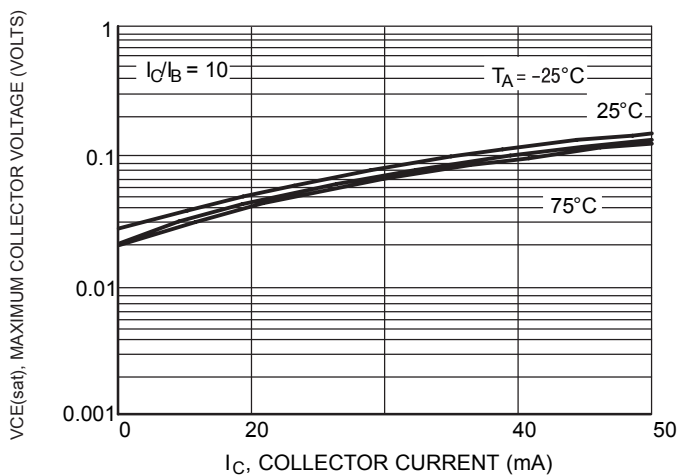

Figure 3.  $V_{CE(sat)}$  versus  $I_C$

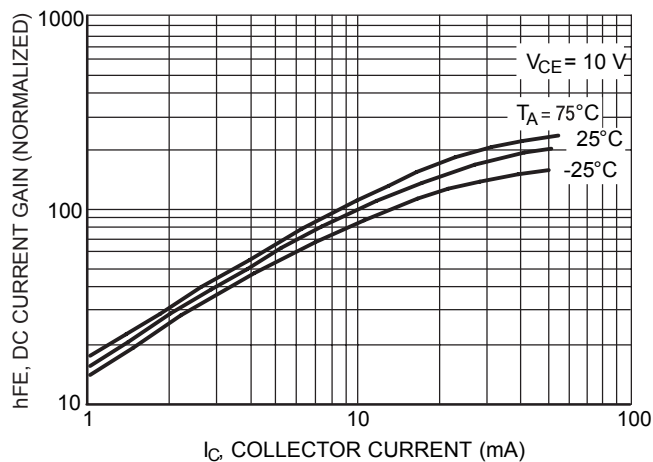

Figure 4. DC Current Gain

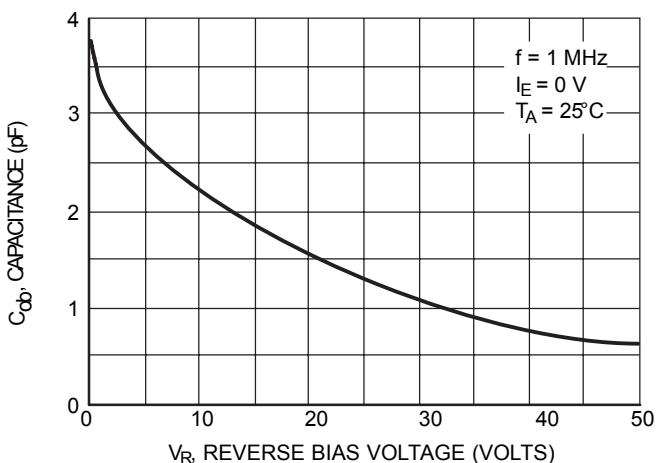

Figure 5. Output Capacitance

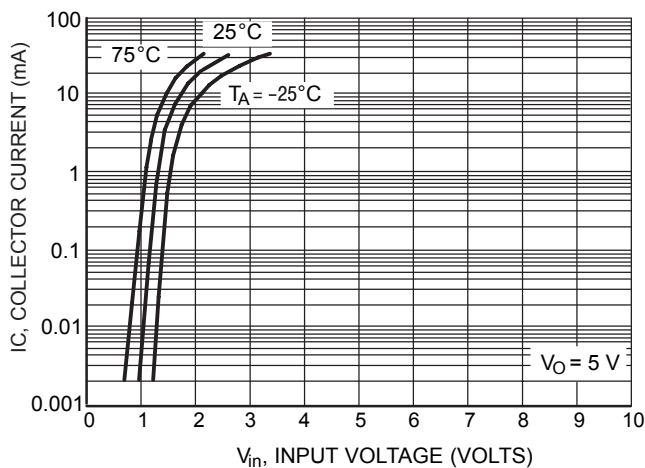

Figure 6. Output Current versus Input Voltage

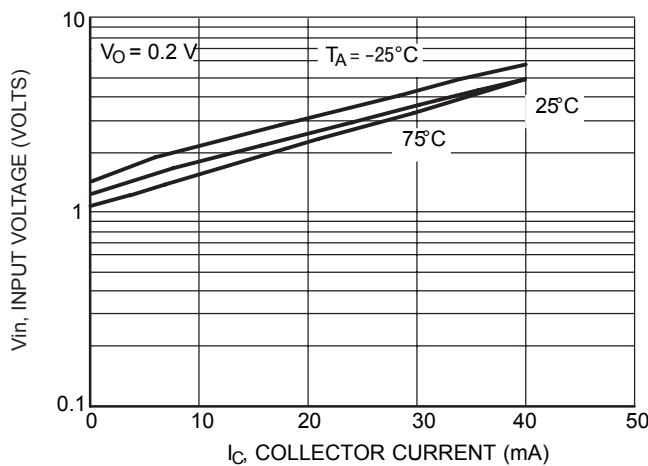

Figure 7. Input Voltage versus Output Current

TYPICAL ELECTRICAL CHARACTERISTICS – DTC123EE

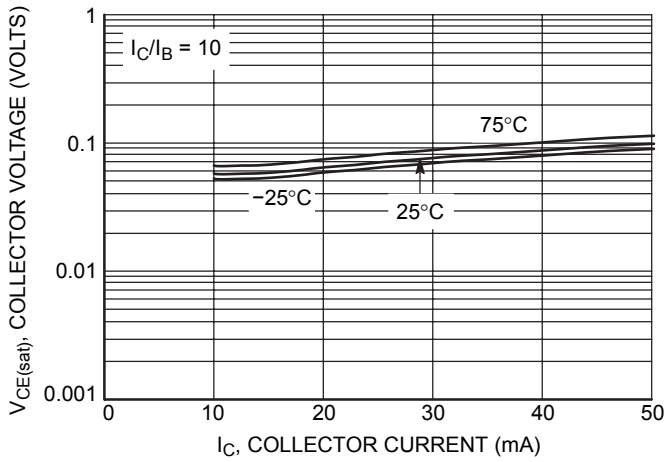

Figure 8.  $V_{CE(sat)}$  versus  $I_C$

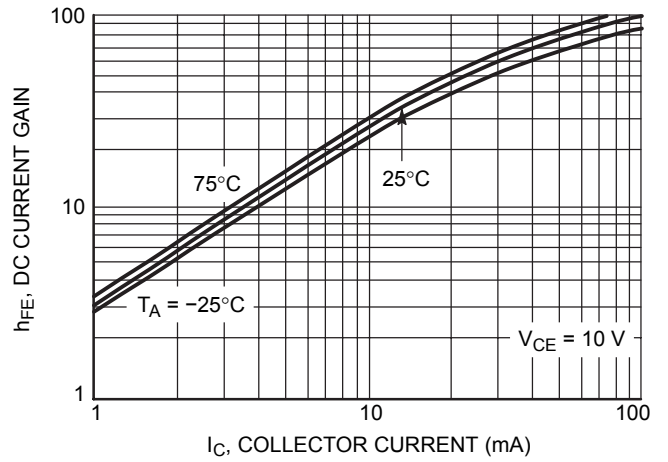

Figure 9. DC Current Gain

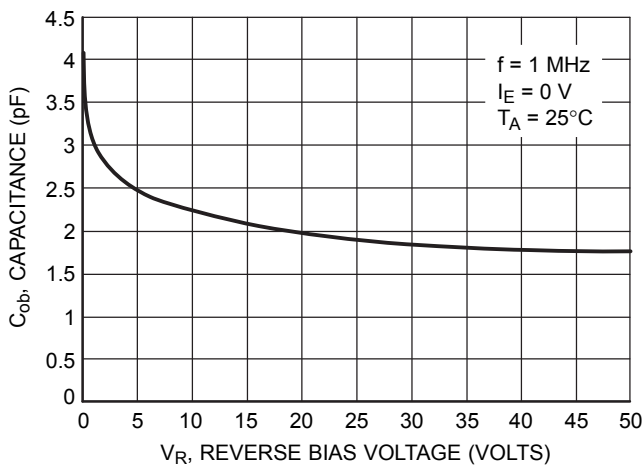

Figure 10. Output Capacitance

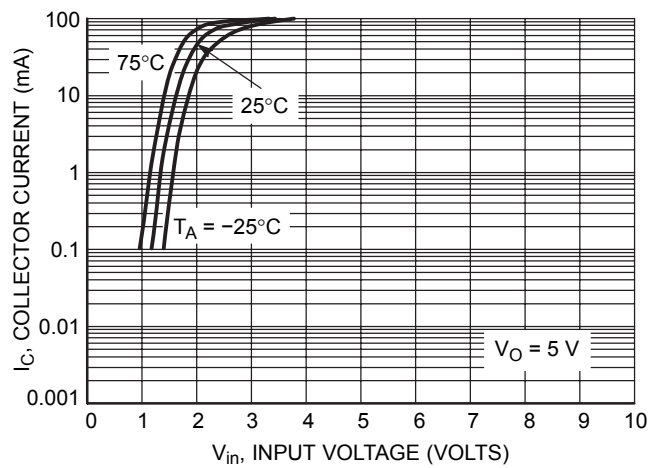

Figure 11. Output Current versus Input Voltage

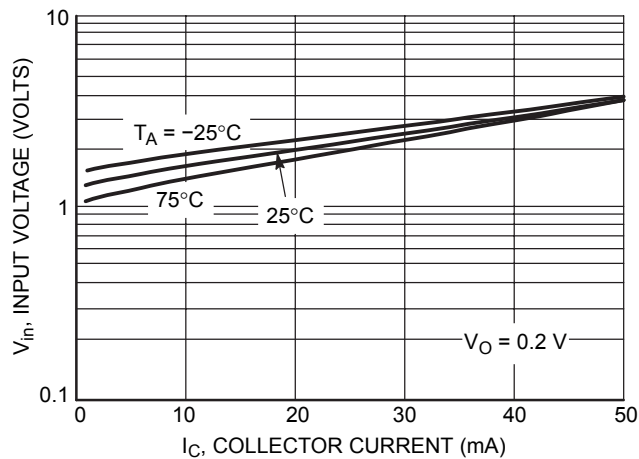

Figure 12. Input Voltage versus Output Current

TYPICAL ELECTRICAL CHARACTERISTICS – DTC124EE

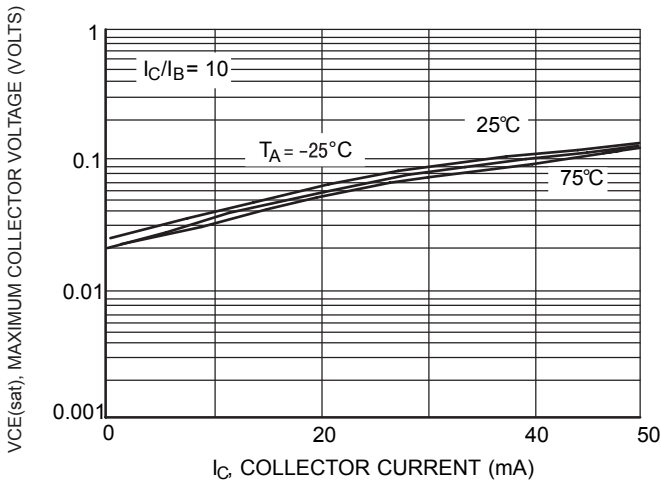

Figure 13.  $V_{CE(sat)}$  versus  $I_C$

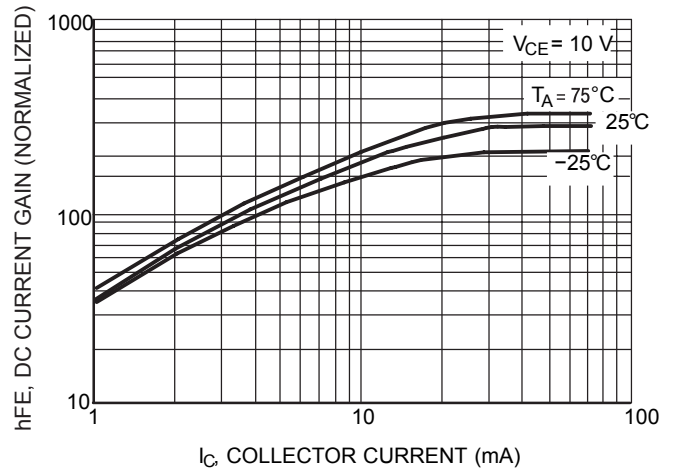

Figure 14. DC Current Gain

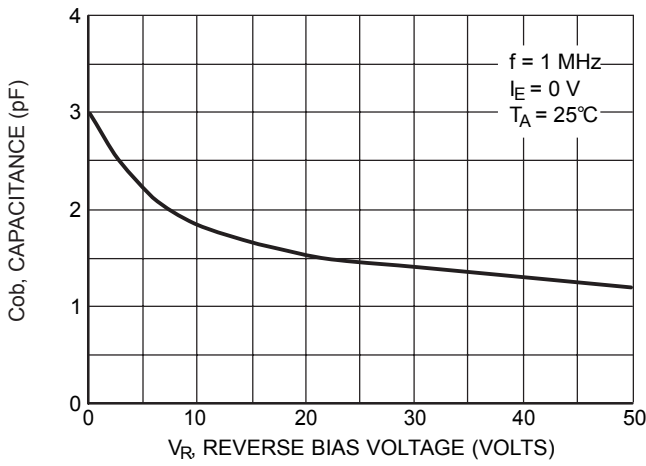

Figure 15. Output Capacitance

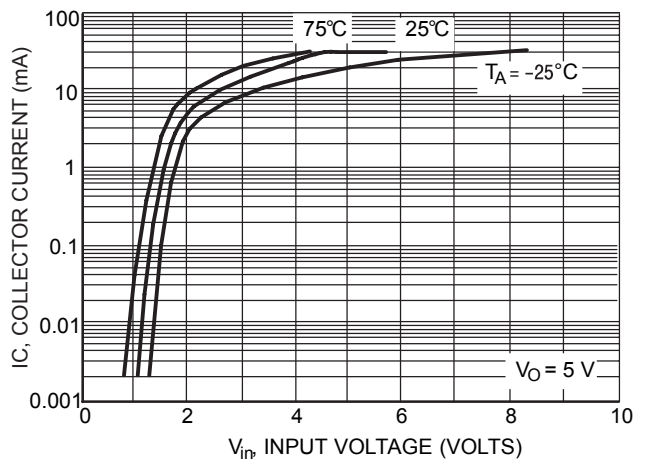

Figure 16. Output Current versus Input Voltage

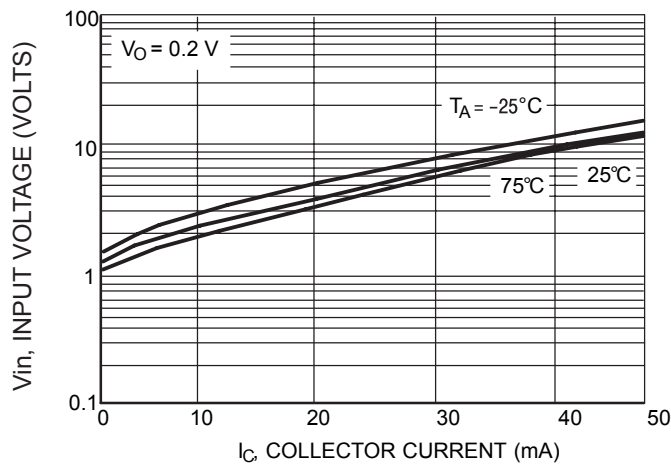

Figure 17. Input Voltage versus Output Current



TYPICAL ELECTRICAL CHARACTERISTICS - DTC114EE

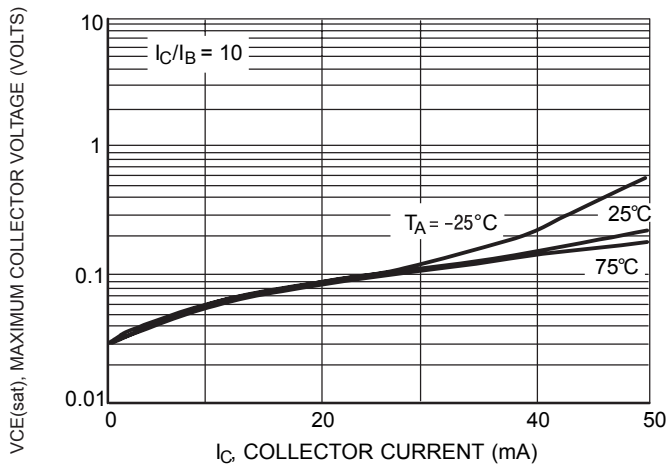

Figure 18.  $V_{CE(sat)}$  versus  $I_C$

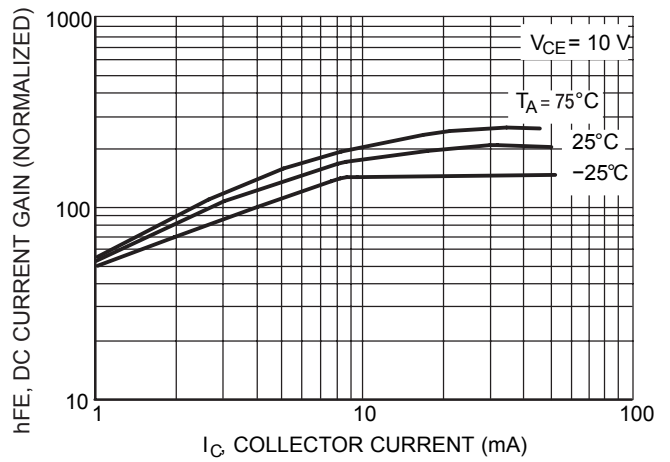

Figure 19. DC Current Gain

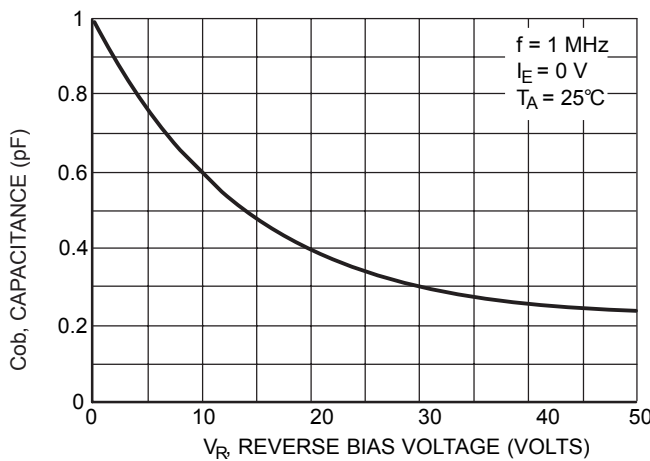

Figure 20. Output Capacitance

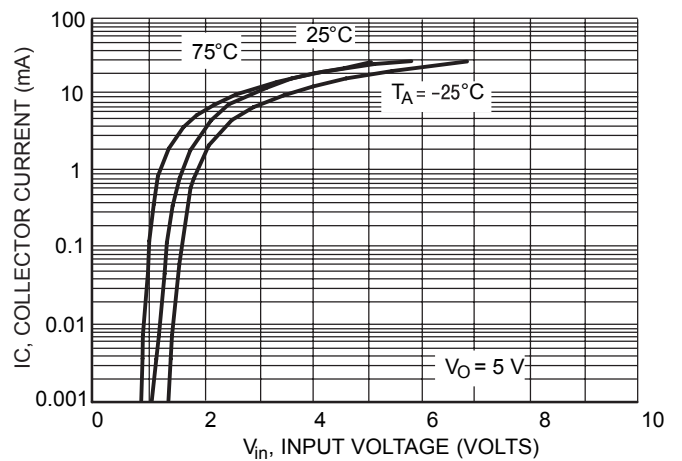

Figure 21. Output Current versus Input Voltage

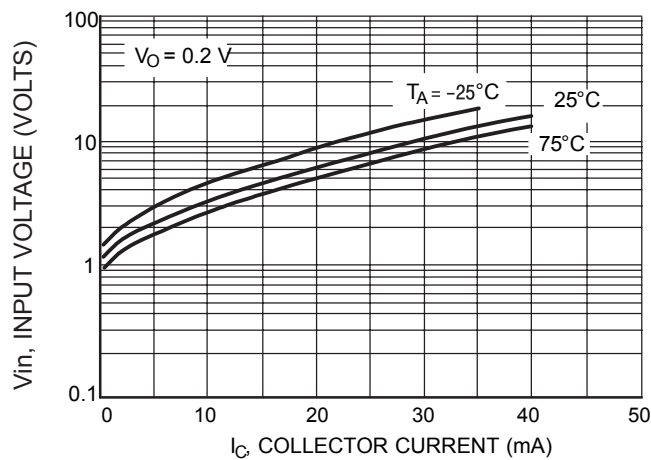

Figure 22. Input Voltage versus Output Current

## TYPICAL ELECTRICAL CHARACTERISTICS – DTC114YE

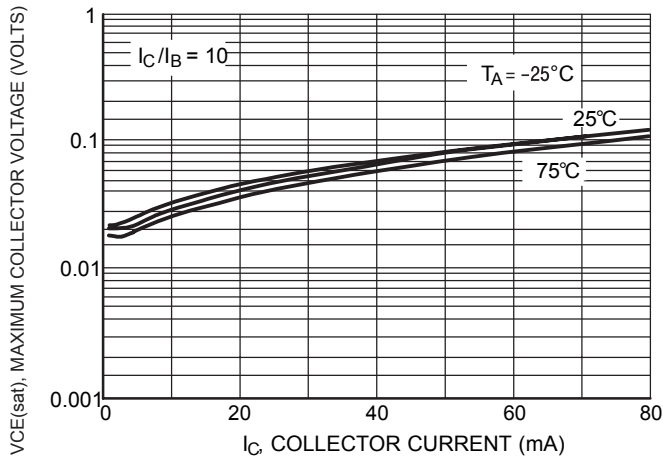

Figure 23.  $V_{CE(sat)}$  versus  $I_C$

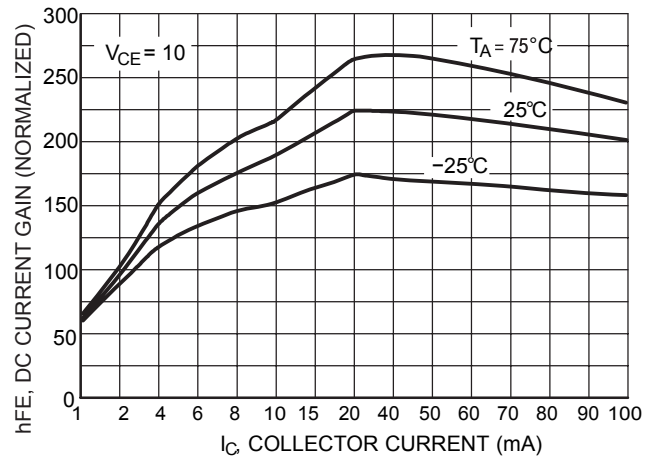

Figure 24. DC Current Gain

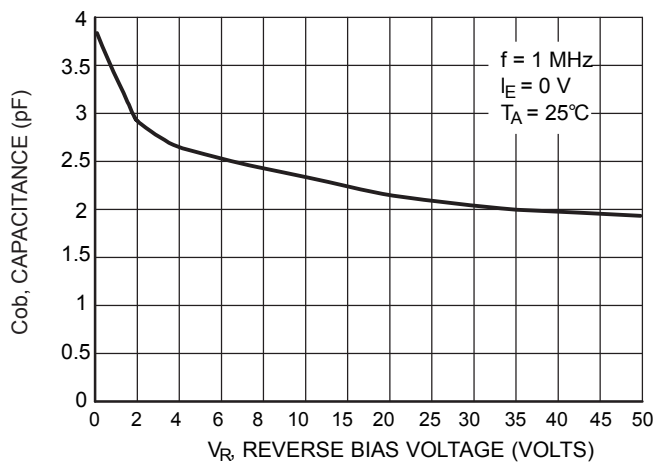

Figure 25. Output Capacitance

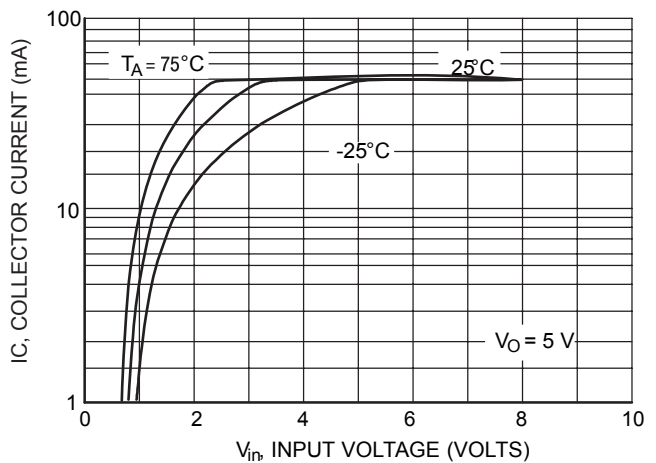

Figure 26. Output Current versus Input Voltage

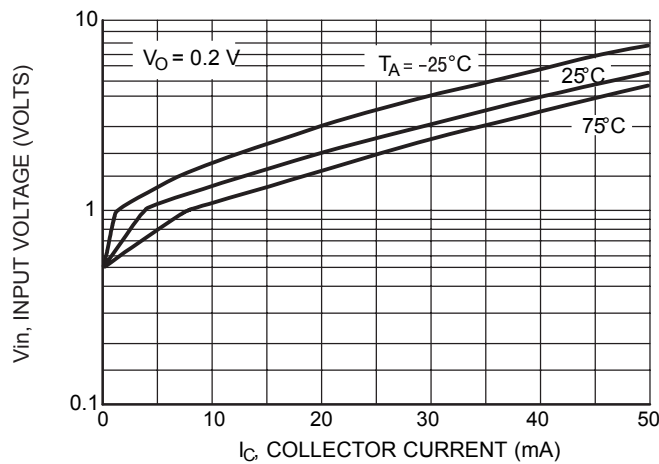

Figure 27. Input Voltage versus Output Current

TYPICAL ELECTRICAL CHARACTERISTICS — DTA115EE1

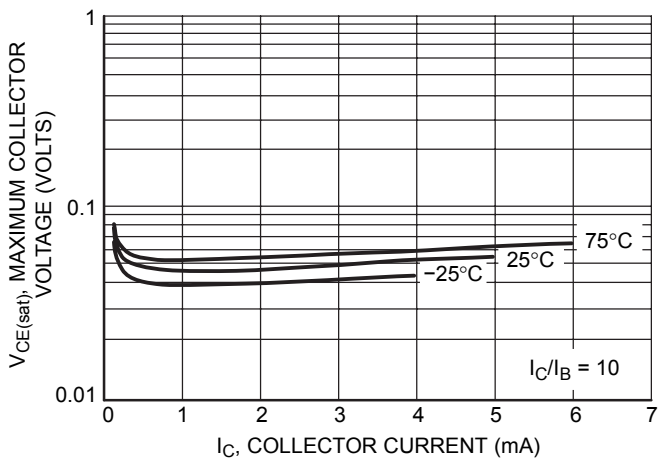

Figure 29. Maximum Collector Voltage versus Collector Current

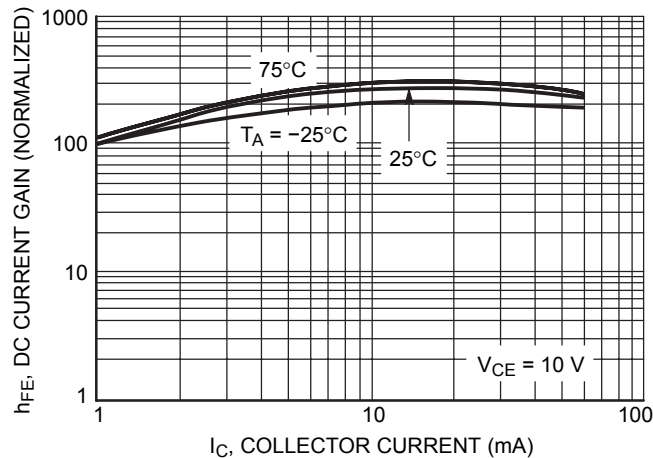

Figure 30. DC Current Gain

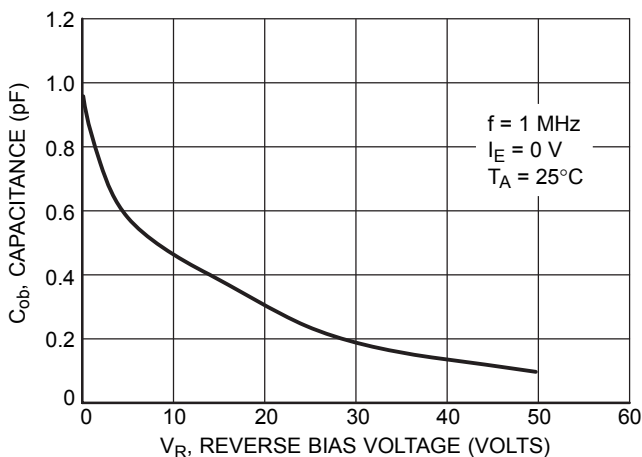

Figure 31. Output Capacitance

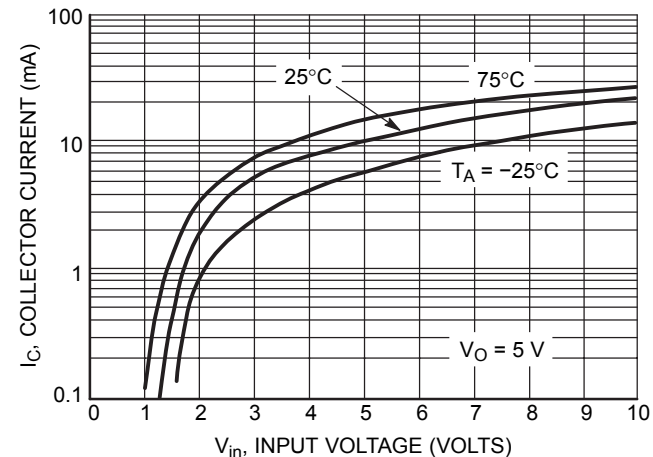

Figure 32. Output Current versus Input Voltage

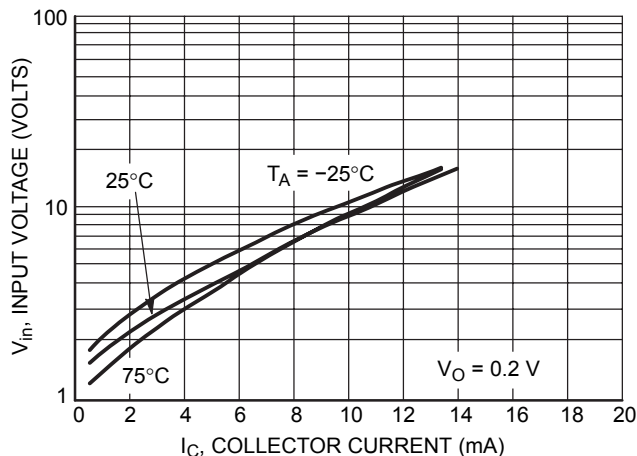

Figure 33. Input Voltage versus Output Current

TYPICAL APPLICATIONS FOR NPN BRTs

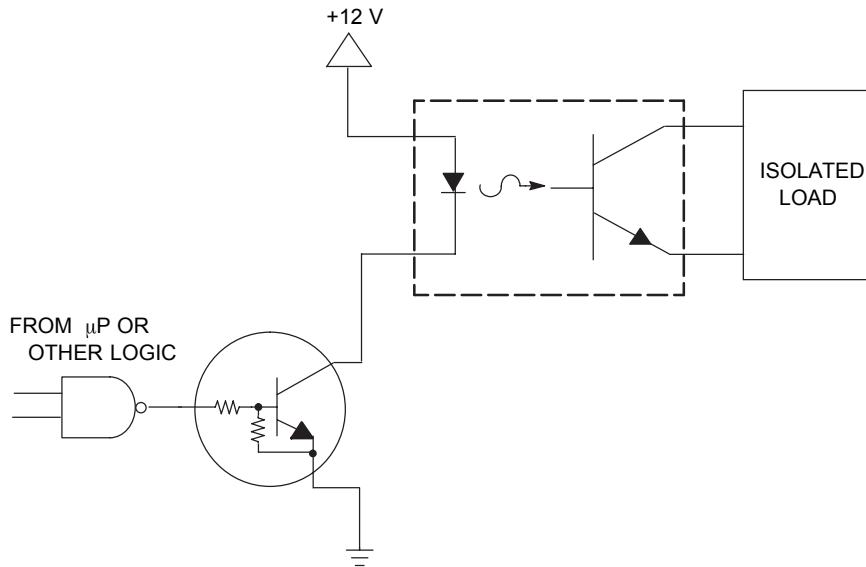

Figure 28. Level Shifter: Connects 12 or 24 Volt Circuits to Logic

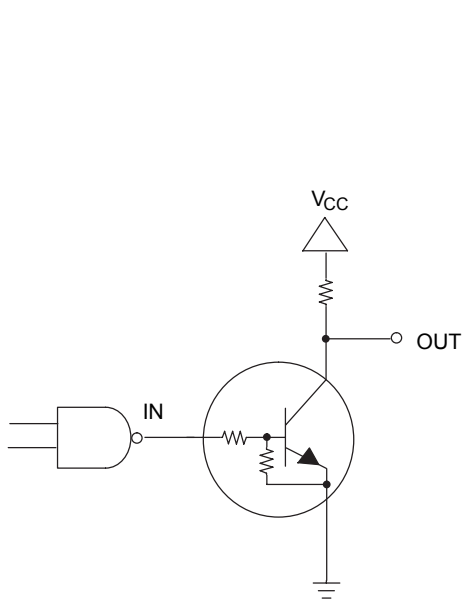

Figure 29. Open Collector Inverter: Inverts the Input Signal

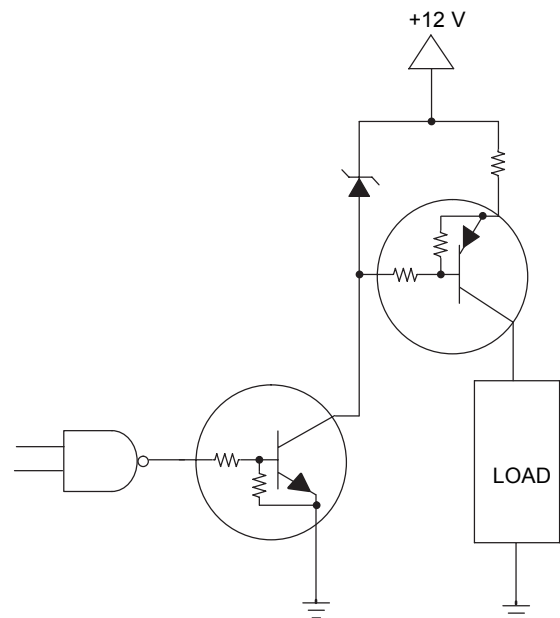
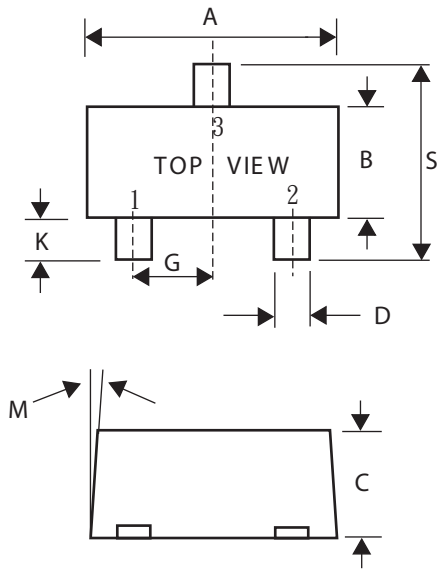

Figure 30. Inexpensive, Unregulated Current Source

SC-89 Outline Demensions

Unit:mm



SC-89			
Dim	Min	Nom	Max
A	1.50	1.60	1.70
B	0.75	0.85	0.95
C	0.60	0.70	0.80
D	0.23	0.28	0.33
G	0.50BSC		
J	0.10	0.15	0.20
K	0.30	0.40	0.50
M	---	---	10°
N	---	---	10°
S	1.50	1.60	1.70