



## 88CXX

CMOS IC

### BUILT-IN DELAY CIRCUIT HIGH-PRECISION VOLTAGE DETECTOR

#### DESCRIPTION

The UTC **88CXX** series are highly accurate, low power consumption voltage detector, manufactured using CMOS process. The detection voltage is fixed internally, with an accuracy of  $\pm 2.0\%$ . Besides, UTC **88CXX** can easily delay a release signal by attachment of an external capacitor with built-in delay circuit.

#### FEATURES

- \* Highly accurate : 2.0%
- \* Hysteresis characteristics: 5% typ.
- \* Ultra-low current consumption: 1.0 $\mu$ A typ. ( $V_{DD}=2.0V$ )
- \* Detection voltage ranges: 1.6~6V and step by 0.1V.
- \* Low operating voltage based on detection voltage
- \* Delay time setting by an additional external capacitor

#### ORDERING INFORMATION

Ordering Number		Package	Packing
Lead Free	Halogen Free		
88CXXL-AE5-R	88CXXG-AE5-R	SOT-23-5	Tape Reel
88CXXL-AF5-R	88CXXG-AF5-R	SOT-25	Tape Reel

<p>88CXXG-AF5-R</p>	<p>(1) Packing Type</p> <p>(2) Package Type</p> <p>(3) Green Package</p> <p>(4) Output Voltage Code</p>	<p>(1) R: Tape Reel</p> <p>(2) AE5: SOT-23-5, AF5: SOT-25</p> <p>(3) G: Halogen Free and Lead Free, L: Lead Free</p> <p>(4) XX: refer to Marking Information</p>
---------------------	---	--

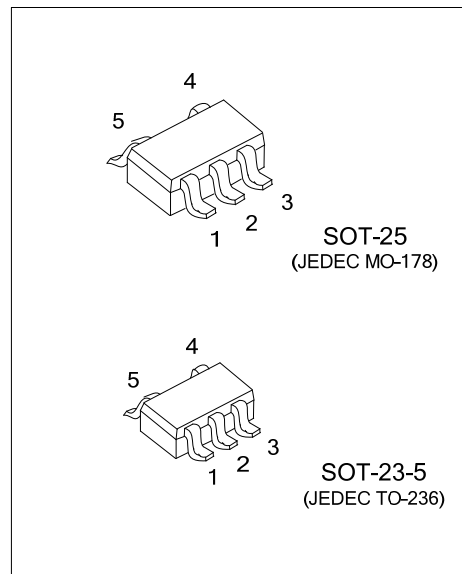

### MARKING INFORMATION

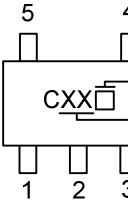
PACKAGE	VOLTAGE CODE			MARKING
SOT-25 SOT-23-5	16:1.6V	29:2.9V	42:4.2V	 L: Lead Free G: Halogen Free Voltage Code
	17:1.7V	30:3.0V	43:4.3V	
	18:1.8V	31:3.1V	44:4.4V	
	19:1.9V	32:3.2V	45:4.5V	
	20:2.0V	33:3.3V	46:4.6V	
	21:2.1V	34:3.4V	47:4.7V	
	22:2.2V	35:3.5V	48:4.8V	
	23:2.3V	36:3.6V	49:4.9V	
	24:2.4V	37:3.7V	50:5.0V	
	25:2.5V	38:3.8V	51:5.1V	
	26:2.6V	39:3.9V	52:5.2V	
	27:2.7V	40:4.0V	53:5.3V	
	28:2.8V	41:4.1V	60:6.0V	

### PIN CONFIGURATION

PIN NO.	PIN NAME
1	V <sub>OUT</sub>
2	V <sub>DD</sub>
3	V <sub>SS</sub>
4	NC
5	C <sub>D</sub>

### BLOCK DIAGRAMS

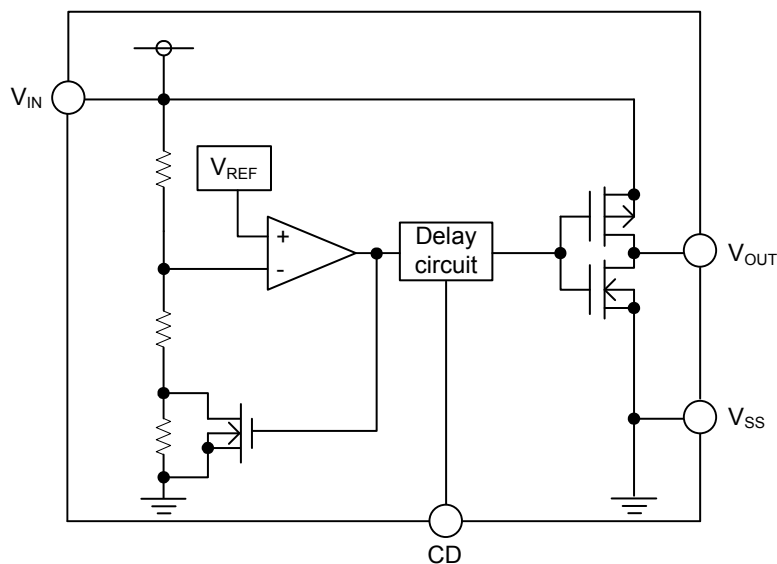

■ ABSOLUTE MAXIMUM RATINGS ( $T_A=25^\circ\text{C}$ , unless otherwise specified.)

PARAMETER	SYMBOL	RATINGS	UNIT
Power Supply Voltage	$V_{DD}-V_{SS}$	12	V
$C_D$ Terminal Input Voltage	$V_{CD}$	$V_{SS}-0.3 \sim V_{DD} +0.3$	V
Output Voltage	$V_{OUT}$	$V_{SS}-0.3 \sim V_{DD}+0.3$	V
Output Current	$I_{OUT}$	50	mA
Power Dissipation	$P_D$	250	mW
Operating Temperature	$T_{OPR}$	-40 ~ +85	$^\circ\text{C}$
Storage Temperature	$T_{STG}$	-40 ~ +150	$^\circ\text{C}$

Note: Absolute maximum ratings are those values beyond which the device could be permanently damaged. Absolute maximum ratings are stress ratings only and functional device operation is not implied.

■ ELECTRICAL CHARACTERISTICS ( $T_A=25^\circ\text{C}$ , unless otherwise specified.)

**Detection voltage (1.6V ~ 2.6V)**

PARAMETER	SYMBOL	TEST CONDITONS	MIN	TYP	MAX	UNIT
Detect Voltage	$V_{DET}$		$-V_{DET}$ $\times 0.98$	$-V_{DET}$	$-V_{DET}$ $\times 1.02$	V
Hysteresis Range	$V_{HYS}$		$-V_{DET}$ $\times 0.02$	$-V_{DET}$ $\times 0.05$	$-V_{DET}$ $\times 0.08$	V
Supply Current	$I_{SS}$	$V_{DD}=3.5V$		1.2	5.0	$\mu\text{A}$
Operating Voltage	$V_{DD}$		0.95		10.0	V
Output Current	$I_{OUT}$	N-CH $V_{DS}=0.5V$	$V_{DD}=1.20V$	0.23	0.50	mA
		P-CH $V_{DS}=0.5V$	$V_{DD}=4.8V$	0.36	0.62	mA
Detect Voltage Temperature Characteristics	$\frac{\Delta V_{DET}}{\Delta T_{OPR} \times V_{DET}}$			$\pm 100$		ppm/ $^\circ\text{C}$
Delay Time	$t_{DLY}$	$V_{DD}=3.5V, C_D=4.7nF$	16	30	42	ms

**Detection voltage (2.7V ~ 3.9V)**

PARAMETER	SYMBOL	TEST CONDITONS	MIN	TYP	MAX	UNIT
Detect Voltage	$V_{DET}$		$-V_{DET}$ $\times 0.98$	$-V_{DET}$	$-V_{DET}$ $\times 1.02$	V
Hysteresis Range	$V_{HYS}$		$-V_{DET}$ $\times 0.02$	$-V_{DET}$ $\times 0.05$	$-V_{DET}$ $\times 0.08$	V
Supply Current	$I_{SS}$	$V_{DD}=4.5V$		1.3	5.0	$\mu\text{A}$
Operating Voltage	$V_{DD}$		0.95		10.0	V
Output Current	$I_{OUT}$	N-CH $V_{DS}=0.5V$	$V_{DD}=1.20V$	0.23	0.50	mA
			$V_{DD}=2.40V$	1.60	3.70	mA
		P-CH $V_{DS}=0.5V$	$V_{DD}=4.8V$	0.36	0.62	mA
Detect Voltage Temperature Characteristics	$\frac{\Delta V_{DET}}{\Delta T_{OPR} \times V_{DET}}$			$\pm 100$		ppm/ $^\circ\text{C}$
Delay Time	$t_{DLY}$	$V_{DD}=4.5V, C_D=4.7nF$	12	28	34	ms

■ ELECTRICAL CHARACTERISTICS (Cont.)

**Detection voltage (4.0V ~ 5.4V)**

PARAMETER	SYMBOL	TEST CONDITONS	MIN	TYP	MAX	UNIT	
Detect Voltage	$V_{DET}$		$-V_{DET}$ $\times 0.98$	$-V_{DET}$	$-V_{DET}$ $\times 1.02$	V	
Hysteresis Range	$V_{HYS}$		$-V_{DET}$ $\times 0.02$	$-V_{DET}$ $\times 0.05$	$-V_{DET}$ $\times 0.08$	V	
Supply Current	$I_{SS}$	$V_{DD}=6.0V$		1.5	5.0	$\mu A$	
Operating Voltage	$V_{DD}$		0.95		10.0	V	
Output Current	$I_{OUT}$	N-CH $V_{DS}=0.5V$	$V_{DD}=1.20V$	0.23	0.50		mA
			$V_{DD}=2.40V$	1.60	3.70		mA
		P-CH $V_{DS}=0.5V$	$V_{DD}=6.0V$	0.46	0.75		mA
Detect Voltage Temperature Characteristics	$\frac{\Delta V_{DET}}{\Delta T_{OPR} \times V_{DET}}$			$\pm 100$		ppm/ $^{\circ}C$	
Delay Time	$t_{DLY}$	$V_{DD}=7.0V, C_D=4.7nF$	12	17	34	ms	

**Detection voltage (5.5V ~ 6.0V)**

PARAMETER	SYMBOL	TEST CONDITONS	MIN	TYP	MAX	UNIT	
Detect Voltage	$V_{DET}$		$-V_{DET}$ $\times 0.98$	$-V_{DET}$	$-V_{DET}$ $\times 1.02$	V	
Hysteresis Range	$V_{HYS}$		$-V_{DET}$ $\times 0.02$	$-V_{DET}$ $\times 0.05$	$-V_{DET}$ $\times 0.08$	V	
Supply Current	$I_{SS}$	$V_{DD}=7.5V$		1.5	5.0	$\mu A$	
Operating Voltage	$V_{DD}$		12			V	
Output Current	$I_{OUT}$	N-CH $V_{DS}=0.5V$	$V_{DD}=1.20V$	0.23	0.50		mA
			$V_{DD}=2.40V$	1.60	3.70		mA
		P-CH $V_{DS}=0.5V$	$V_{DD}=8.4V$	2.08	3.42		mA
Detect Voltage Temperature Characteristics	$\frac{\Delta V_{DET}}{\Delta T_{OPR} \times V_{DET}}$			$\pm 100$		ppm/ $^{\circ}C$	
Delay Time	$t_{DLY}$	$V_{DD}=7.5V, C_D=4.7nF$	12	17	34	ms	

■ DETECTION VOLTAGE RANGE vs. HYSTERESIS WIDTH

DETECTION VOLTAGE RANGE (V)	HYSTERESIS WIDTH $V_{HYS}$ TYP (V)	DETECTION VOLTAGE RANGE (V)	HYSTERESIS WIDTH $V_{HYS}$ TYP (V)
1.6V±2.0%	0.080	3.5V±2.0%	0.175
1.7V±2.0%	0.085	3.7V±2.0%	0.185
1.8V±2.0%	0.090	3.8V±2.0%	0.190
1.9V±2.0%	0.095	3.9V±2.0%	0.195
2.0V±2.0%	0.100	4.0V±2.0%	0.200
2.1V±2.0%	0.105	4.1V±2.0%	0.205
2.2V±2.0%	0.110	4.2V±2.0%	0.210
2.3V±2.0%	0.115	4.3V±2.0%	0.215
2.4V±2.0%	0.120	4.4V±2.0%	0.220
2.5V±2.0%	0.125	4.5V±2.0%	0.225
2.6V±2.0%	0.130	4.6V±2.0%	0.230
2.7V±2.0%	0.135	4.7V±2.0%	0.235
2.8V±2.0%	0.140	4.8V±2.0%	0.240
2.9V±2.0%	0.145	4.9V±2.0%	0.245
3.0V±2.0%	0.150	5.0V±2.0%	0.250
3.1V±2.0%	0.155	5.1V±2.0%	0.255
3.2V±2.0%	0.160	5.2V±2.0%	0.260
3.3V±2.0%	0.165	5.3V±2.0%	0.265
3.4V±2.0%	0.170	6.0V±2.0%	0.300

■ OUTPUT CONFIGURATIONS

Implementation	CMOS
With different power supplies	No
With active low reset CPUs	Yes
With active high reset CPUs	No
With voltage divider variable resistors	No

Example with one power supply

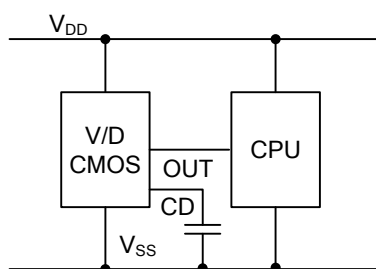

■ TYPICAL CHARACTERISTICS

88C25

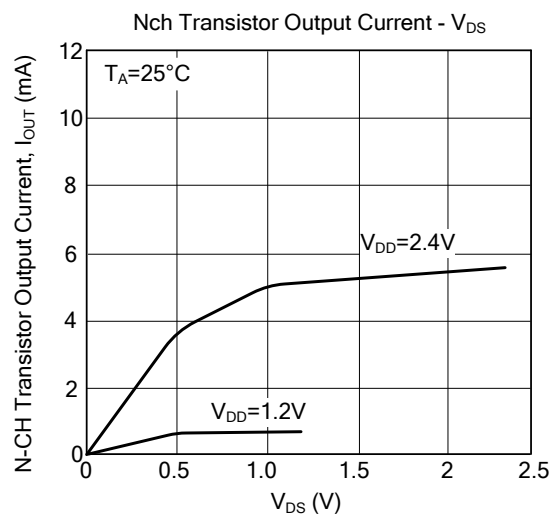
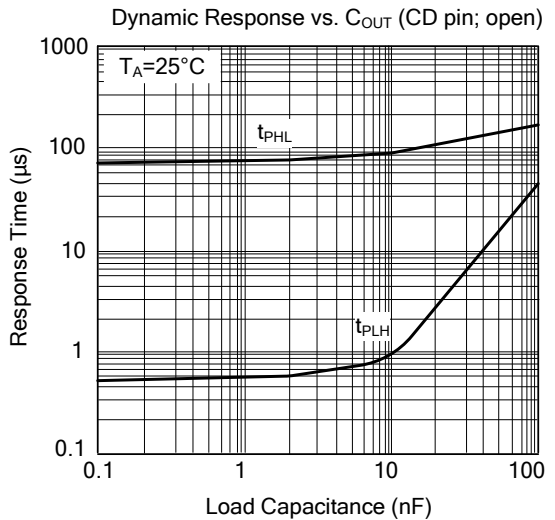
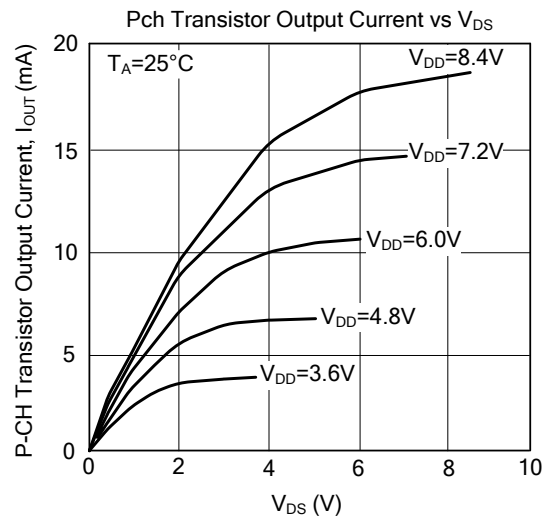
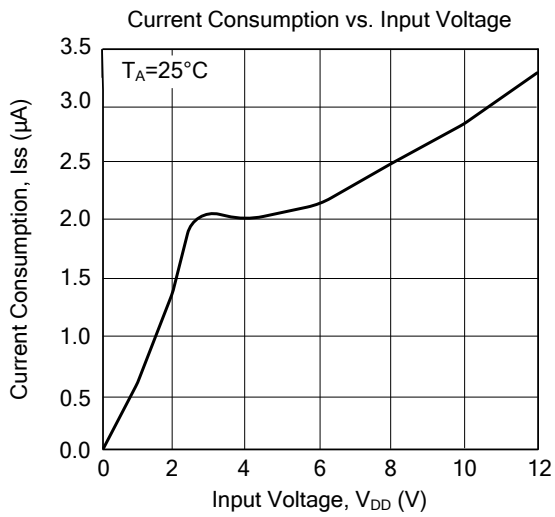
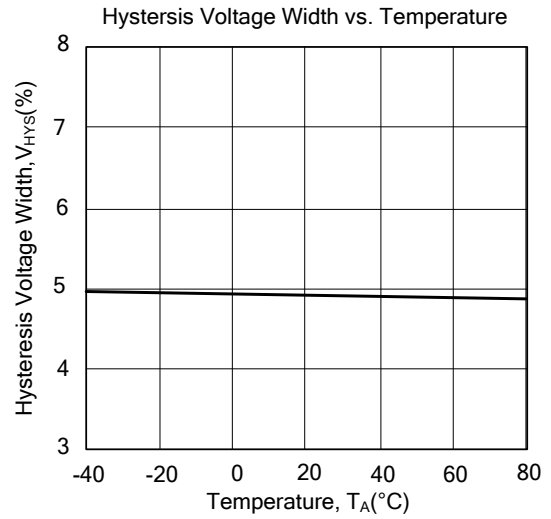
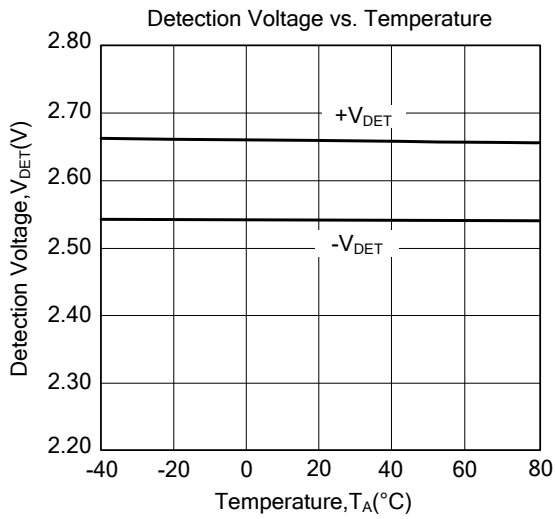

■ TYPICAL CHARACTERISTICS (Cont.)

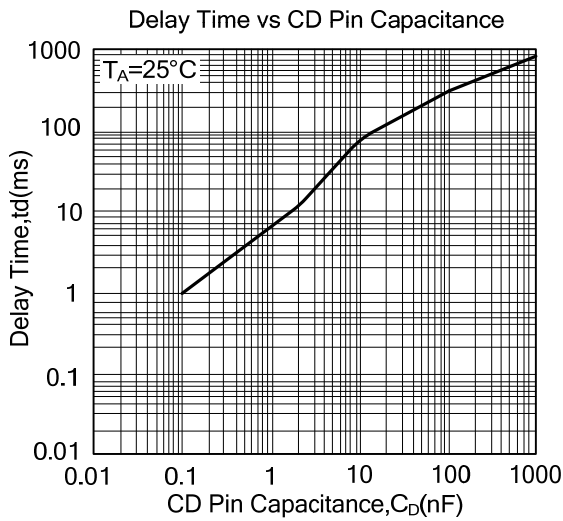
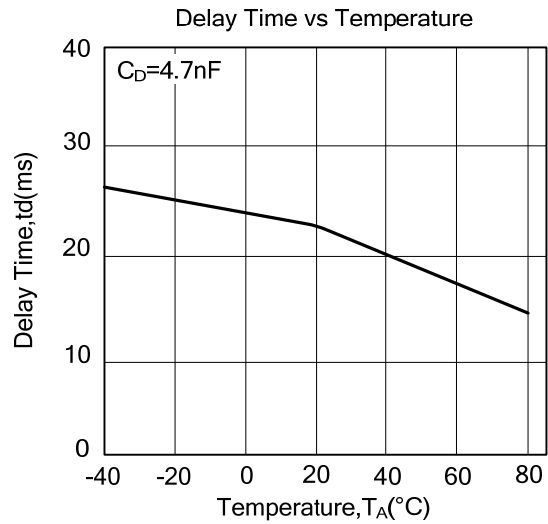
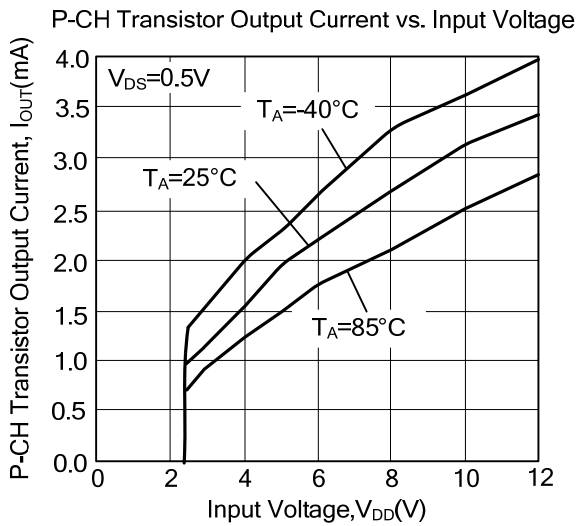
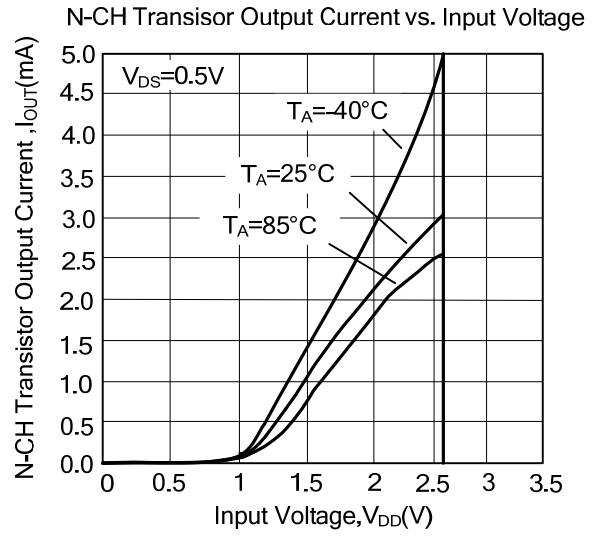
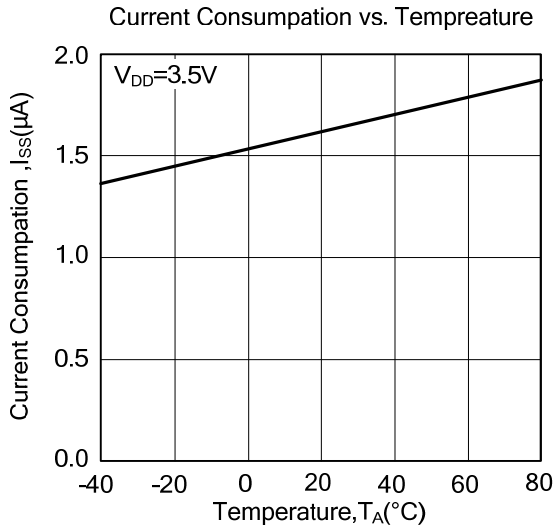

■ TYPICAL CHARACTERISTICS (Cont.)

88C28

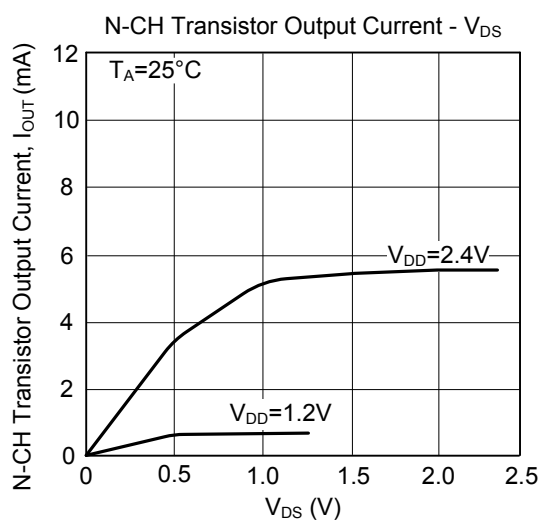
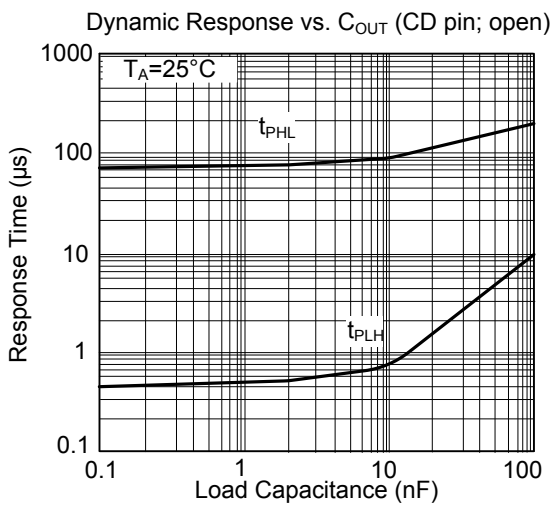
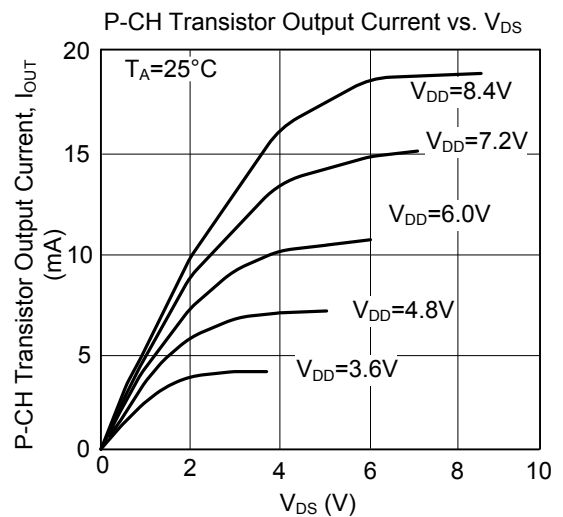
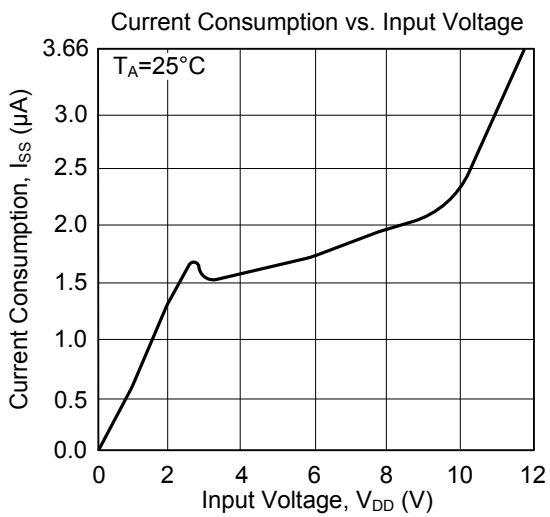
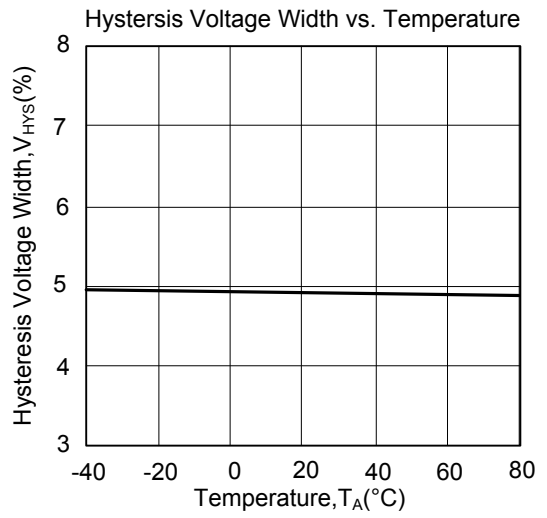
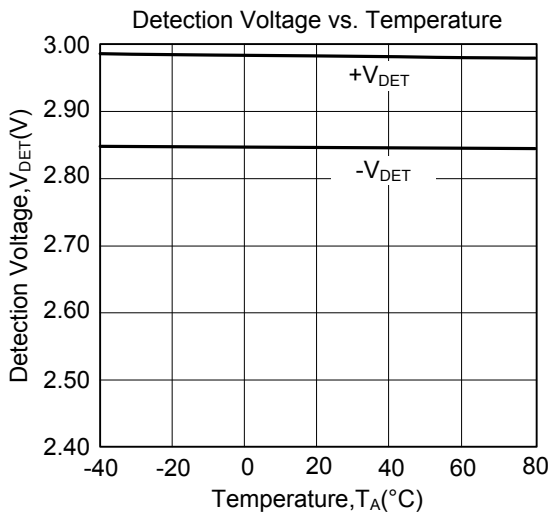



■ TYPICAL CHARACTERISTICS (Cont.)

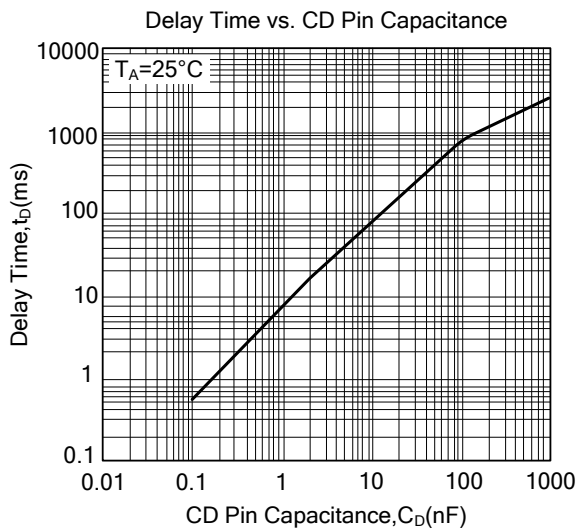
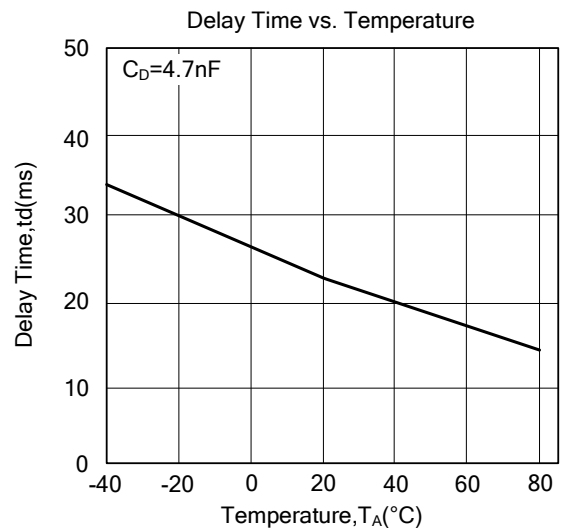
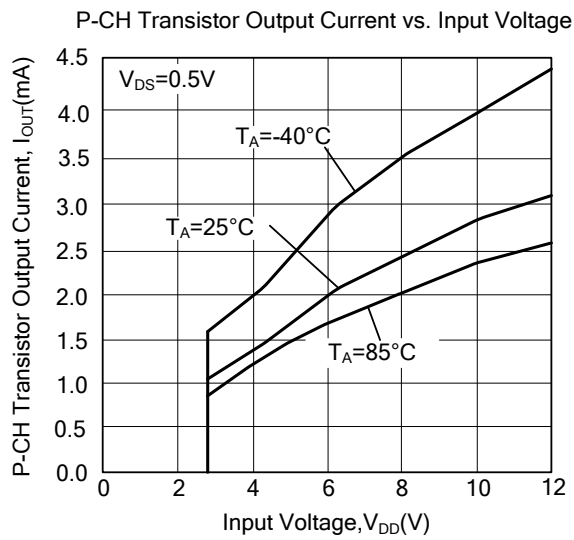
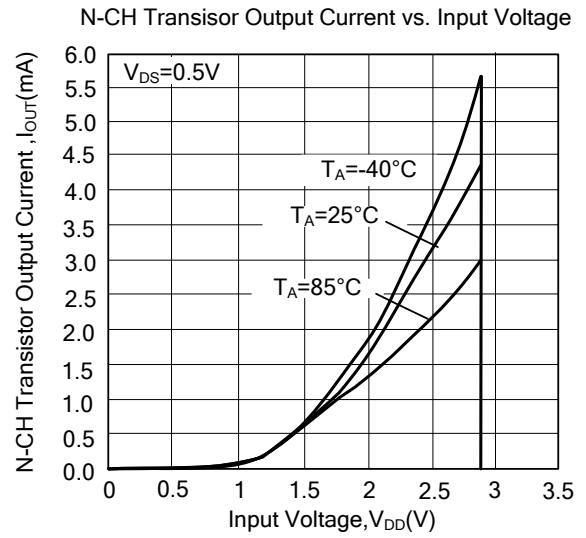
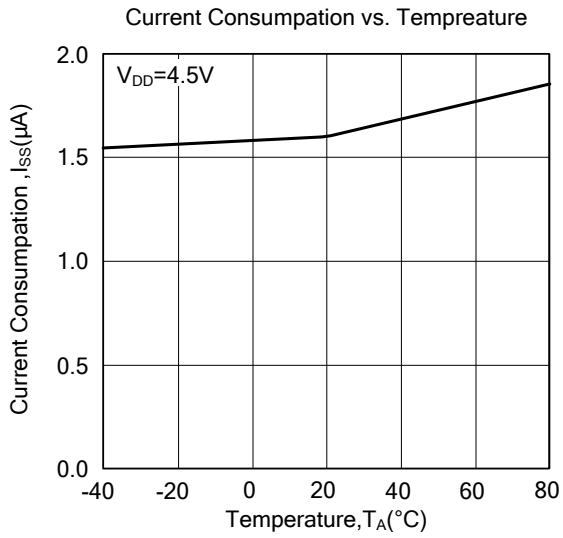

■ TYPICAL CHARACTERISTICS (Cont.)

88C33

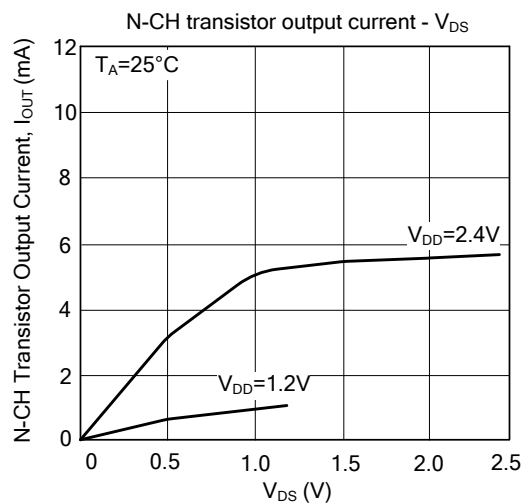
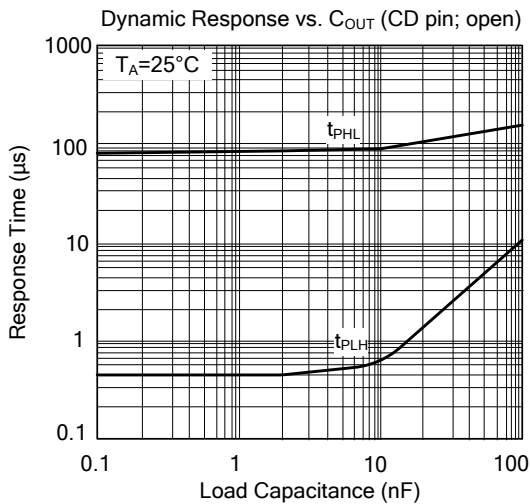
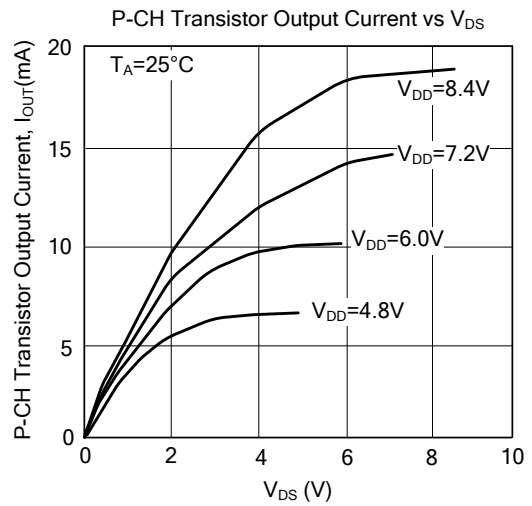
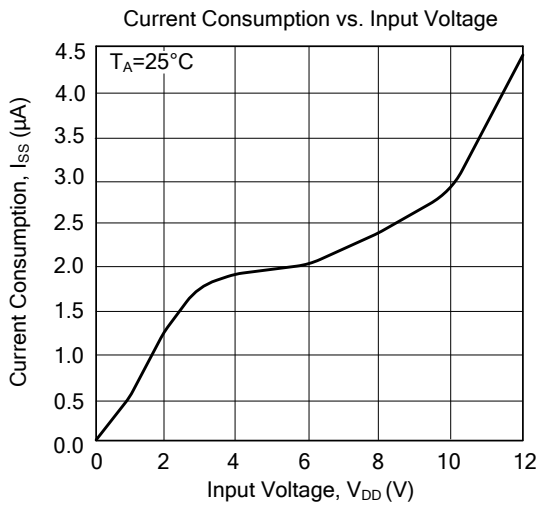
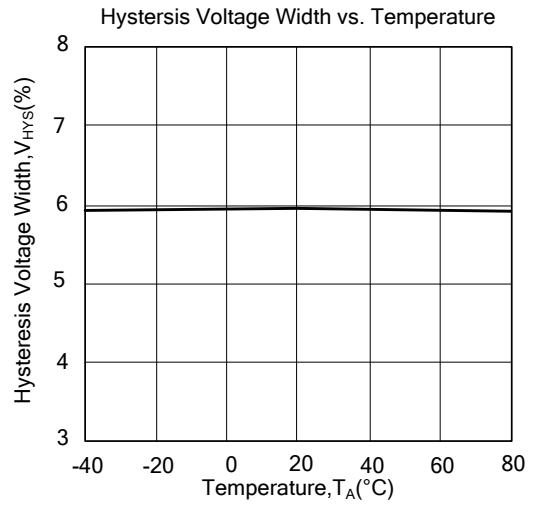
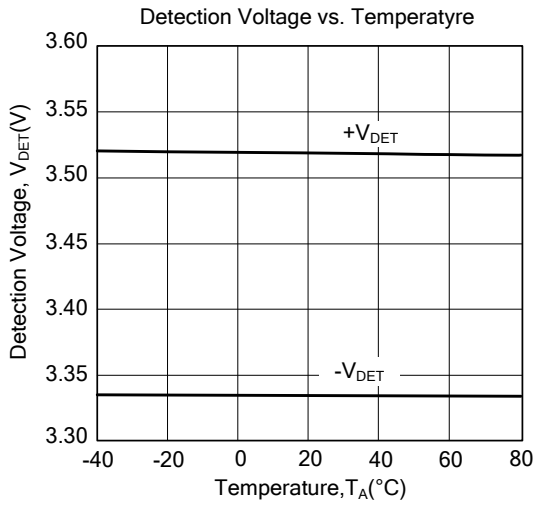

■ TYPICAL CHARACTERISTICS (Cont.)

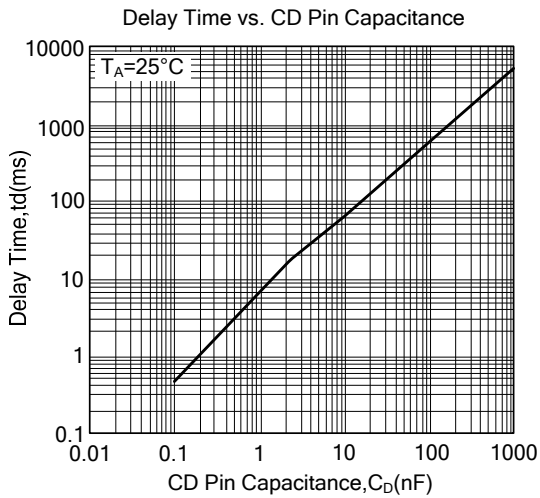
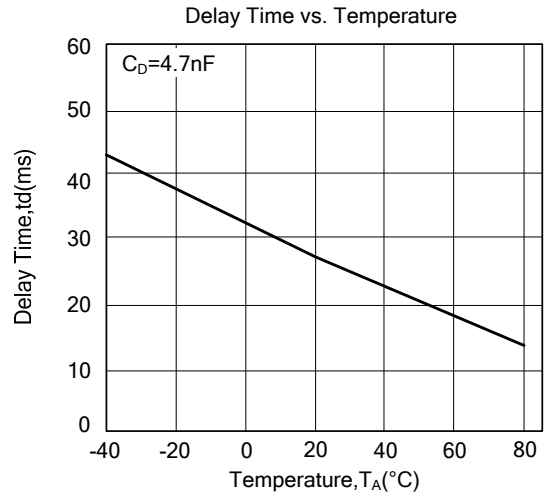
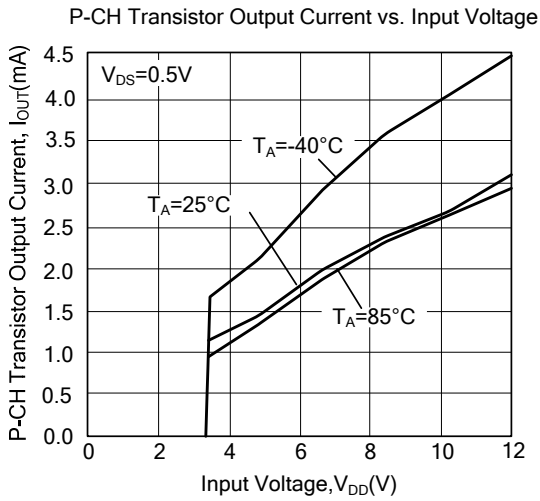
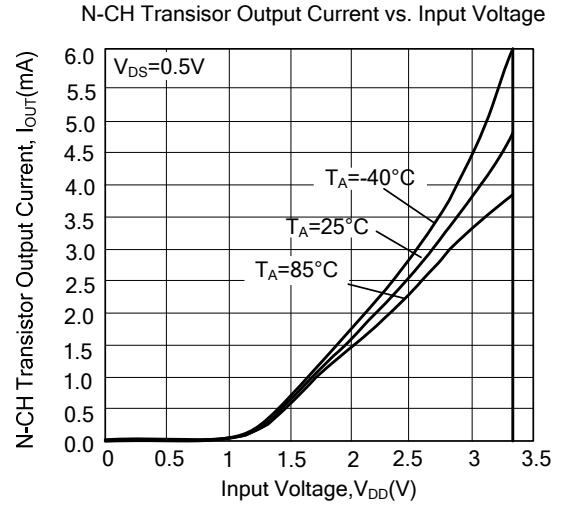
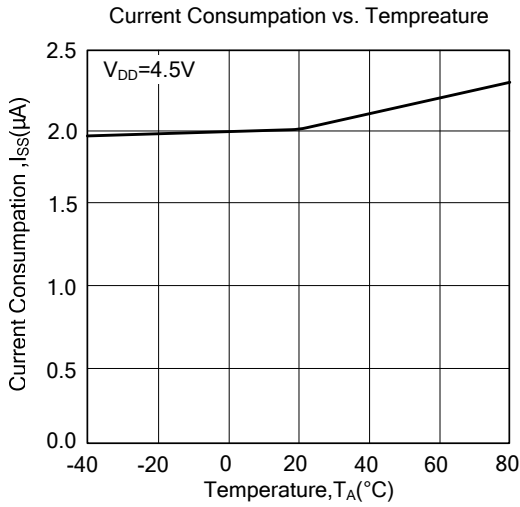

UTC assumes no responsibility for equipment failures that result from using products at values that exceed, even momentarily, rated values (such as maximum ratings, operating condition ranges, or other parameters) listed in products specifications of any and all UTC products described or contained herein. UTC products are not designed for use in life support appliances, devices or systems where malfunction of these products can be reasonably expected to result in personal injury. Reproduction in whole or in part is prohibited without the prior written consent of the copyright owner. UTC reserves the right to make changes to information published in this document, including without limitation specifications and product descriptions, at any time and without notice. This document supersedes and replaces all information supplied prior to the publication hereof.