

RFFM6900

2.5V TO 4.2V, ISM BAND, 1W
915MHz Transmit/Receive Module

The RFFM6900 is a single-chip front end module (FEM) for applications in the 900MHz and 868MHz ISM Bands. The RFFM6900 addresses the need for aggressive size reduction for typical portable equipment RF front end design and greatly reduces the number of components outside of the core chipset thus minimizing the footprint and assembly cost of the overall solution. The RFFM6900 contains an integrated 1 Watt PA, SP3T antenna switch, integrated Tx harmonic filter, Tx thru path, LNA with bypass mode, and matching components. The RFFM6900 is packaged in a 28-pin, 6.0mm x 6.0mm x 0.975mm over-molded laminate package with backside ground which greatly minimizes next level board space and allows for simplified integration.



Package: LGA, 28-Pin, 6.0mm x 6.0mm x 0.975mm

Features

- Integrated 50Ω Input/Output Match
- Tx Output Power: 30dBm
- Separate Tx/Rx 50 Ω transceiver interface
- Integrated PA, filtering LNA with Bypass Mode
- Transmit Thru Path

Applications

- 868MHz/900MHz ISM Bands
- Single Chip RF Front End
- Wireless Automatic Metering
- Portable Battery Powered Equipment
- Smart Energy

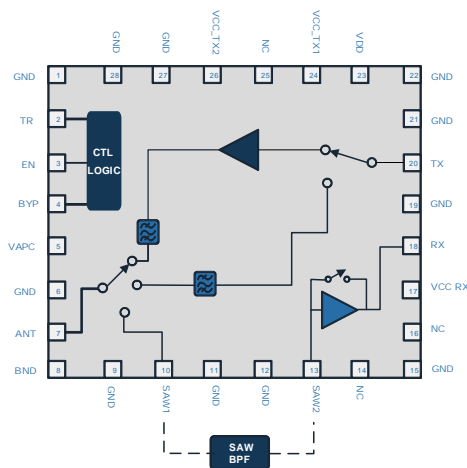

Functional Block Diagram

Ordering Information

RFFM6900SB	Standard 5 piece bag
RFSW6900SQ	Standard 25 piece bag
RFSW6900SR	Standard 100 piece reel
RFFM6900TR13	Standard 2500 piece reel
RFFM6900PCBA-410	Fully assembled evaluation board

Absolute Maximum Ratings

Parameter	Rating	Unit
Voltage	5.25	V
Storage Temperature Range	-40 to +150	°C
Operating Temperature Range	-40 to +85	°C
Receive RF Input Power (SAW2)	+5	dBm
Transmit RF Input Power (PA Enabled)	+15	dBm
Transmit RF Input Power (PA Bypass)	+20	dBm
Receive RF Input Power (ANT)	+33	dBm
T/R Port Load VSWR in Transmit Mode	10:1	
ESD, HBM	350	V
ESD, CDM	300	V
Moisture Sensitivity Level	MSL3	



Caution! ESD sensitive device.



RFMD Green: RoHS status based on EU Directive 2011/65/EU (at time of this document revision), halogen free per IEC 61249-2-21, < 1000ppm each of antimony trioxide in polymeric materials and red phosphorus as a flame retardant, and <2% antimony in solder.

Exceeding any one or a combination of the Absolute Maximum Rating conditions may cause permanent damage to the device. Extended application of Absolute Maximum Rating conditions to the device may reduce device reliability. Specified typical performance or functional operation of the device under Absolute Maximum Rating conditions is not implied.

Nominal Operating Parameters

Parameter	Specification			Unit	Condition
	Min	Typ	Max		
General Performance					
Frequency*	890	925	960	MHz	
RF Port Impedance		50		Ω	
Operating Voltage	2.5	3.6	4.2	V	
Leakage Current					
					$V_{CC}Tx1 = 3.6V, V_{CC}Tx2 = 3.6V, V_{DD} = 3.6V, V_{CC}Rx = 3.6V, V_{APC} = 0.0V, EN = 0.0V, T_R = 0.0V, BYP = 0.0V, RF = Off, \text{Temperature} = 25^{\circ}C$
V_{DD}		0.05	1	μA	
$V_{CC} TX$		0.05	1	μA	
$V_{CC} RX$		0.05	1	μA	
Operating Voltages					
$V_{CC} TX1/2$	2.5	3.6	4.2	V	
$V_{CC} RX$	2.5	3.3	4.2	V	
V_{DD}	2.5	3.6	4.2	V	
Tx Output Power Control (V_{APC})	0.00	2.25	2.50	V	V_{APC} operates such that the transmitter output power is saturated at a level lower than 1.9V and minimal variation in output power of the device occurs above that level
Transmit High Power Mode					
					$V_{CC}Tx1 = 3.6V, V_{CC}Tx2 = 3.6V, V_{DD} = 3.6V, V_{CC}Rx = 0.0V, V_{APC} = 2.25V, EN = 1.8V, T_R = 1.8V, BYP = 0.2V, \text{Measured Path} = TX \text{ to ANT}, \text{Temperature} = 25^{\circ}C$
Output Power	30.0	30.5		dBm	$V_{CC}Tx1, V_{CC}Tx2 = 3.6V, PIN = +10dBm$
	28				$V_{CC}Tx1, V_{CC}Tx2 = 2.7V, PIN = +10dBm$
Input Return Loss	10	15		dB	

Parameter	Specification			Unit	Condition
	Min	Typ	Max		
Transmit High Power Mode					$V_{CC}Tx1 = 3.6V, V_{CC}Tx2 = 3.6V, V_{DD} = 3.6V, V_{CC}Rx = 0.0V, V_{APC} = 2.25V, EN = 1.8V, T_R = 1.8V, BYP = 0.2V, \text{Measured Path} = TX \text{ to ANT}, \text{Temperature} = 25^\circ C$
Output Return Loss	15	20		dB	
Operating Current		650	700	mA	$P_{OUT} = 30.5dBm, I_{CC} TX1 + I_{\mu} TX2$
Quiescent Current		120		mA	$I_{CC} TX1 + I_{CC} TX2, RF = \text{Off}$
Quiescent Current (IDD)		7		mA	
Quiescent Current (ICC_RX)		11.5		μA	
IDD			13	mA	$P_{OUT} = 30.5dBm$
Second Harmonic		-40	-30	dBc	$P_{OUT} = 30.5dBm$
Third - Tenth Harmonic		-63	-60	dBc	$P_{OUT} = 30.5dBm$
Gain	20			dB	$V_{CC}Tx1, V_{CC}Tx2 = 3.6V, PIN = +10dBm$
	18			dB	$V_{CC}Tx1, V_{CC}Tx2 = 2.7V, PIN = +10dBm$
Module PAE		47		%	$V_{CC}Tx1, V_{CC}Tx2 = 3.6V, P_{OUT} = 30.5dBm, T=25^\circ C$ (take into account filter and switches)
Transmit Bypass Mode					$V_{CC}Tx1 = 3.6V, V_{CC}Tx2 = 3.6V, V_{DD} = 3.6V, V_{CC}Rx = 0.0V, V_{APC} = 0.0V, EN = 1.8V, T_R = 1.8V, BYP = 1.8V, \text{Measured Path} = TX \text{ to ANT}, \text{Temperature} = 25^\circ C$
Insertion Loss		2.0	2.7	dB	$P_{IN} = +5dBm$
Input P1dB	27	28		dBm	
Input IP3		41		dBm	
Input Return Loss	18			dB	
Output Return Loss	13.5			dB	
Second Harmonic Attenuation			-46	dB	$P_{IN} = +12dBm, \text{Second Harmonic Insertion Loss}$
Third - Tenth Harmonic			-47	dB	$P_{IN} = +12dBm, \text{Third - Tenth Harmonic Insertion Loss}$
Receive Mode					$V_{CC}Tx1 = 3.3V, V_{CC}Tx2 = 3.3V, V_{DD} = 3.3V, V_{CC}Rx = 3.3V, V_{APC} = .0V, EN = 1.8V, T_R = 0.2V, BYP = 0.2V, \text{Measured Path} = SAW2 \text{ to RX}, \text{Temperature} = 25^\circ C$
IP1dB		-2.5		dBm	
Gain	14.5	15.5	16.0	dB	
Current	4	5	6	mA	
IDD		150		μA	
Noise Figure		1.7	2.0	dB	
IIP3	1.4	3.0		dBm	
Input Return Loss	18			dB	
Output Return Loss	10			dB	

Parameter	Specification			Unit	Condition
	Min	Typ	Max		
Receive Bypass Mode					$V_{CC\text{Tx}1} = 3.3\text{V}$, $V_{CC\text{Tx}2} = 3.3\text{V}$, $V_{DD} = 3.3\text{V}$, $V_{CC\text{Rx}} = 3.3\text{V}$, $V_{APC} = .0\text{V}$, $EN = 1.8\text{V}$, $T_R = 0.2\text{V}$, $BYP = 1.8\text{V}$, Measured Path = SAW2 to RX, Temperature = 25°C
Insertion Loss	1.0	1.2	1.4	dB	
Current		90		μA	
IP1dB		17.5		dBm	
IIP3		42		dBm	
Input Return Loss	11			dB	
Output Return Loss	14			dB	
Antenna Switch					Measured ANT to SAW1, RX & RX BYPASS Modes
Insertion Loss		0.5		dB	
Input Return Loss	9	10		dB	
Output Return Loss	9	10		dB	
Isolation					
Isolation	24			dB	ANT to SAW1 (Module in TX BYP Mode)
	44			dB	ANT to SAW1 (Module in TX Mode)
Logic					EN, TR, BYP
Control Logic HIGH	1.6		4.0	V	Max Control Logic High = $V_{DD} - 0.2V_{Dc}$
Control Logic LOW		0.2	0.3	V	
Control Logic HIGH Current		0.1		μA	
Control Logic LOW Current		0.1		μA	
VAPC High Current		50		μA	Across all rated voltages at rated power

*868MHz data available upon request

Switch Control Logic Table

Operating Mode	TR	EN	BYP	PA	LNA
	(Pin2)	(Pin3)	(Pin4)		
Transmit	High	High	Low	ON	OFF
Transmit Bypass	High	High	High	OFF	OFF
Receive	Low	High	Low	OFF	ON
Receive Bypass	Low	High	High	OFF	OFF
Shutdown	X	Low	X	OFF	OFF

Pin Out

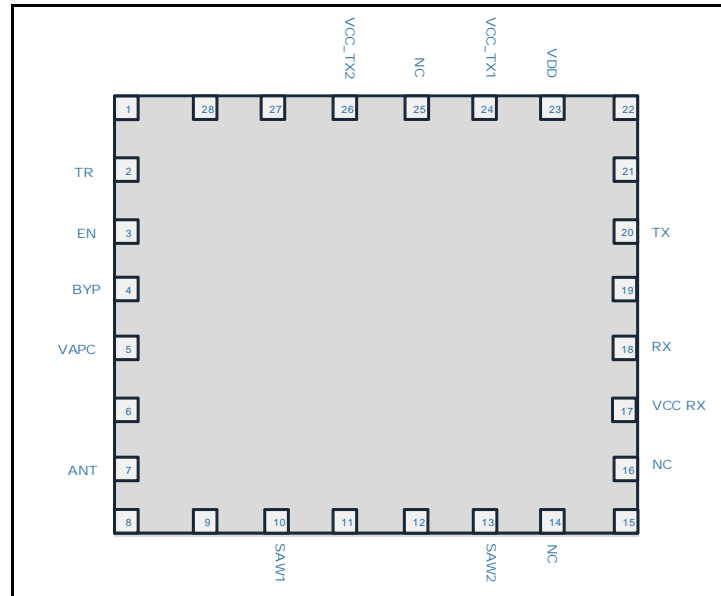

Package Drawing

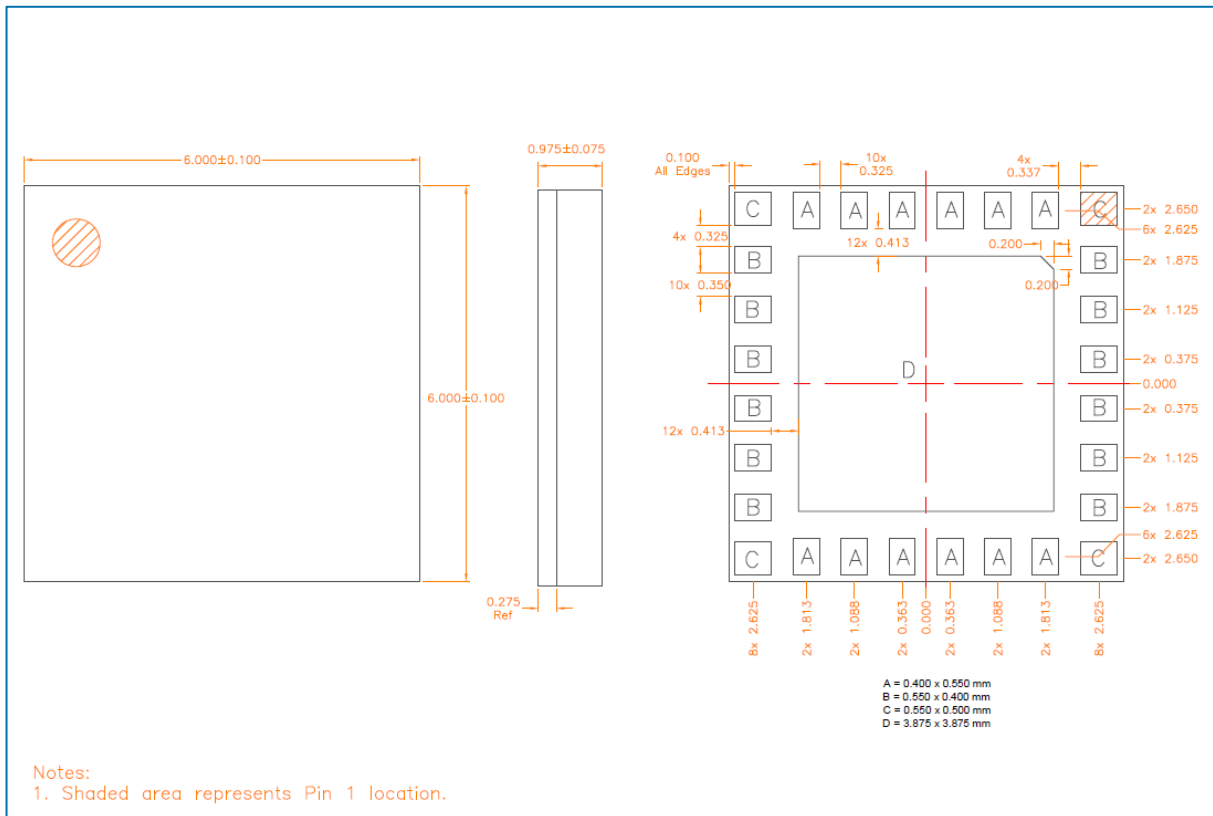

PCB Patterns Drawing

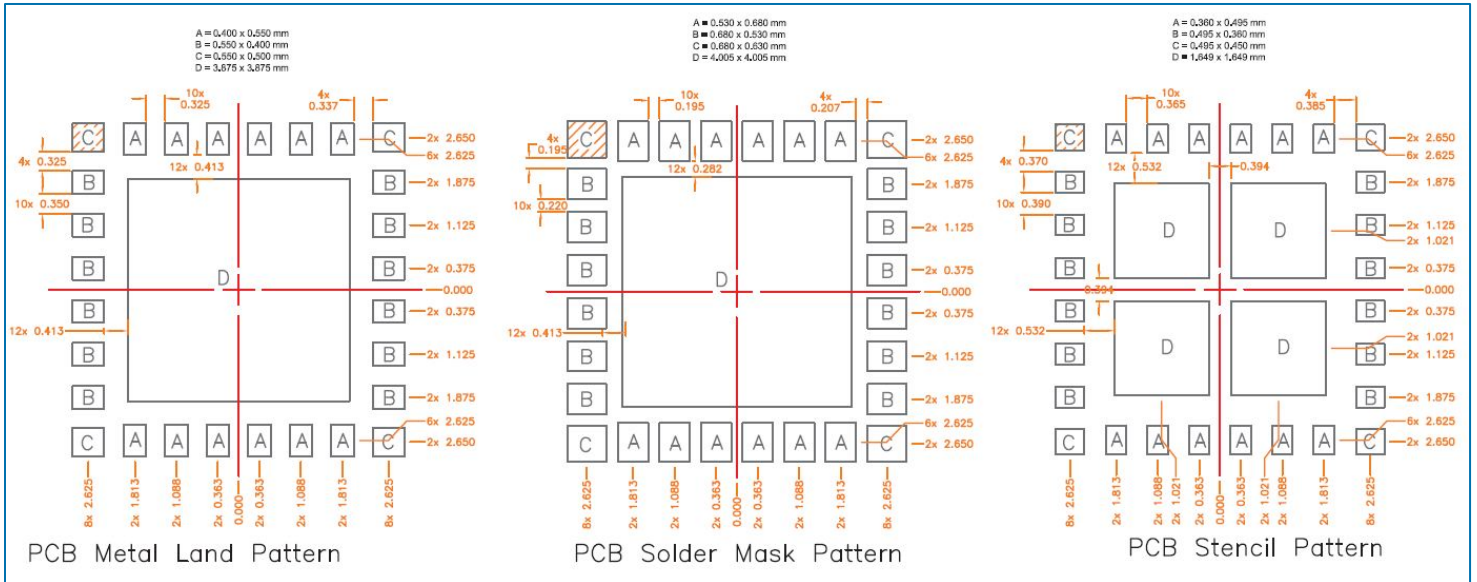

Notes:

1. Shaded area represents Pin1 location.

Application Board Schematic

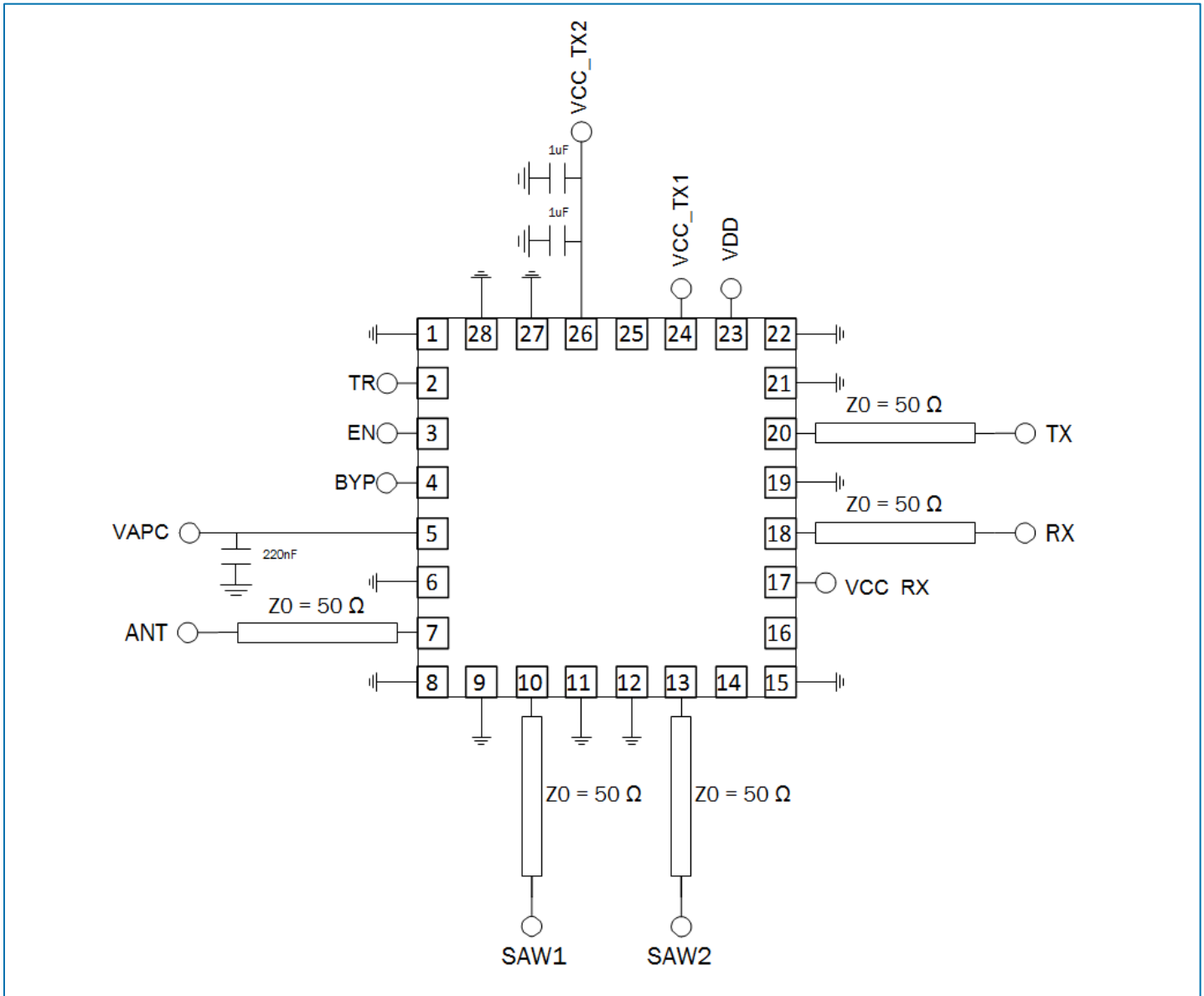

Typical Performance

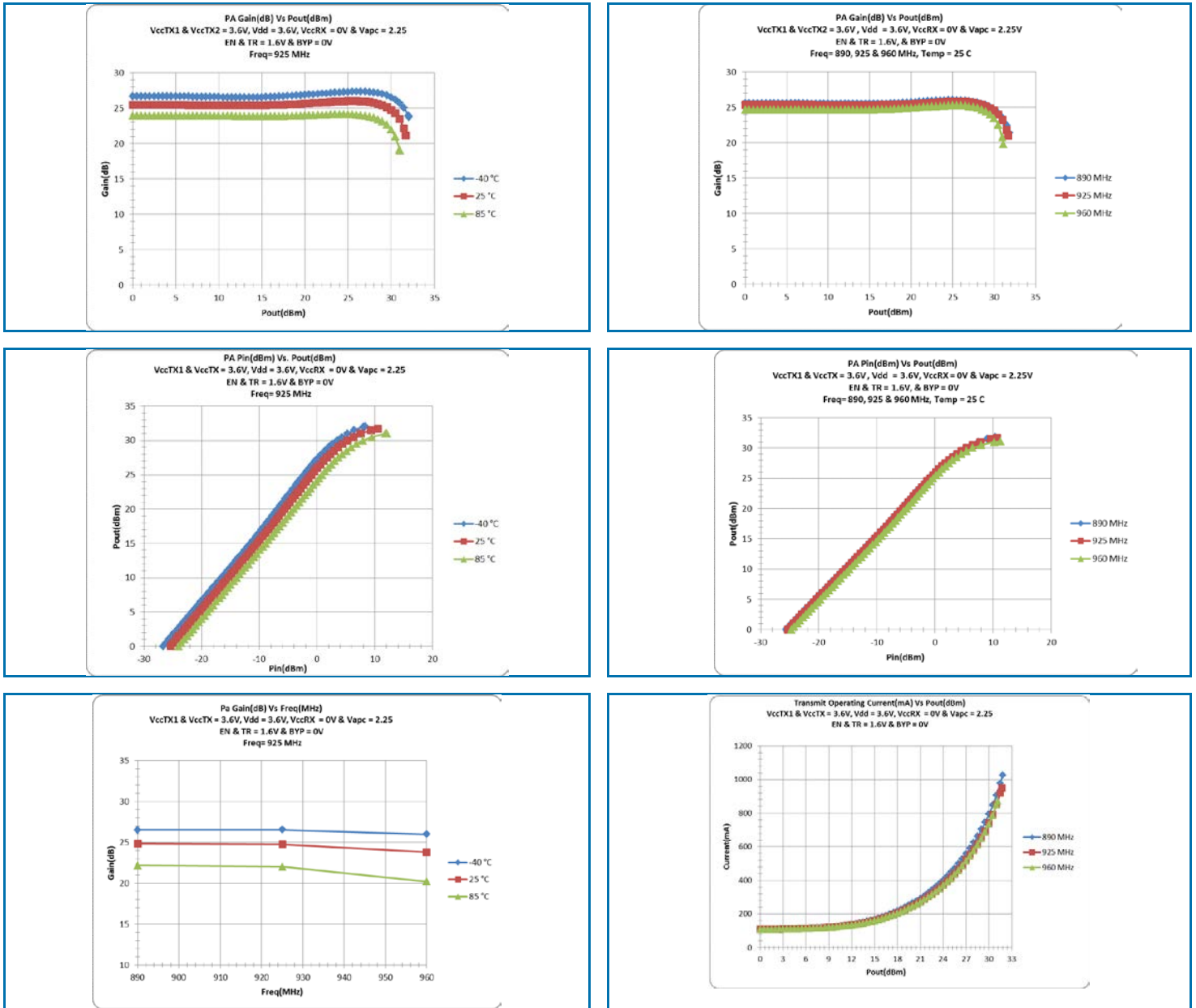

Typical Performance

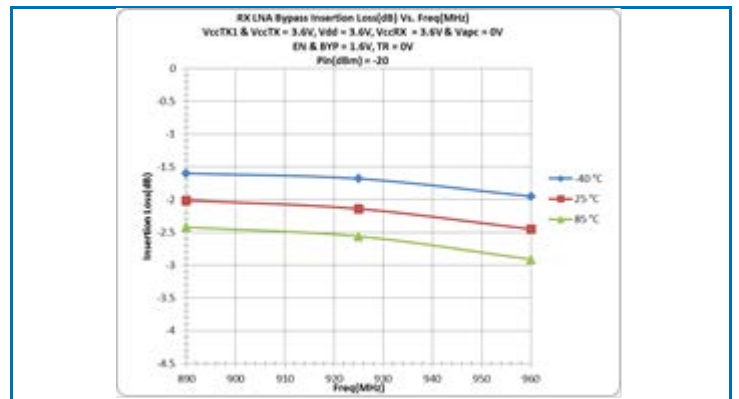
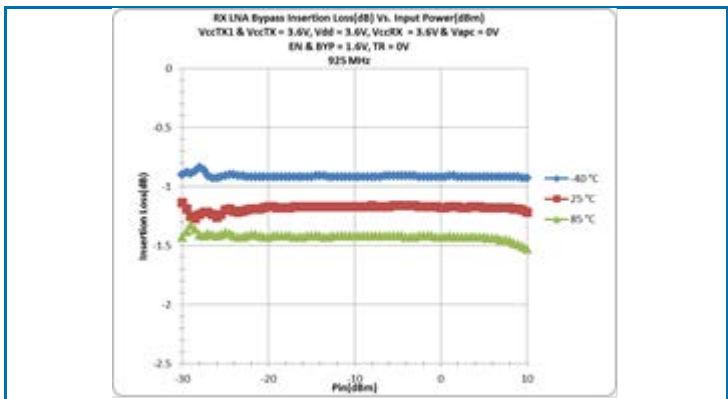
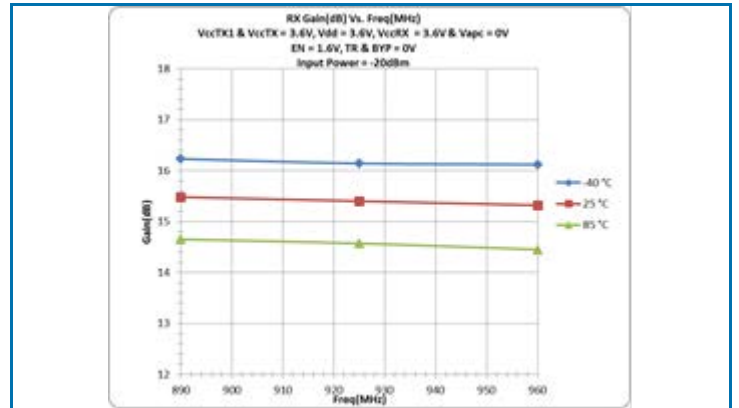
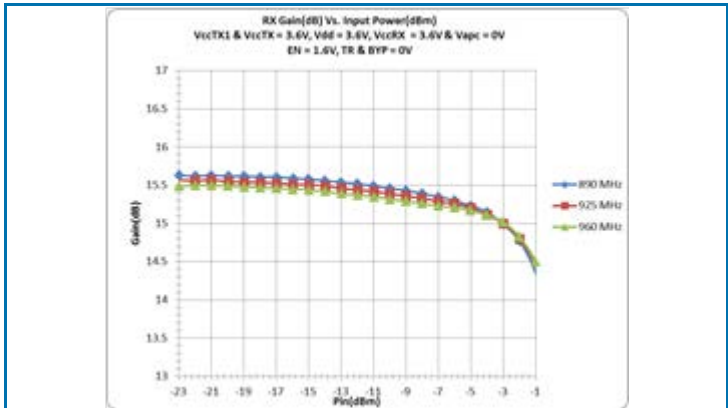
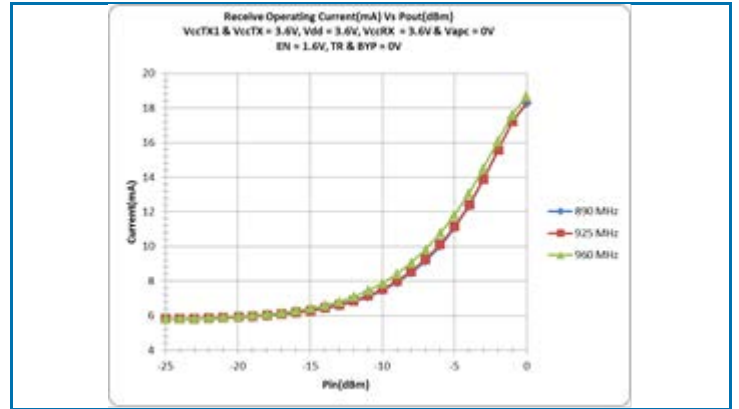
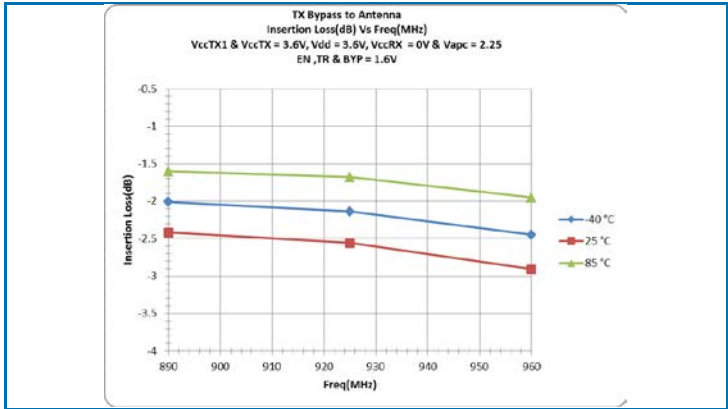

Typical Performance

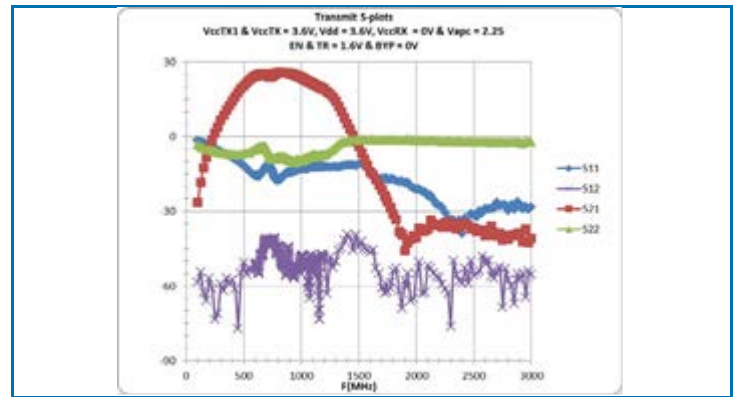
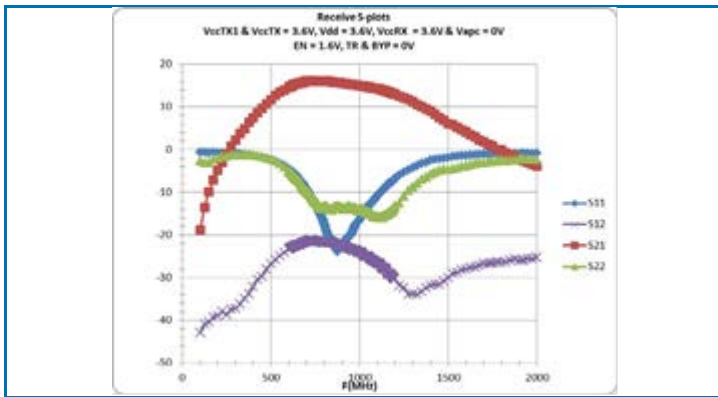

Pin Descriptions

Pin	Name	Description
1	GND	Ground
2	TR	Digital Input: Transmit/Receive
3	EN	Digital Input: Shutdown Mode
4	BYP	Digital Input: RX Bypass Control
5	VAPC	Analog Input
6	GND	Ground
7	ANT	Antenna Switch CommonPort, internally matched to 50Ω, DC blocked
8	GND	Ground
9	GND	Ground
10	SAW1	Receive side of antenna switch, internally matched to 50Ω, DC blocked
11	GND	Ground
12	GND	Ground
13	SAW2	RX and RX bypass input port, internally matched to 50Ω, DC blocked
14	NC	Not internally connected/open
15	GND	Ground
16	NC	Not internally connected/open
17	VCC_RX	3.3V power supply
18	RX	Receive output, internally matched to 50Ω, DC blocked
19	GND	Ground
20	TX	TX and TX bypass input port, internally matched to 50Ω, DC blocked
21	GND	Ground
22	GND	Ground
23	VDD	3.6V power supply
24	VCC_TX1	3.6V power supply
25	NC	Not internally connected/open
26	VCC_TX2	3.6V power supply
27	GND	Ground
28	GND	Ground