

## High Efficient Surface Mount Rectifiers

### FEATURES

- Glass passivated junction chip
- Ideal for automated placement
- Low profile package
- Fast switching for high efficiency
- Moisture sensitivity level: level 1, per J-STD-020
- Compliant to RoHS Directive 2011/65/EU and in accordance to WEEE 2002/96/EC
- Halogen-free according to IEC 61249-2-21 definition

**DO-214AC(SMA)**

### MECHANICAL DATA

**Case:** DO-214AC (SMA)

Molding compound, UL flammability classification rating 94V-0

Base P/N with suffix "G" on packing code - Green compound (halogen-free)

Base P/N with prefix "H" on packing code - AEC-Q101 qualified

**Terminal:** Matte tin plated leads, solderable per JESD22-B102

Meet JESD 201 class 1A whisker test

with prefix "H" on packing code meet JESD 201 class 2 whisker test

**Polarity:** Indicated by cathode band

**Weight:** 0.06 g (approximately)

MAXIMUM RATINGS AND ELECTRICAL CHARACTERISTICS (T <sub>A</sub> =25°C unless otherwise noted)											
PARAMETER	SYMBOL	HS 2AA	HS 2BA	HS 2DA	HS 2FA	HS 2GA	HS 2JA	HS 2KA	HS 2MA	UNIT	
Maximum repetitive peak reverse voltage	V <sub>RRM</sub>	50	100	200	300	400	600	800	1000	V	
Maximum RMS voltage	V <sub>RMS</sub>	35	70	140	210	280	420	560	700	V	
Maximum DC blocking voltage	V <sub>DC</sub>	50	100	200	300	400	600	800	1000	V	
Maximum average forward rectified current	I <sub>F(AV)</sub>	1.5								A	
Peak forward surge current, 8.3 ms single half sine-wave superimposed on rated load	I <sub>FSM</sub>	50								A	
Maximum instantaneous forward voltage (Note 1) @ 1.5 A	V <sub>F</sub>	1.0			1.3		1.7			V	
Maximum reverse current @ rated VR T <sub>J</sub> =25 °C T <sub>J</sub> =125 °C	I <sub>R</sub>	5 100								μA	
Maximum reverse recovery time (Note 2)	T <sub>rr</sub>	50					75				ns
Typical junction capacitance (Note 3)	C <sub>j</sub>	50					30				pF
Typical thermal resistance	R <sub>θJA</sub>	80								°C/W	
Operating junction temperature range	T <sub>J</sub>	- 55 to +150								°C	
Storage temperature range	T <sub>STG</sub>	- 55 to +150								°C	

Note 1: Pulse test with PW=300μs, 1% duty cycle

Note 2: Reverse Recovery Test Conditions: I<sub>F</sub>=0.5A, I<sub>R</sub>=1.0A, I<sub>RR</sub>=0.25A

Note 3: Measured at 1 MHz and Applied Reverse Voltage of 4.0V D.C.

ORDERING INFORMATION					
PART NO.	AEC-Q101 QUALIFIED	PACKING CODE	GREEN COMPOUND CODE	PACKAGE	PACKING
HS2xA (Note 1)	Prefix "H"	R3	Suffix "G"	SMA	1,800 / 7" Plastic reel
		R2		SMA	7,500 / 13" Paper reel
		M2		SMA	7,500 / 13" Plastic reel
		F3		Folded SMA	1,800 / 7" Plastic reel
		F2		Folded SMA	7,500 / 13" Paper reel
		F4		Folded SMA	7,500 / 13" Plastic reel
	N/A	E3		Clip SMA	1,800 / 7" Plastic reel
		E2		Clip SMA	7,500 / 13" Plastic reel

Note 1: "x" defines voltage from 50V (HS2AA) to 1000V (HS2MA)

EXAMPLE					
PREFERRED P/N	PART NO.	AEC-Q101 QUALIFIED	PACKING CODE	GREEN COMPOUND CODE	DESCRIPTION
HS2MA R3	HS2MA		R3		
HS2MA R3G	HS2MA		R3	G	Green compound
HS2MAHR3	HS2MA	H	R3		AEC-Q101 qualified

**RATINGS AND CHARACTERISTICS CURVES**

(TA=25°C unless otherwise noted)

FIG. 1 FORWARD CURRENT DERATING CURVE

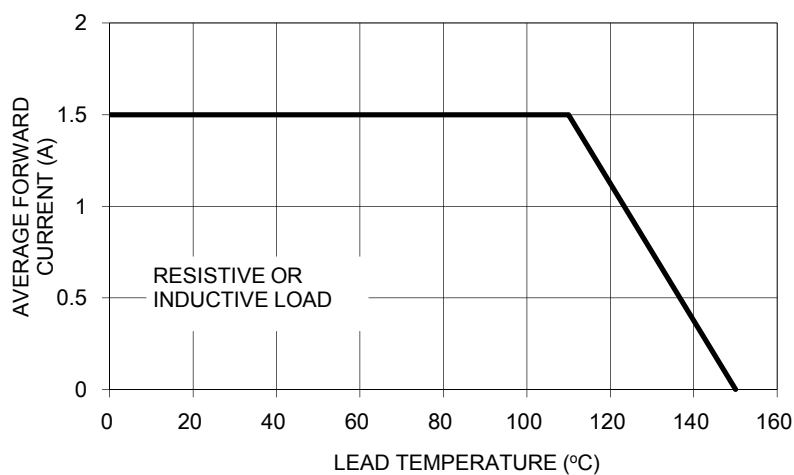

FIG. 2 TYPICAL REVERSE CHARACTERISTICS

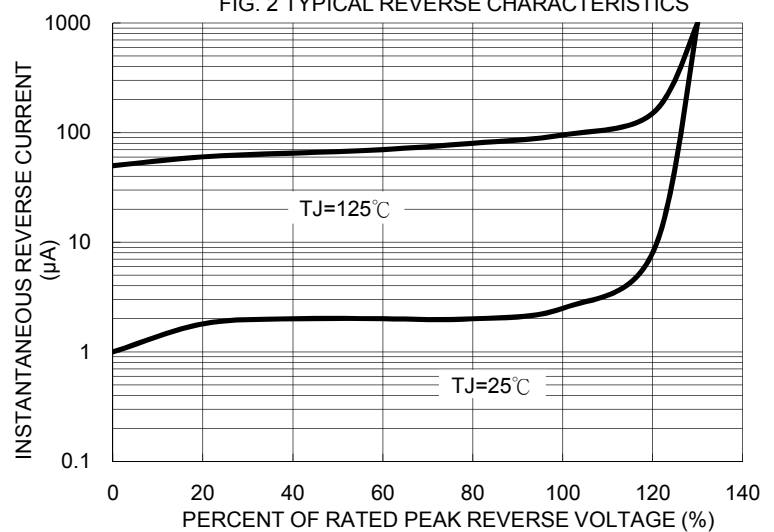

FIG. 3 MAXIMUM NON-REPETITIVE FORWARD SURGE CURRENT

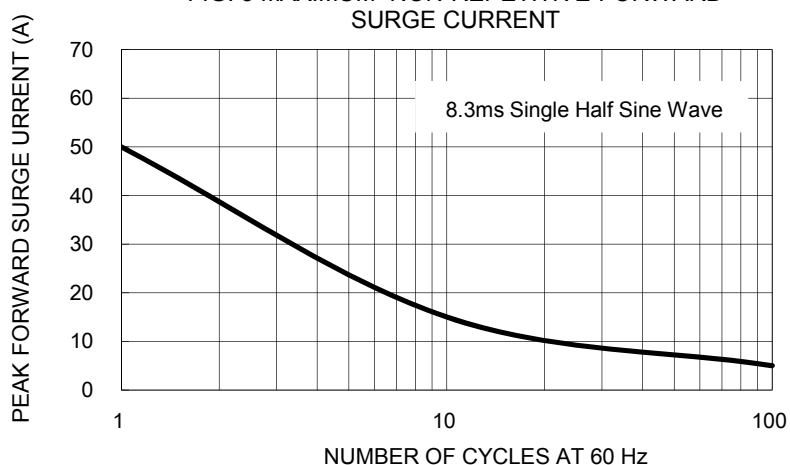

FIG. 4 TYPICAL FORWARD CHARACTERISTICS

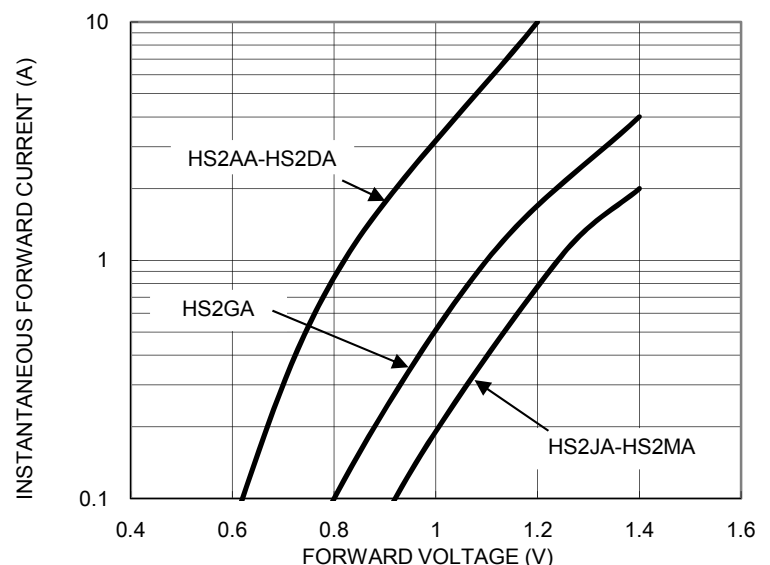

FIG. 5 TYPICAL JUNCTION CAPACITANCE

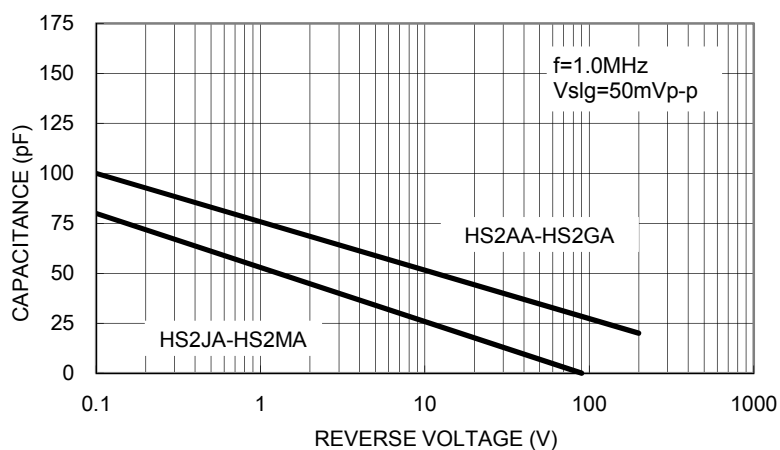
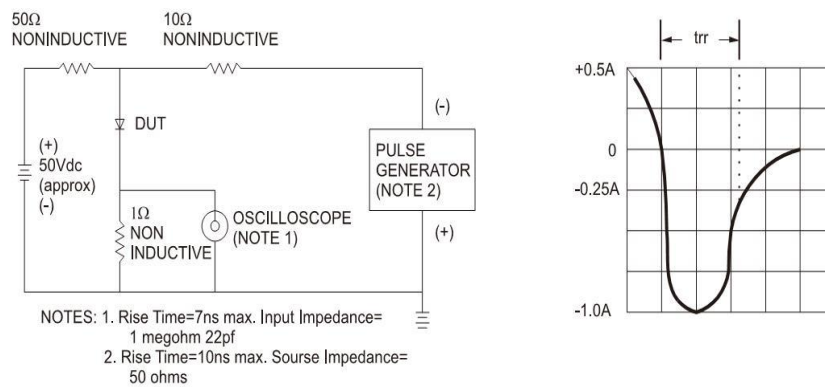
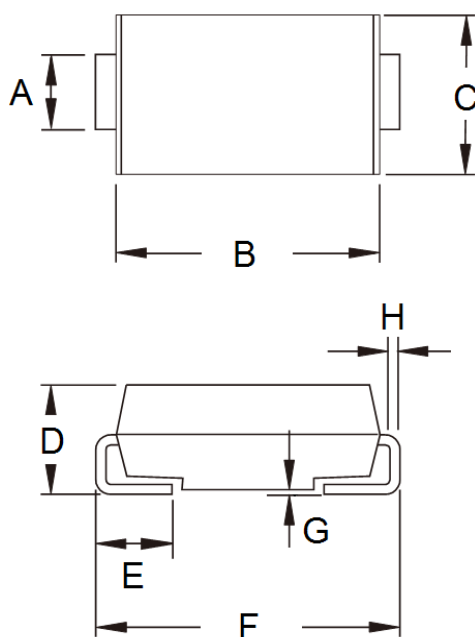

FIG.6- REVERSE RECOVERY TIME CHARACTERISTIC AND TEST CIRCUIT DIAGRAM



PACKAGE OUTLINE DIMENSIONS



DIM.	Unit (mm)		Unit (inch)	
	Min	Max	Min	Max
A	1.27	1.58	0.050	0.062
B	4.06	4.60	0.160	0.181
C	2.29	2.83	0.090	0.111
D	1.99	2.50	0.078	0.098
E	0.90	1.41	0.035	0.056
F	4.95	5.33	0.195	0.210
G	0.10	0.20	0.004	0.008
H	0.15	0.31	0.006	0.012

SUGGESTED PAD LAYOUT

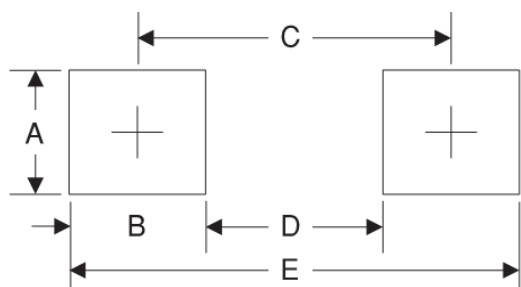

Symbol	Unit (mm)	Unit (inch)
A	1.68	0.066
B	1.52	0.060
C	3.93	0.155
D	2.41	0.095
E	5.45	0.215

MARKING DIAGRAM



- P/N = Specific Device Code
- G = Green Compound
- YW = Date Code
- F = Factory Code

## Notice

Specifications of the products displayed herein are subject to change without notice. TSC or anyone on its behalf, assumes no responsibility or liability for any errors inaccuracies.

Information contained herein is intended to provide a product description only. No license, express or implied, to any intellectual property rights is granted by this document. Except as provided in TSC's terms and conditions of sale for such products, TSC assumes no liability whatsoever, and disclaims any express or implied warranty, relating to sale and/or use of TSC products including liability or warranties relating to fitness for a particular purpose, merchantability, or infringement of any patent, copyright, or other intellectual property right.

The products shown herein are not designed for use in medical, life-saving, or life-sustaining applications. Customers using or selling these products for use in such applications do so at their own risk and agree to fully indemnify TSC for any damages resulting from such improper use or sale.